



Features

- 5V Single Supply
- Excellent Linearity Performance at +34dBmV Output Power per Tone
- Two Amplifiers in Each SOIC-8 Package Simplify Push-Pull Configuration PC Board Layout
- Available in Lead-free, RoHS Compliant, and Green Packaging
- SOIC-8 Package

Applications

- CATV Head End Driver and Predriver Amplifier
- CATV Line Driver Amplifier

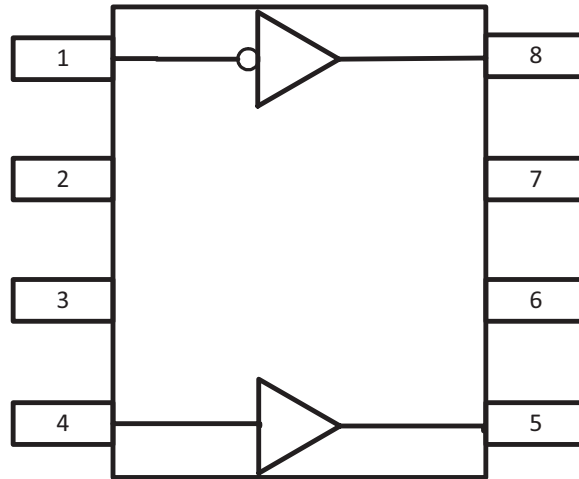

Functional Block Diagram

Product Description

RFMD's RFCA1008 is a high performance InGaP HBT MMIC amplifier designed with the InGaP process technology for excellent reliability. The heterojunction increases breakdown voltage and minimizes leakage current between junctions. A Darlington configuration is utilized for broadband performance. The RFCA1008 contains two amplifiers for use in wideband push-pull CATV amplifiers requiring excellent second order performance; the second and third order non-linearities are greatly improved in the push-pull configuration.

Ordering Information

RFCA1008SQ	25 Piece sample bag
RFCA1008SR	7" Sample reel with 100 pieces
RFCA1008TR13	13" Reel with 2500 pieces
RFCA1008PCK-410	50MHz to 1000MHz, PCBA with 5-piece sample bag

Optimum Technology Matching® Applied

- | | | | |
|---|--------------------------------------|-------------------------------------|------------------------------------|
| <input type="checkbox"/> GaAs HBT | <input type="checkbox"/> SiGe BiCMOS | <input type="checkbox"/> GaAs pHEMT | <input type="checkbox"/> GaN HEMT |
| <input type="checkbox"/> GaAs MESFET | <input type="checkbox"/> Si BiCMOS | <input type="checkbox"/> Si CMOS | <input type="checkbox"/> BiFET HBT |
| <input checked="" type="checkbox"/> InGaP HBT | <input type="checkbox"/> SiGe HBT | <input type="checkbox"/> Si BJT | <input type="checkbox"/> SOI |

RF MICRO DEVICES®, RFMD®, Optimum Technology Matching®, Enabling Wireless Connectivity™, PowerStar®, POLARIS™ TOTAL RADIO™ and UltimateBlue™ are trademarks of RFMD, LLC. BLUETOOTH is a trademark owned by Bluetooth SIG, Inc., U.S.A. and licensed for use by RFMD. All other trade names, trademarks and registered trademarks are the property of their respective owners. ©2012, RF Micro Devices, Inc.

Absolute Maximum Ratings

Parameter	Rating	Unit
Max Device Current (I_D)	300	mA
Max Device Voltage (V_D)	6	V
Max RF Input Power	18	dBm
Max Junction Temp (T_J)	150	°C
Operating Temperature Range (T_L)	-40 to +85	°C
Storage Temperature	-40 to +150	°C

Notes:

1. Operation of this device beyond any one of these limits may cause permanent damage. For reliable continuous operation, the device voltage and current must not exceed the maximum operating values specified in the Absolute Maximum Ratings table above.
2. Bias Conditions should also satisfy the following expression:

$$I_D V_D < (T_J - T_L) / R_{TH}, J - I \text{ and } T_L = T_{LEAD}$$



Caution! ESD sensitive device.

Exceeding any one or a combination of the Absolute Maximum Rating conditions may cause permanent damage to the device. Extended application of Absolute Maximum Rating conditions to the device may reduce device reliability. Specified typical performance or functional operation of the device under Absolute Maximum Rating conditions is not implied.

RoHS status based on EU Directive 2011/65/EU (at time of this document revision).

The information in this publication is believed to be accurate and reliable. However, no responsibility is assumed by RF Micro Devices, Inc. ("RFMD") for its use, nor for any infringement of patents, or other rights of third parties, resulting from its use. No license is granted by implication or otherwise under any patent or patent rights of RFMD. RFMD reserves the right to change component circuitry, recommended application circuitry and specifications at any time without prior notice.

Nominal Operating Parameters

Parameter	Specification			Unit	Condition
	Min.	Typ.	Max.		
					17dB Application, $V_{CC} = 5V, I_{CC} = 215mA$
Frequency Range	50		1000	MHz	
Small Signal Gain		16.8		dB	50MHz; 5V, 25 °C
		17.4		dB	500MHz; 5V, 25 °C
		17.9		dB	1000MHz; 5V, 25 °C
Gain Flatness		±0.5		dB	50MHz to 1000MHz per ANSI/SCTE-144 2007
Output IP3		40		dBm	550MHz, Tone Spacing = 6MHz, P_{OUT} per Tone = +5dBm
Output IP2 Plus		65		dBm	550MHz, Tone Spacing = 30MHz P_{OUT} per Tone = 0dB
Output IP2 Minus		70		dBm	
P1dB		23		dBm	500MHz
Input Return Loss		27		dB	
Output Return Loss		16		dB	
Noise Figure (Balun Insertion Loss Included)		4.0		dB	50MHz to 1000MHz
CSO		80		dBc	79 Channel, Flat Tilt, +34dBmV
CTB		76		dBc	
XMOD		69		dBc	
Device Operating Voltage		5.0		V	
Device Operating Current		215		mA	$V_{CC} = 5V$
Thermal Resistance		40		°C/W	Junction to backside PCB under IC

Note: $V_{CC} = 5V, I_C = 215mA, T_L = 25 °C, Z_S = Z_L = 75\Omega$, Push Pull Application Circuit

Parameter	Specification			Unit	Condition
	Min.	Typ.	Max.		
15dB Application, V _{CC} = 5V, I _{CC} = 150mA					
Frequency Range	50		1000	MHz	
Small Signal Gain		14.7		dB	50MHz; 5V, 25 °C
		15.5		dB	500MHz; 5V, 25 °C
		16.5		dB	1000MHz; 5V, 25 °C
Gain Flatness		±0.5		dB	50MHz to 1000MHz per ANSI/SCTE-144 2007
Output IP3		36		dBm	550MHz, Tone Spacing = 6MHz, P _{OUT} per Tone = +5dBm
Output IP2 Plus		60		dBm	550MHz, Tone Spacing = 30MHz P _{OUT} per Tone = 0dB
Output IP2 Minus		66		dBm	
P1dB		20		dBm	500MHz
Input Return Loss		20		dB	
Output Return Loss		20		dB	
Noise Figure (Balun Insertion Loss Included)		4.5		dB	50MHz to 1000MHz
CSO		77		dBc	79 Channel, Flat Tilt, +34dBmV
CTB		70		dBc	
XMOD		61		dBc	
Device Operating Voltage		5.0		V	
Device Operating Current		150		mA	V _{CC} = 5V
Thermal Resistance		40		°C/W	Junction to backside PCB under IC
17dB Application, V _{CC} = 5V, I _{CC} = 217mA					
Frequency Range	5		300	MHz	
Small Signal Gain		17.4		dB	150MHz; 5V, 25 °C
Gain Flatness		±0.2		dB	5MHz to 300MHz, 25 °C per ANSI/SCTE-144 2007
Output IP3		41		dBm	5MHz to 300MHz, Tone Spacing = 6MHz, P _{OUT} per Tone = +5dBm
Output IP2 Plus		73		dBm	150MHz, Tone Spacing = 6MHz P _{OUT} per Tone = 0dB
Output IP2 Minus		73		dBm	
P1dB		22		dBm	5MHz to 300MHz
Input Return Loss		22	16	dB	
Output Return Loss		22	14	dB	
Noise Figure (Balun Insertion Loss Included)		4.0		dB	5MHz to 210MHz
CSO		80		dBc	7 Channel, Flat Tilt, +50dBmV
CTB		67		dBc	
XMOD		66		dBc	
Device Operating Voltage		5.0		V	
Device Operating Current		217		mA	V _{CC} = 5V
Thermal Resistance		40		°C/W	Junction to backside PCB under IC

Performance 17dB Application Circuit $V_{CC} = 5V$, $I_{CC} = 215mA$

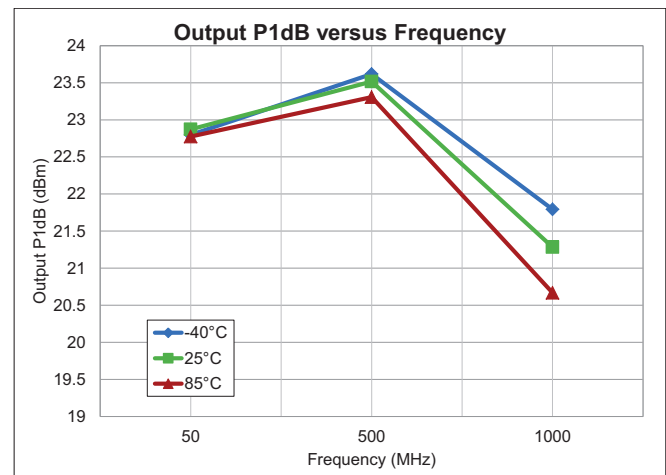
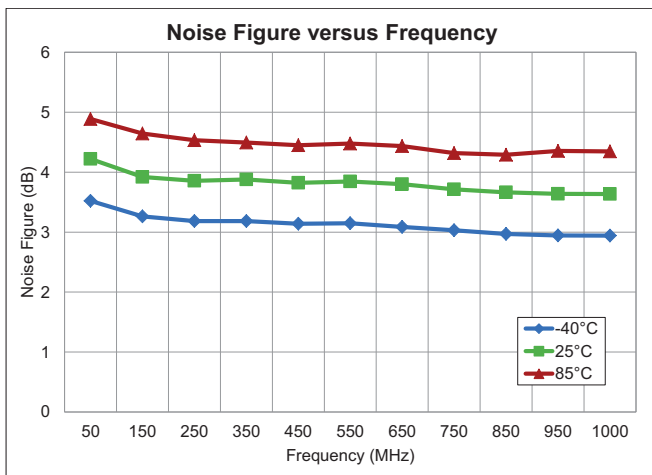
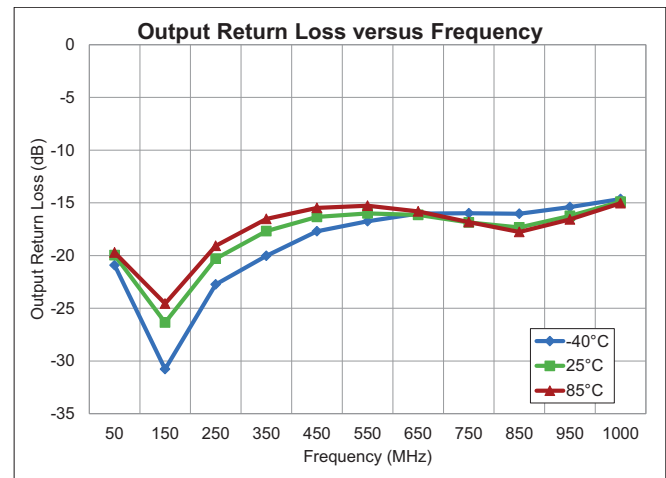
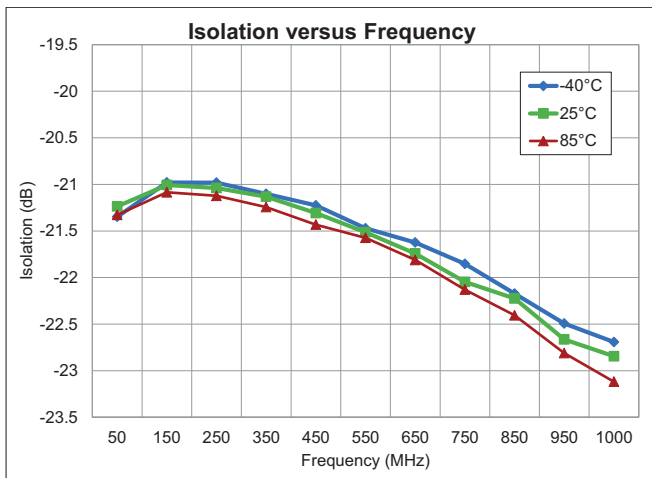
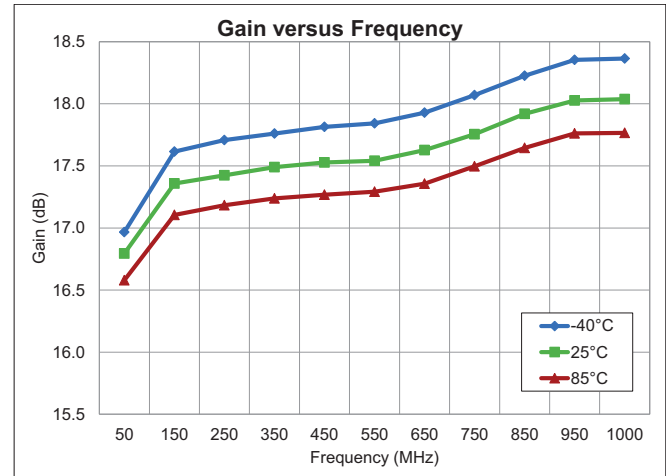
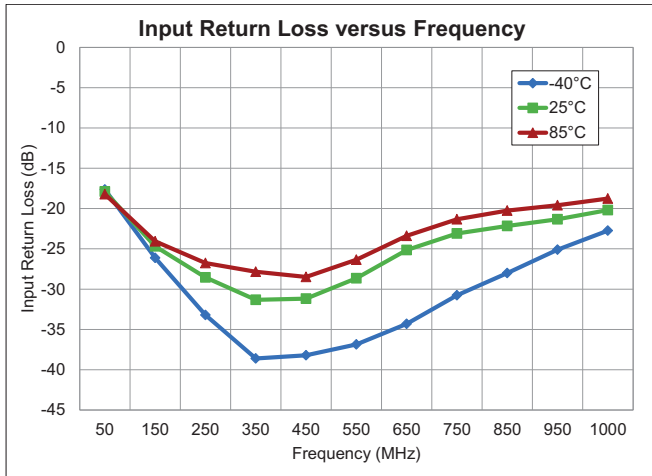

Performance 17dB Application Circuit $V_{CC} = 5V, I_{CC} = 215mA$

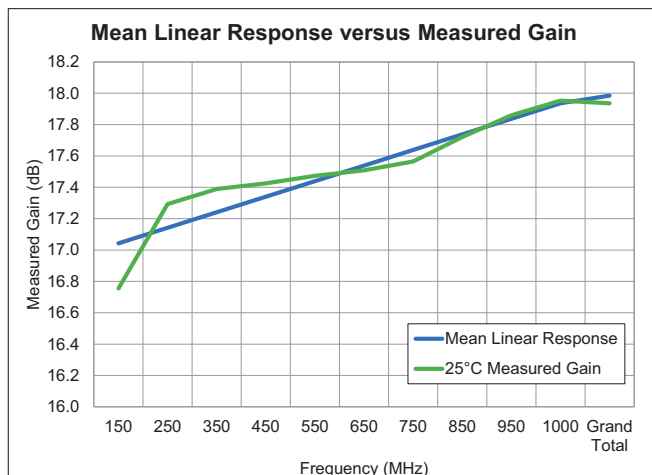
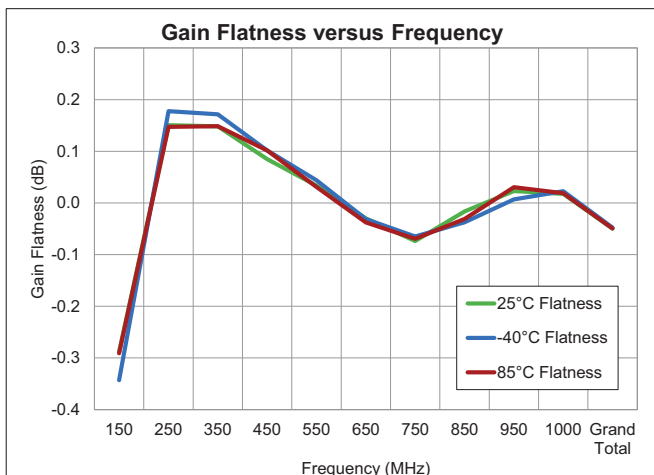
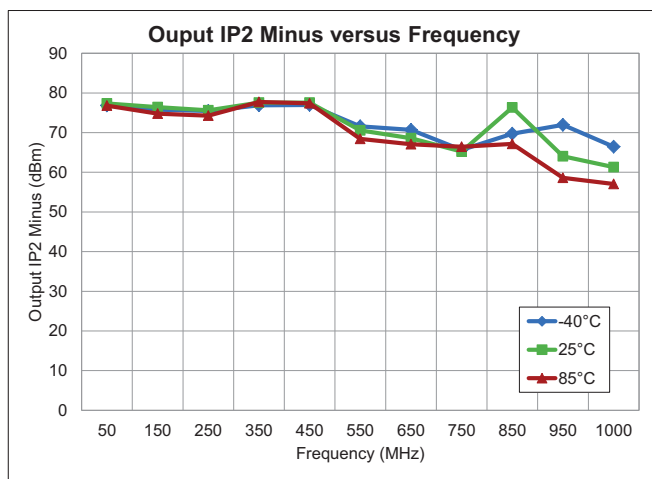
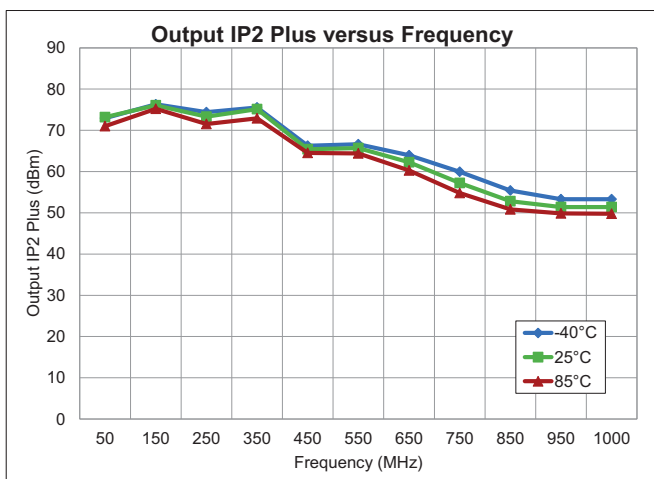
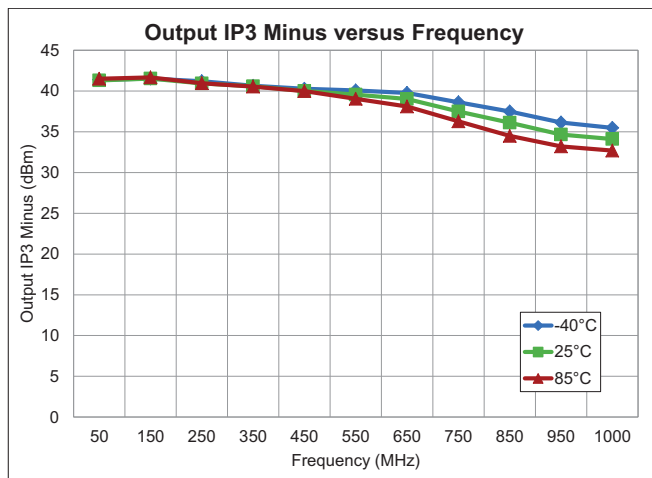
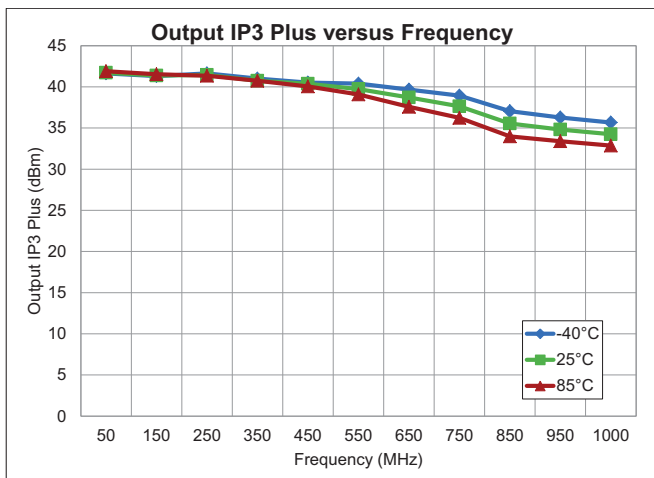

Performance 17dB Application Circuit $V_{CC} = 5V$, $I_{CC} = 215mA$

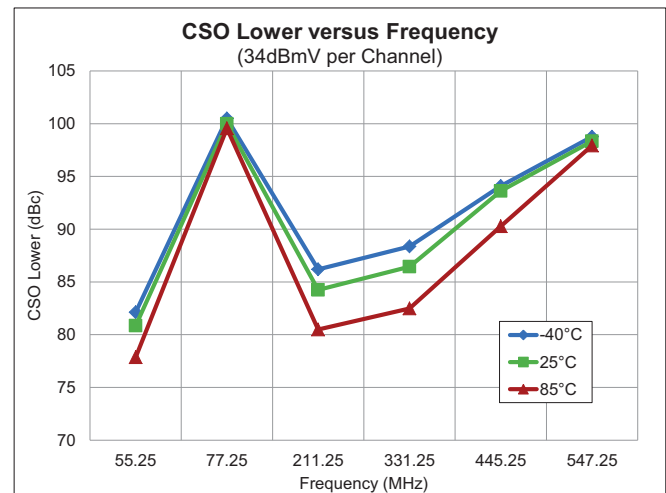
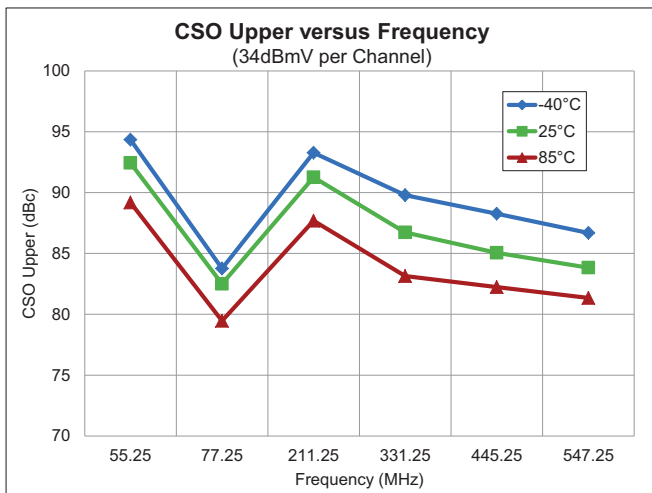
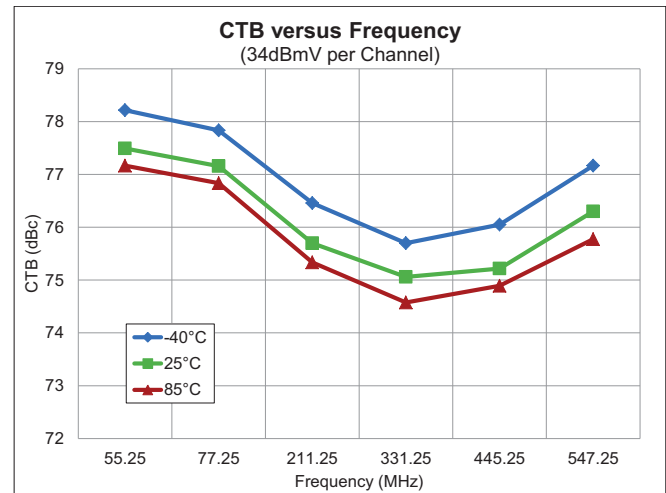
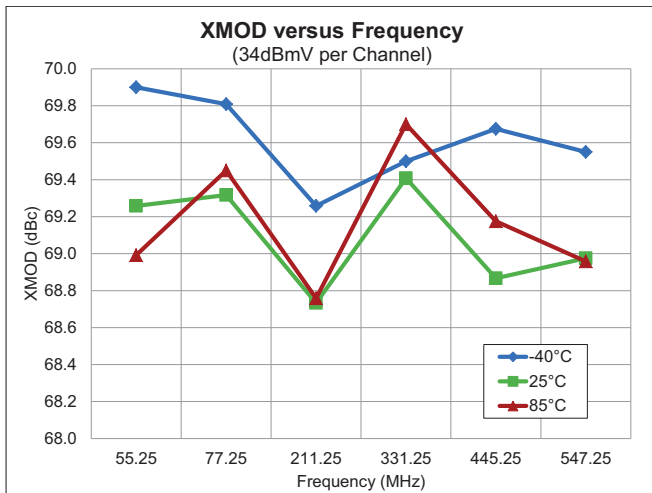

Evaluation Board Schematic
(17dB, 50MHz to 1000MHz Application Circuit)

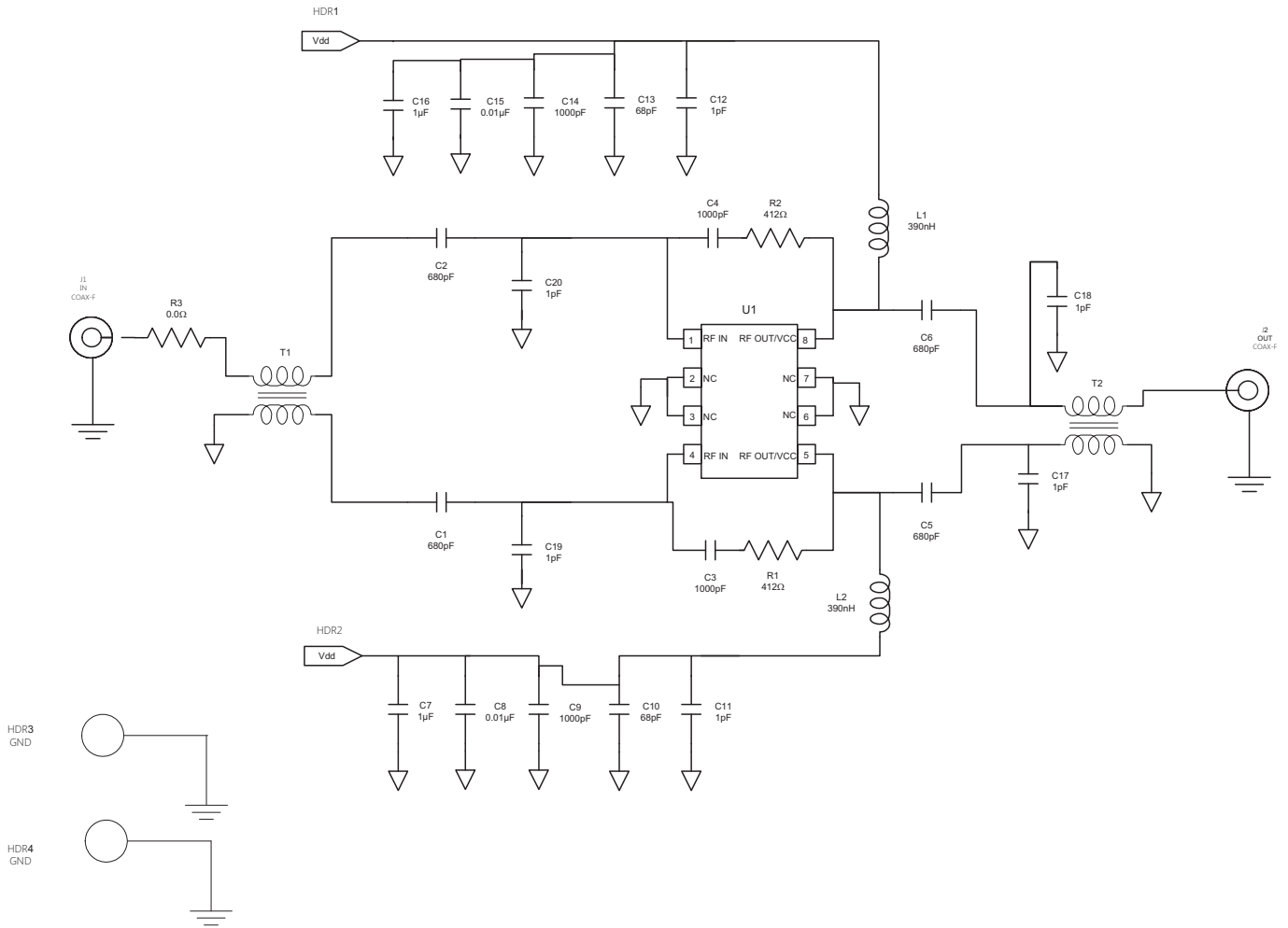

Evaluation Board Bill of Materials (BOM) (17dB, 50MHz to 1000MHz Application Circuit)

Description	Reference Designator	Manufacturer	Manufacturer's P/N
PCB, DEMO, 31MIL BALANCED SOIC-8 CATV GA		DDI	225107(B)
DUAL CATV 5MHz to 1000MHz HI LIN GaAs HBT	U1	RFMD	RFCA1008
CAP, 1pF, +/-0.25pF, 50V, CG, 0402	C19-C20	Taiyo Yuden (USA), Inc.	RM UMK105CG010CW-F
CAP, 1000pF, 10%, 50V, X7R, 0402	C3-C4	Murata Electronics	GRM155R71H102KA01E
CAP, 1pF, +/-0.25pF, 50V, COG, 0603	C11-C12, C17-C18	Murata Electronics	GRM1885C1H1R0CZ01D
CAP, 68pF, 5%, 50V, COG, 0603	C10, C13	Murata Electronics	GRM1885C1H680JA01D
CAP, 680pF, 10%, 50V, X7R, 0603	C1-C2, C5-C6	Murata Electronics	GRM188R71H681KA01D
CAP, 1000pF, 10%, 50V, X7R, 0603	C9, C14	Murata Electronics	GRM188R71H102KA01D
CAP, 10000pF, 10%, 50V, X7R, 0603	C8, C15	Murata Electronics	GRM188R71H103KA01D
CAP, 1µF, 10%, 10V, X5R, 0603	C7, C16	Murata Electronics	GRM188R61A105KA61D
RES, 0Ω, 0402	R3	Panasonic	ERJ-2GE0R00
RES, 412Ω, 1%, 1/16W, 0402	R1-R2	Panasonic	ERJ-2RK4120X
IND, 390nH, 5%, W/W, 1008	L1-L2	Coilcraft	1008CS-391XJBC
TRANSFORMER, S03, 5MHz to 1000MHz, 1:1, UNBAL	T1-T2	MiniRF	XFM-1002-1UH
CONN, HDR, ST, 1-PIN, 0.100"	JP1-JP4	Sullins	PEC01SAAN
CONN, F, EDGE MOUNT, 30 MIL	J1-J2	Trompeter	CBJE130-2
HEATSINK BLOCK, 1.5 X 2.0 IN			
SCREW, 2-56 x 3/16", SOCKET HEAD		McMaster-Carr Supply Co.	92196A076

Evaluation Board Assembly Drawing
(17dB, 50MHz to 1000MHz Application Circuit)

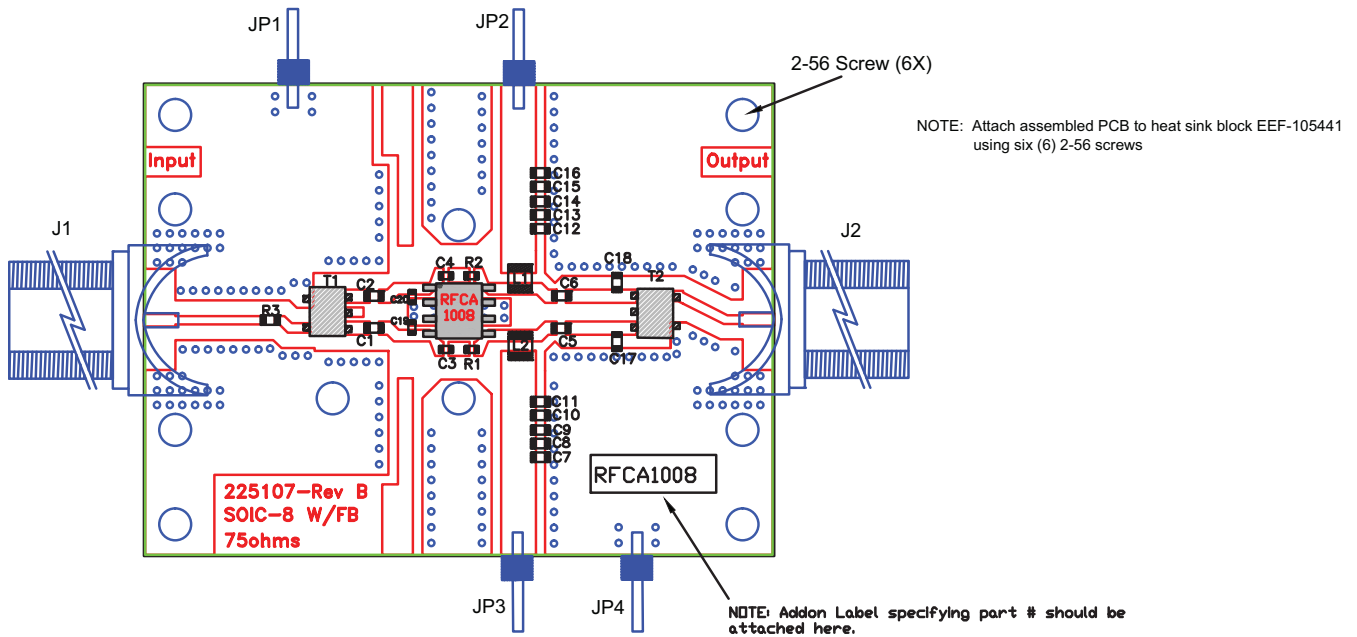

Performance 15dB Application Circuit $V_{CC} = 5V$, $I_{CC} = 150mA$

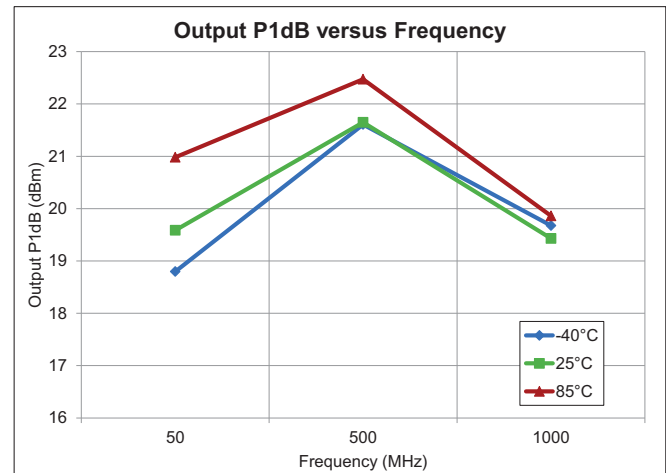
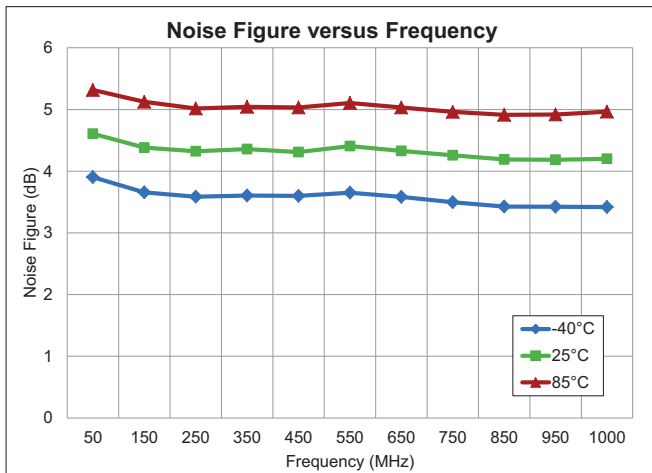
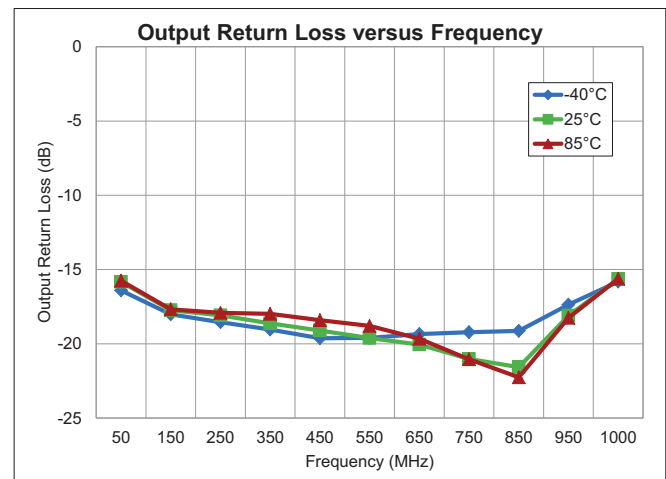
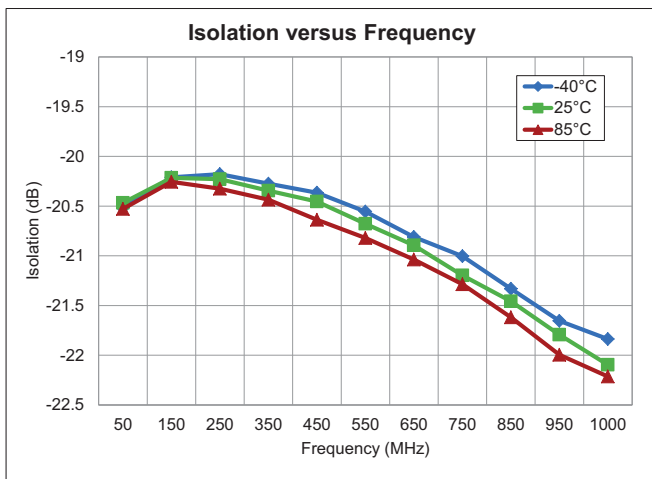
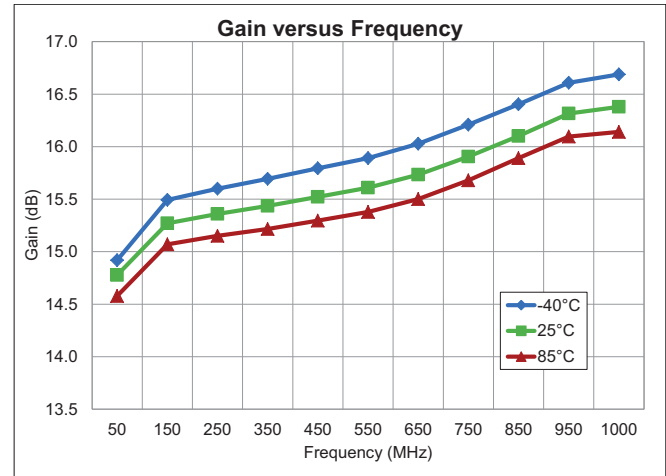
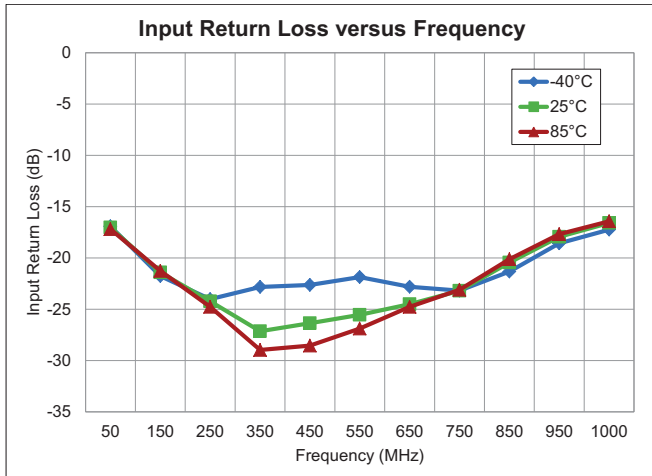

Performance 15dB Application Circuit $V_{CC} = 5V, I_{CC} = 150mA$

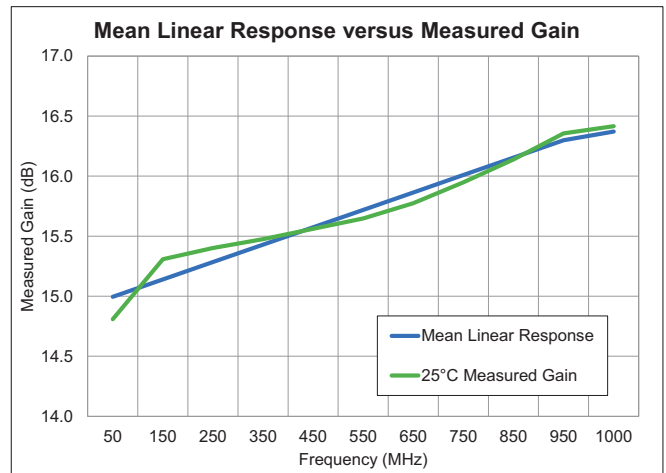
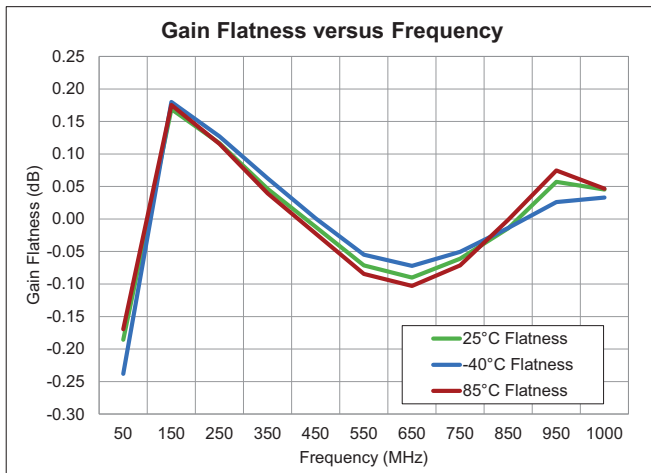
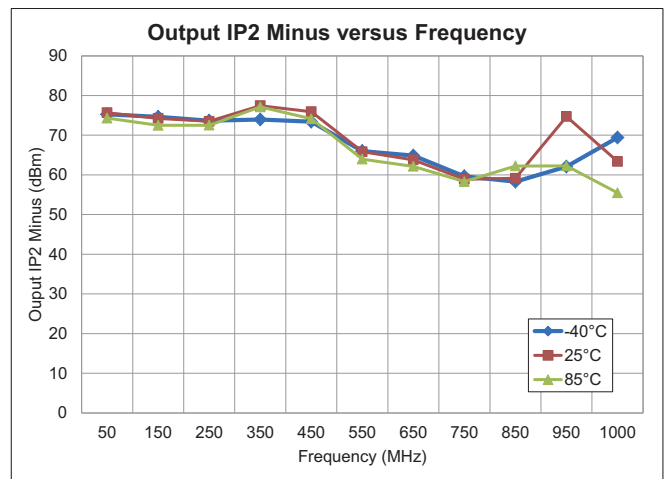
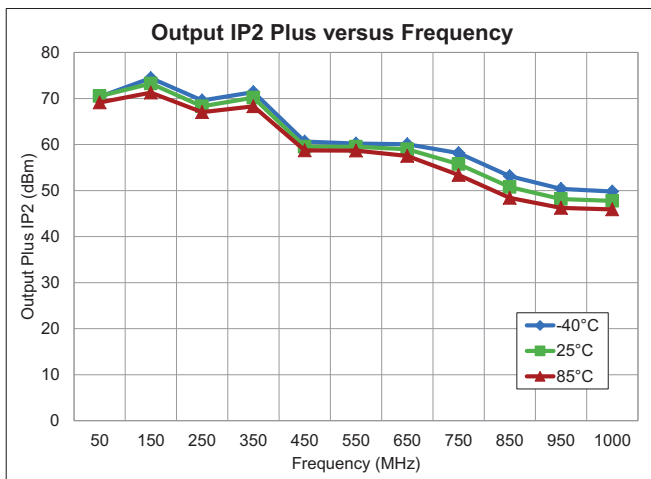
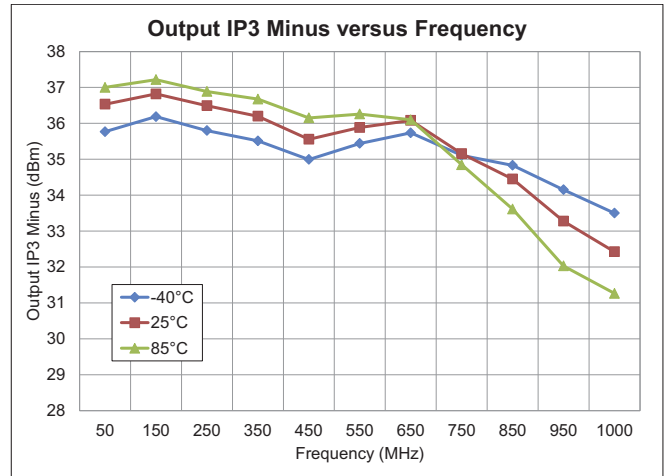
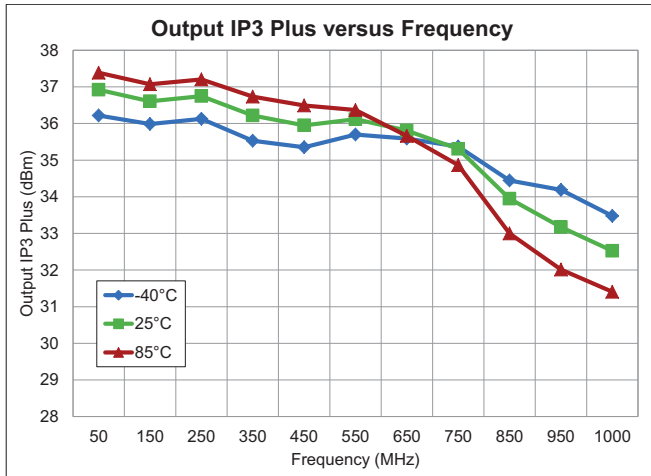

Performance 15dB Application Circuit $V_{CC} = 5V$, $I_{CC} = 150mA$

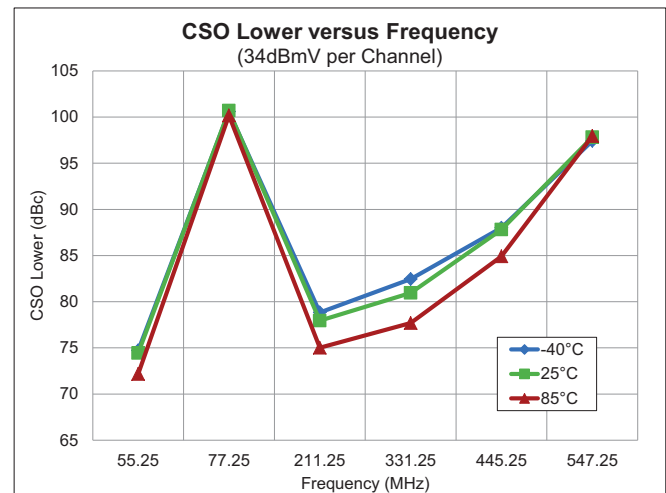
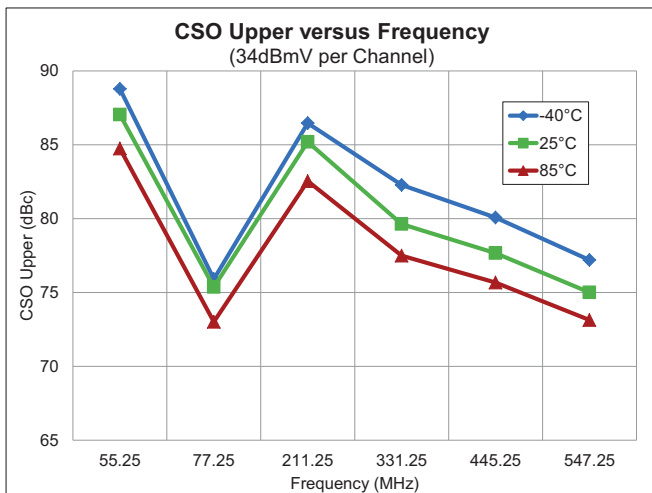
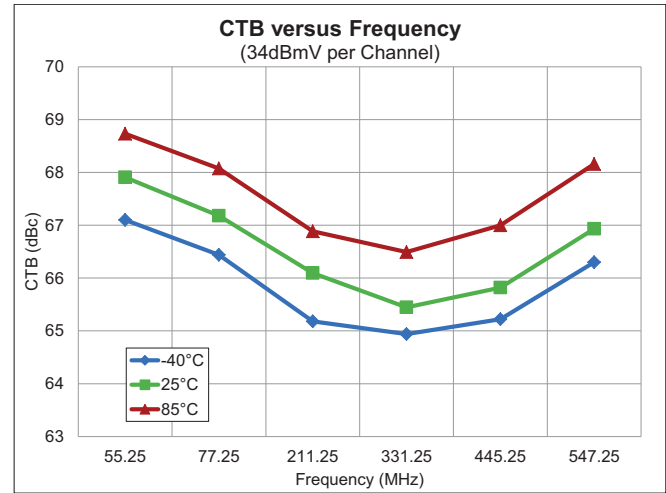
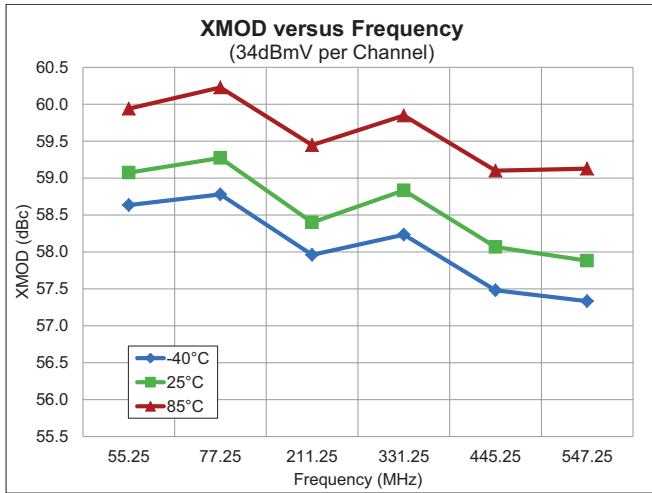

Evaluation Board Schematic
(15dB, 50MHz to 1000MHz Application Circuit)

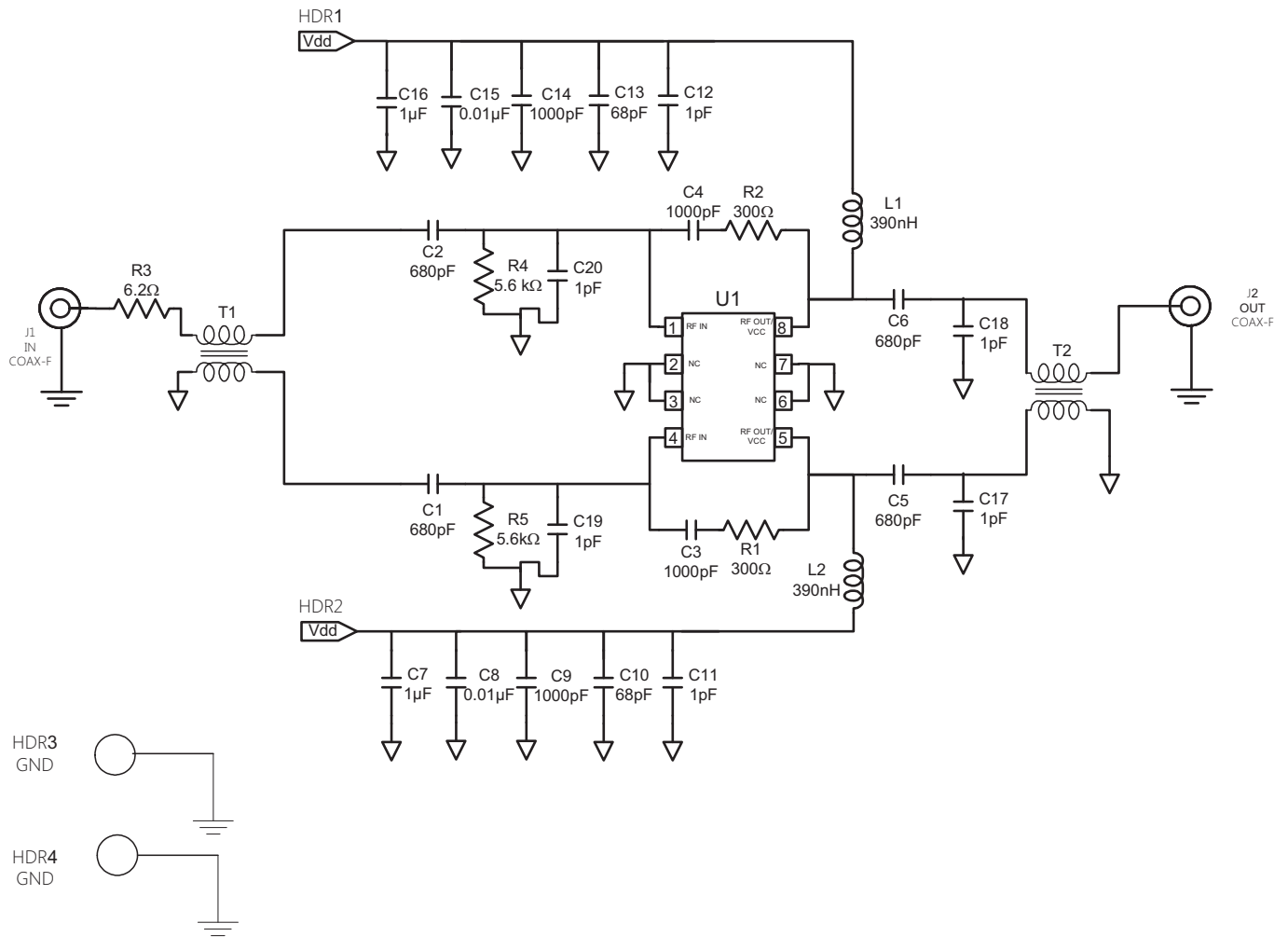

Evaluation Board Bill of Materials (BOM) (15dB, 50MHz to 1000MHz Application Circuit)

Description	Reference Designator	Manufacturer	Manufacturer's P/N
PCB, DEMO, 31 MIL BALANCED SOIC-8 CATV GA		RFMD	225107(B)
CONN, HDR, ST, 1-PIN, 0.100"	JP1-JP4	Sullins Electronics Corp.	PEC01SAAN
CONN, F, EDGE MOUNT, 30 MIL	J1-J2	Trompeter Electronics, Inc.	CBJE130-2
IND, 390nH, 5%, W/W, 1008	L1-L2	Coilcraft	1008CS-391XJBC
CAP, 0.010μF, 10%, 50V, X7R, 0603	C8, C15	Johanson Dielectrics	500R14W103KV4
CAP, 1pF, +/-0.25pF, 50V, C0G, 0603	C11-C12, C17-C18	Murata Electronics	GRM1885C1H1R0CZ01D
CAP, 1pF, +/-0.25pF, 50V, C0G, 0402	C19-C20	Murata Electronics	GRM1555C1H1R0CZ01E
CAP, 1000pF, 10%, 50V, X7R, 0402	C3-C4	Murata Electronics	GRM155R71H102KA01E
CAP, 1000pF, 10%, 50V, X7R, 0603	C9, C14	Murata Electronics	GRM188R71H102KA01D
CAP, 1μF, 10%, 25V, X5R, 0603	C7, C16	Taiyo Yuden (USA), Inc.	RM TMK107BJ105KA-T
CAP, 68pF, 5%, 50V, C0G, 0603	C10, C13	Murata Electronics	GRM1885C1H680JA01D
CAP, 680pF, 10%, 50V, X7R, 0603	C1-C2, C5-C6	Murata Electronics	GRM188R71H681KA01D
RES, 6.2Ω, 5%, 1/16W, 0603	R3	Panasonic Industrial Co	ERJ-3GEYJ6R2V
RES, 300Ω, 5%, 1/16W, 0402	R1-R2	Panasonic Industrial Co	ERJ-2GEJ301
RES, 5.6K, 5%, 1/16W, 0603	R4-R5	Panasonic Industrial Co	ERJ-3GEYJ562
TRANSFORMER, S03, 5MHz to 1000MHz, 1:1, UNBAL	T1-T2	MiniRF	XFM-1002-1UH
DUAL CATV 5MHZ to 1000MHZ HI LIN GaAs HBT	U1	RFMD	RFCA1008
HEATSINK BLOCK, 1.5 x 2.0 IN			EEF-106820(B)
SCREW, 2-56 x 3/16", SOCKET HEAD		McMaster-Carr Supply Co.	92196A076

Evaluation Board Assembly Drawing
(15dB, 50MHz to 1000MHz Application Circuit)

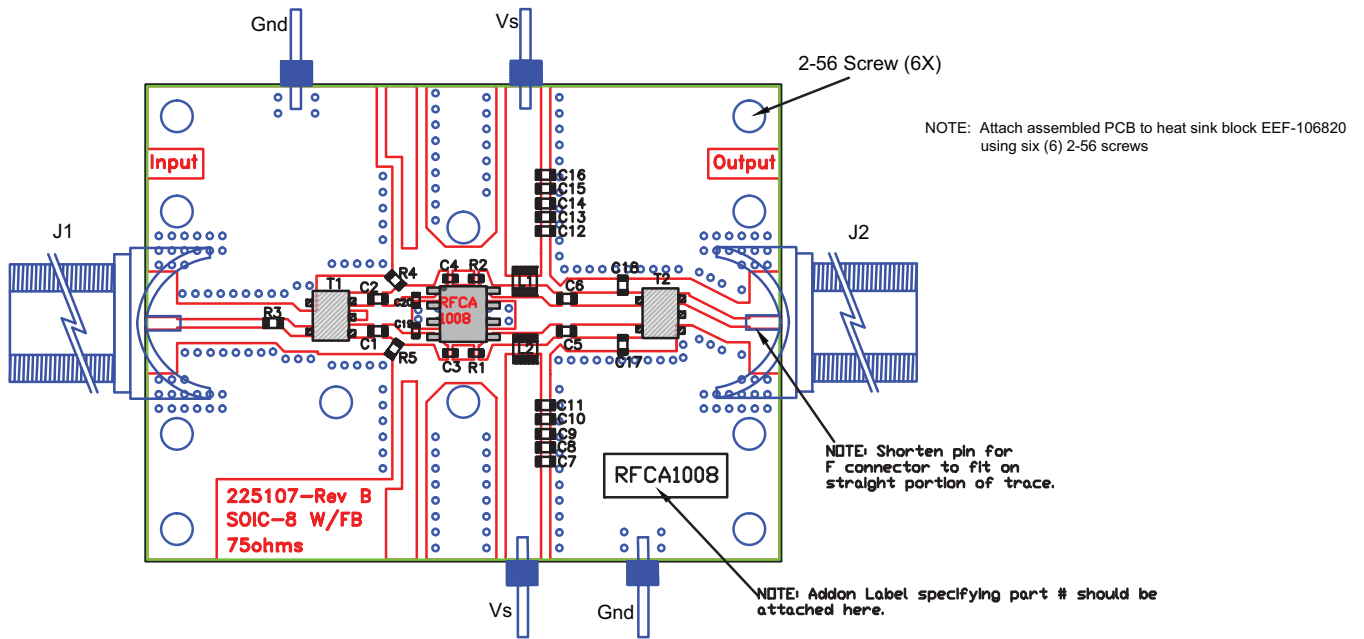

Performance 17dB Return Path $V_{CC} = 5V, I_{CC} = 215mA$

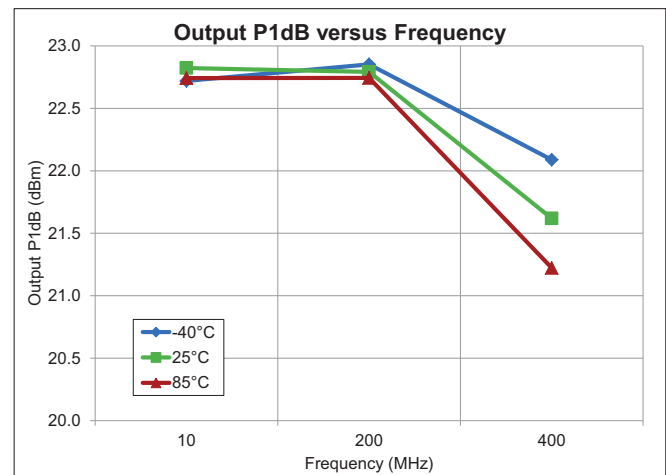
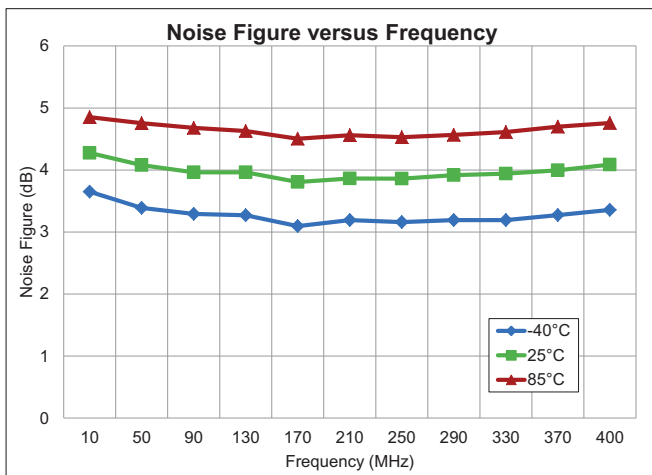
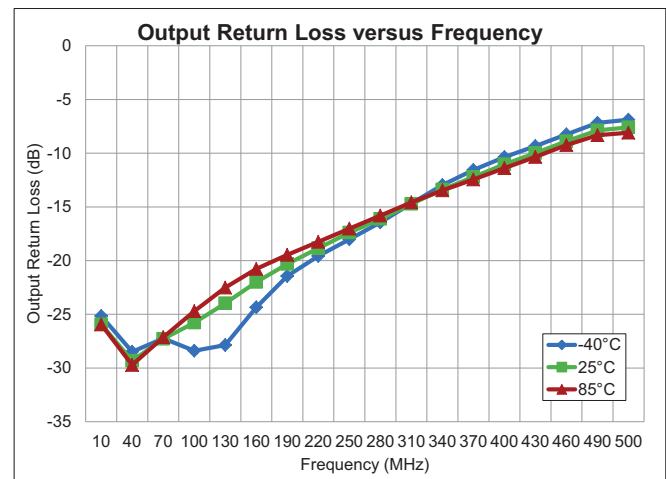
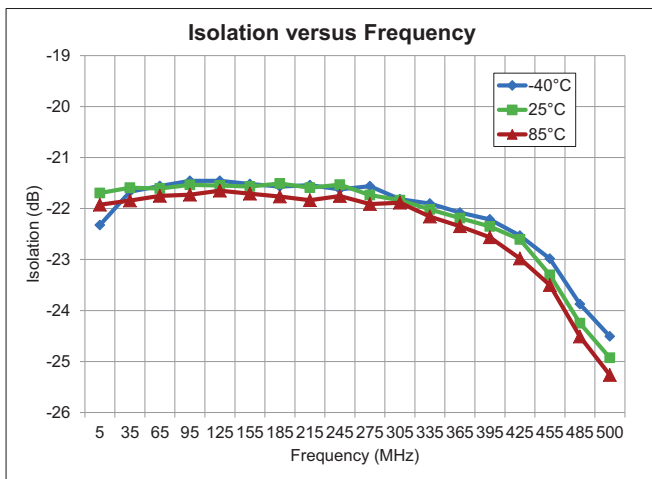
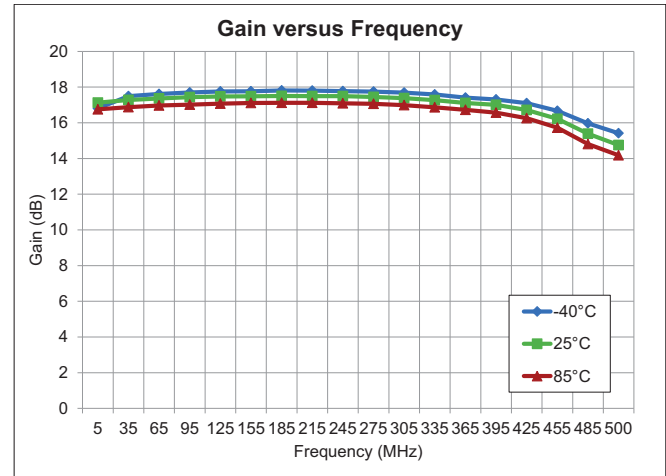
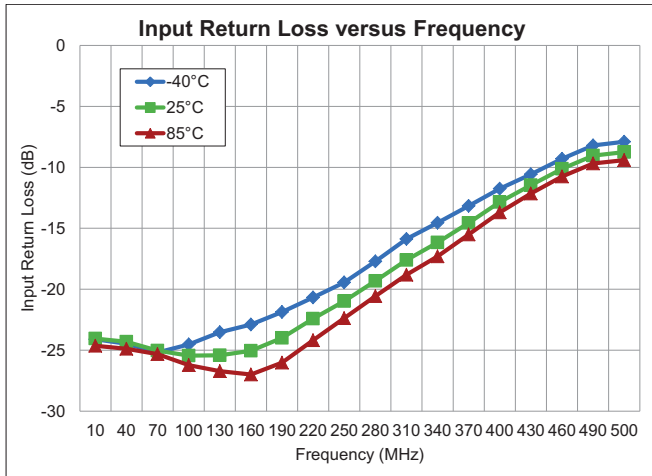

Performance 17dB Return Path $V_{CC} = 5V, I_{CC} = 215mA$

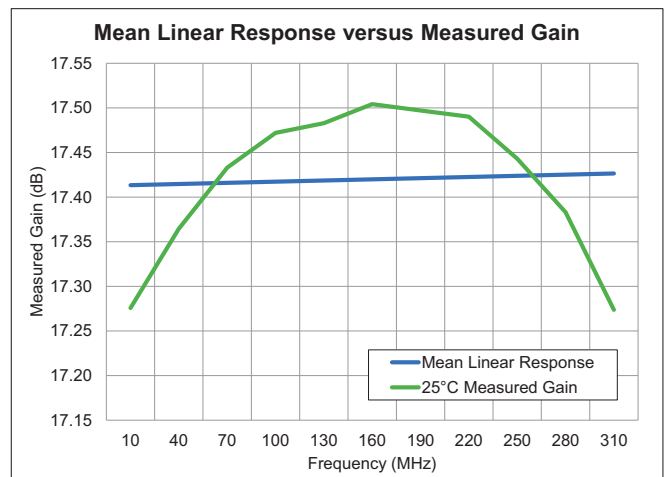
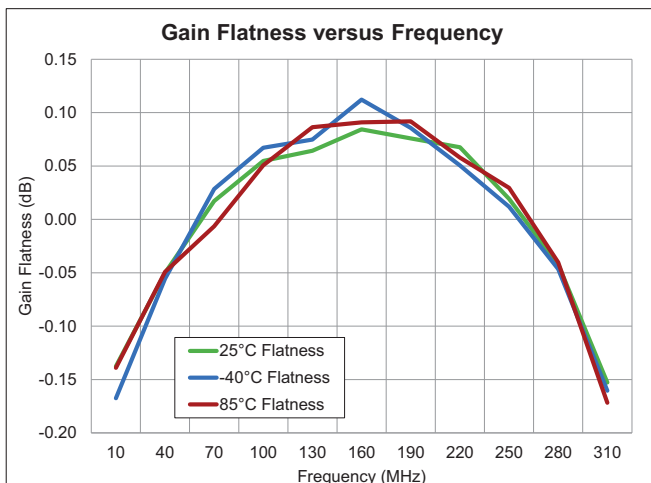
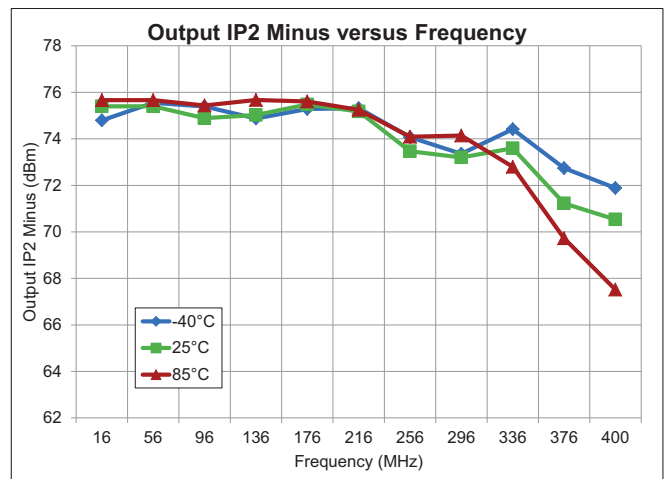
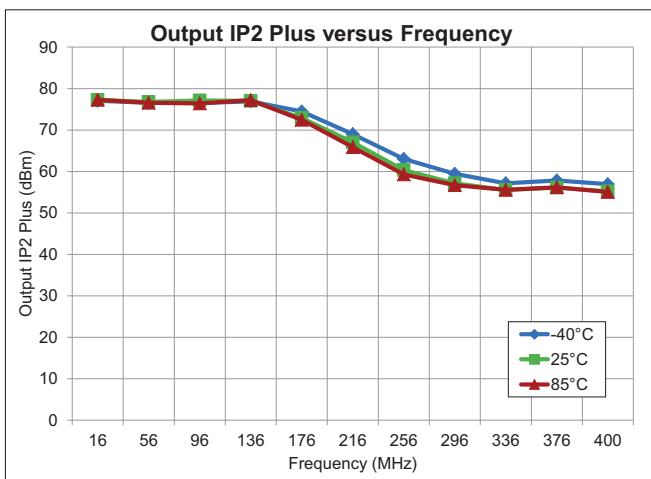
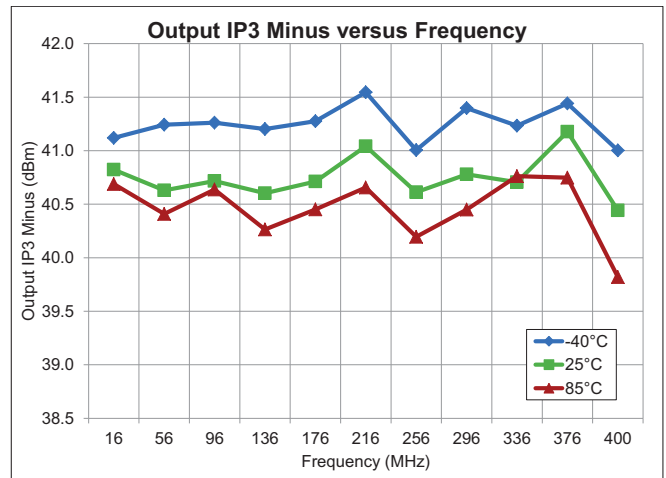
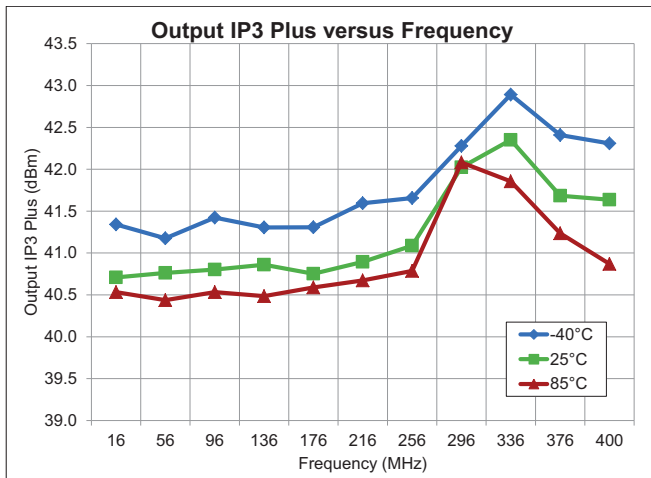

Performance 17dB Return Path $V_{CC} = 5V, I_{CC} = 215mA$

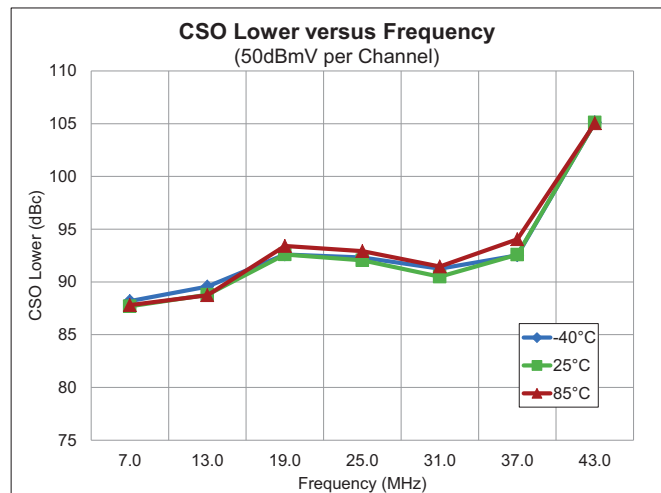
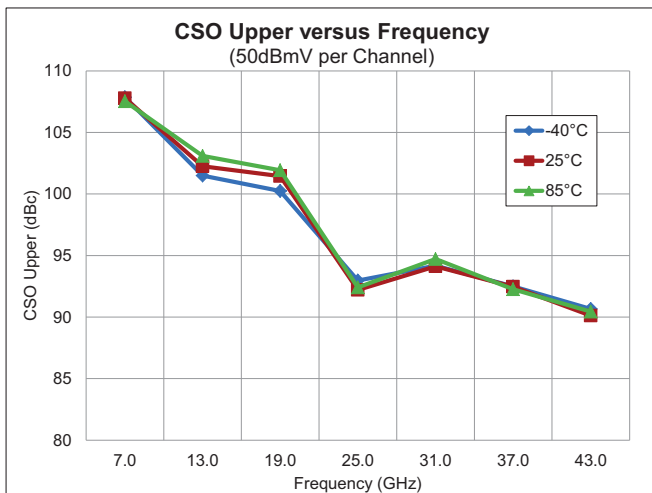
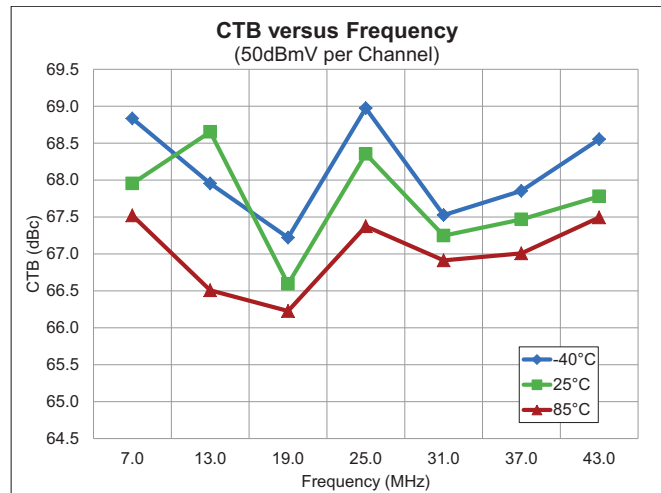
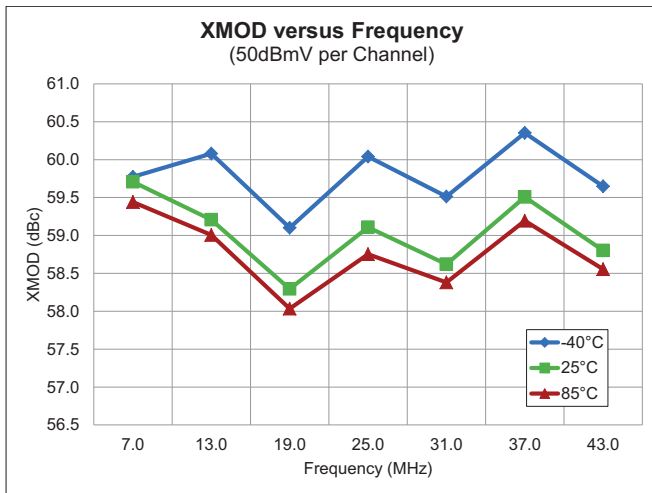

Evaluation Board Schematic
(17dB, 5MHz to 300MHz Application Circuit)

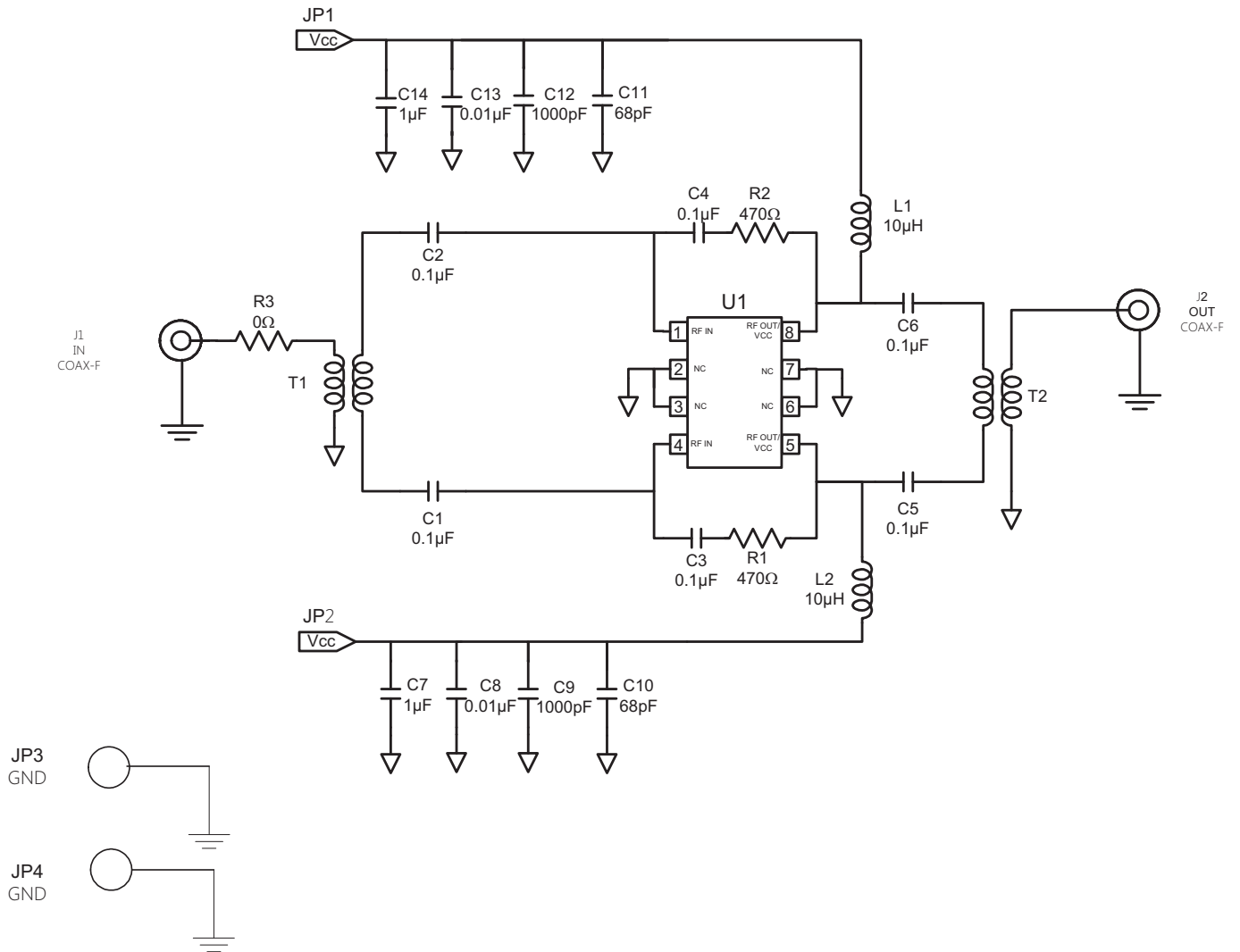

Evaluation Board Bill of Materials (BOM) (17dB, 5MHz to 300MHz Application Circuit)

Description	Reference Designator	Manufacturer	Manufacturer's P/N
PCB, DEMO, 31 MIL BALANCED SOIC-8 CATV GA		RFMD	225107(B)
DUAL CATV 5MHz to 1000MHZ HI LIN GaAs HBT	U1	RFMD	RFCA1008
CAP, 0.1µF, 10%, 25V, X7R, 0603	C1-C2, C5-C6	Kemet	C0603C104K3RAC
CAP, 0.1µF, 10%, 16V, X7R, 0402	C3-C4	Murata Electronics	GRM155R71C104KA88D
CAP, 1µF, 10%, 25V, X5R, 0603	C7, C14	Taiyo Yuden (USA), Inc.	RM TMK107BJ105KA-T
CAP, 68pF, 5%, 50V, C0G, 0603	C10-C11	Murata Electronics	GRM1885C1H680JA01D
CAP, 10000pF, 10%, 50V, X7R, 0603	C8, C13	Murata Electronics	GRM188R71H103KA01D
CAP, 1000pF, 10%, 50V, X7R, 0603	C9, C12	Murata Electronics	GRM188R71H102KA01D
RES, 0Ω, 0603	R3	Panasonic Industrial Co.	ERJ-3GEY0R00V
RES, 470Ω, 5%, 1/16W, 0402	R1-R2	Panasonic Industrial Co.	ERJ-2GEJ471
IND, 10µH, 10%, W/W, 1008	L1-L2	Coilcraft	1008LS-103XJLC
CONN, F, EDGE MOUNT, 30 MIL	J1-J2	Trompeter Electronics, Inc.	CBJE130-2
CONN, HDR, ST, 1-PIN, 0.100"	JP1-JP4	Sullins Electronics Corp.	PBC01SAAN
TRANSFORMER, S03, 1:1, UNBAL	T1-T2	MiniRF	XFM-0201-1WH
HEATSINK BLOCK, 1.5 x 2.0 IN			EEF-106820(B)
SCREW, 2-56 x 3/16", SOCKET HEAD		McMaster-Carr Supply Co.	92196A076

Pin Names and Descriptions

Pin	Name	Description
1	RFIN	RF input pin. External DC-blocking capacitor is required.
2	GND	Connection to ground. Use via holes for best performance to reduce lead inductance as close to ground leads as possible.
3	GND	Connection to ground. Use via holes for best performance to reduce lead inductance as close to ground leads as possible.
4	RFIN	RF input pin. External DC-blocking capacitor is required.
5	RFOUT/VCC	RF output and bias pin (open collector).
6	GND	Connection to ground. Use via holes for best performance to reduce lead inductance as close to ground leads as possible.
7	GND	Connection to ground. Use via holes for best performance to reduce lead inductance as close to ground leads as possible.
8	RFOUT/VCC	RF output and bias pin (open collector).
EPAD	GND	Exposed area on the bottom side of the package must be soldered to the ground plane of the board for optimum thermal and RF performance. Several vias should be located under the EPAD as shown in the recommended land pattern.

Suggested Pad Layout

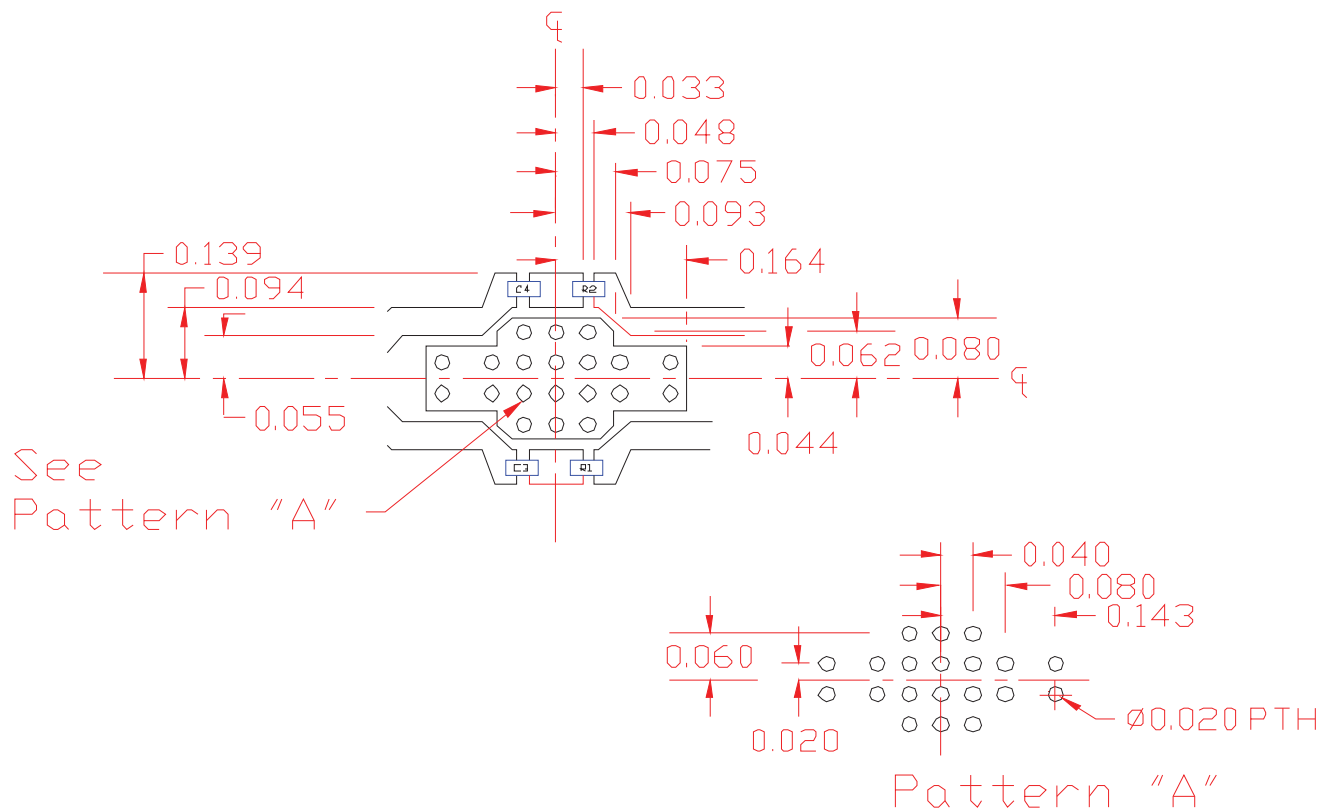

Package Drawing

Dimensions in millimeters

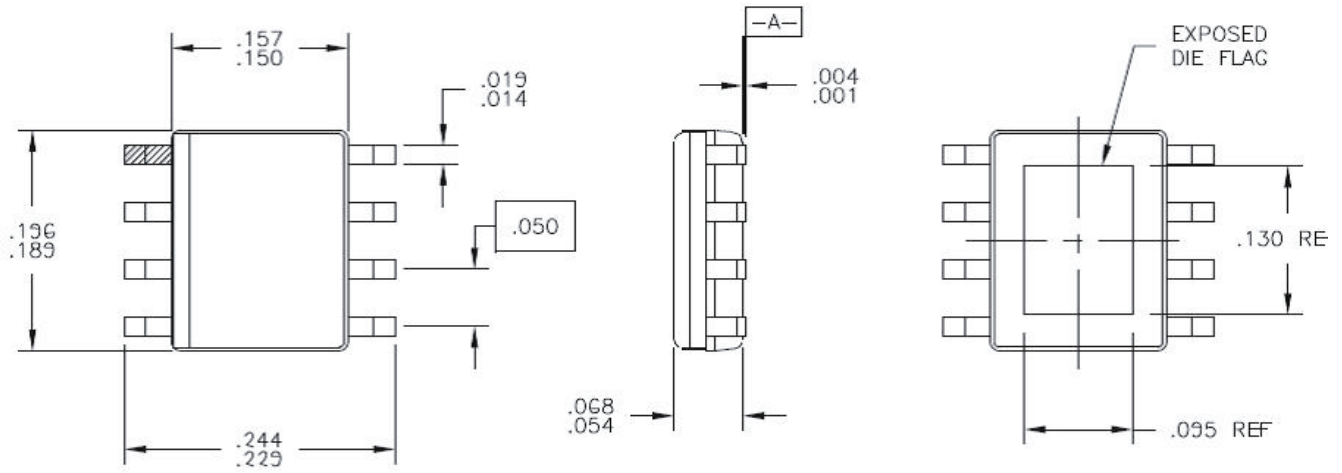

NOTES:

1. SHADED LEAD IS PIN 1.
2. LEAD COPLANARITY: $.003$ WITH RESPECT TO DATUM 'A'.
3. DIMENSIONS DO NOT INCLUDE MOLD FLASH OR PROTRUSIONS.

