

### Product Overview

The RFFC2071A and RFFC2072A are re-configurable frequency conversion devices with integrated fractional-N phased locked loop (PLL) synthesizer, voltage controlled oscillator (VCO) and either one or two high linearity mixers. The fractional-N synthesizer takes advantage of an advanced sigma-delta modulator that delivers ultra-fine step sizes and low spurious products. The VCO features temperature compensation circuits that deliver stable performance across the operating temperature range of -40 °C to +85 °C. The PLL/VCO engine combined with an external loop filter allows the user to generate local oscillator (LO) signals from 85 MHz to 2700 MHz. The LO signal is buffered and routed to the integrated RF mixers which are used to up/down-convert frequencies ranging from 30 MHz to 2700 MHz. The mixer bias current is programmable and can be reduced for applications requiring lower power consumption. Both devices can be configured to work as signal sources by bypassing the integrated mixers. Device programming is achieved via a simple 3-wire serial interface. In addition, a unique programming mode allows up to four devices to be controlled from a common serial bus. This eliminates the need for separate chip-select control lines between each device and the host controller. Up to six general purpose outputs are provided, which can be used to access internal signals (the LOCK signal, for example) or to control front end components. Both devices operate with a 2.7 V to 3.3 V power supply.



Package: QFN, 32-Pin, 5mm x 5mm

### Key Features

- 85 MHz to 4200 MHz LO Frequency Range
- Fractional-N Synthesizer with Very Low Spurious Levels
- Typical Step Size 1.5 Hz
- Fully Integrated Low Phase Noise VCO and LO Buffers
- Integrated Phase Noise
  - 0.18° rms at 1 GHz
- High Linearity RF Mixer(s)
- 30 MHz to 2700 MHz Mixer Frequency Range
- Input IP3 +23 dBm
- Mixer Bias Adjustable for Low Power Operation
- Full Duplex Mode (RFFC2071A)
- 2.7 V to 3.3 V Power Supply
- Low Current Consumption
- 3- or 4-Wire Serial Interface

### Applications

- CATV Head-Ends
- Digital TV Repeaters
- Multi-Dwelling Units
- Diversity Receivers
- Software Defined Radios
- Frequency Band Shifters
- Point-to-Point Radios
- Cellular Repeaters; Cellular Jammers
- WiMax/LTE Infrastructure
- Satellite Communications
- VHF/UHF Radios

### Functional Block Diagram

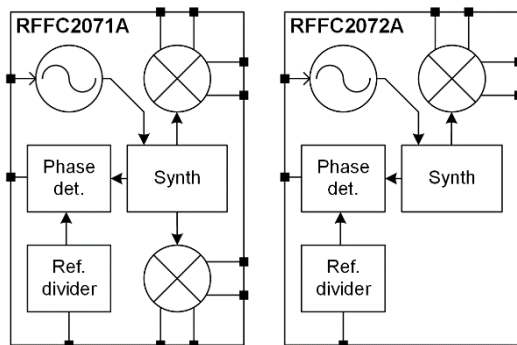

Functional Block Diagram – Simplified

### Ordering Information

Part No.	Description
RFFC2071ATR13	2,500 Pieces on a 13" reel
DKFC2071A	Complete Design Kit in a box
RFFC2072ATR13	2,500 Pieces on a 13" reel
DKFC2072A	Complete Design Kit in a box

## Absolute Maximum Ratings

Parameter	Rating
Storage Temperature	-65 °C to +150 °C
Supply Voltage (VDD)	-0.5 V to +3.6 V
Input Voltage (V <sub>IN</sub> ) on any pin	-0.3 V to VDD +0.3 V
RF/IF Mixer Input Power	+15 dBm

Exceeding any one or a combination of the Absolute Maximum Rating conditions may cause permanent damage to the device. Extended application of Absolute Maximum Rating conditions to the device may reduce device reliability.

## Recommended Operating Conditions

Parameter	Min	Typ	Max	Units
Device Voltage (VDD)	+2.7	+3.0	+3.3	V
T <sub>CASE</sub> (Bottom GND Paddle)	-40		+85	°C
Junction Temperature (T <sub>J</sub> )			+125	°C

Electrical specifications are measured at specified test conditions. Specifications are not guaranteed over all recommended operating conditions.

## Electrical Specifications

Parameter	Condition	Min	Typ.	Max	Units
<b>Logic Inputs/Outputs (VDD = Supply to DIG_VDD pin)</b>					
Input Low Voltage		-0.3		+0.5	V
Input High Voltage		VDD / 1.5		VDD	V
Input Low Current	Input = 0 V	-10		+10	μA
Input High Current	Input = VDD	-10		+10	μA
Output Low Voltage		0		0.2*VDD	V
Output High Voltage		0.8*VDD		VDD	V
Load Resistance		10			kΩ
Load Capacitance				20	pF
<b>GPO Drive Capability</b>					
Sink Current	At V <sub>OL</sub> = +0.6 V		20		mA
Source Current	At V <sub>OH</sub> = +2.4 V		20		mA
Output Impedance			25		Ω
<b>Static States</b>					
Supply Current (IDD) with 1 GHz LO	Low current, MIX_IDD = 1, one mixer enabled		106		mA
	High linearity, MIX_IDD = 6, one mixer enabled		132		mA
Standby	Reference oscillator and bandgap only			2	mA
Power Down Current	ENBL = 0 and REF_STBY = 0			300	μA
<b>Module Thermal</b>					
Thermal Resistance (R <sub>TH</sub> )	Junction to Case (Bottom Exposed Paddle)		32		°C/W
<b>Mixer 1/2 (Mixer output with 4:1 balun)</b>					
Gain	Not including balun losses		-2		dB
Noise Figure	Low current setting		10		dB
	High linearity setting		13		dB
IIP3	Low current setting		+10		dBm
	High linearity setting		+23		dBm
Input Port Frequency Range		30		2700	MHz
Mixer Input Return Loss	100 Ω differential		10		dB
Output Port Frequency Range		30		2700	MHz



## Electrical Specifications

Parameter	Condition	Min	Typ	Max	Units
<b>Frequency Reference</b>					
External Reference Frequency		10		104	MHz
Reference Divider Ratio		1		7	-
External Reference Input Level	AC coupled	500	800	1500	mV <sub>P-P</sub>
<b>Synthesizer (Loop bandwidth of 200 KHz; 52 MHz reference)</b>					
Synthesizer Output Frequency		85		2700	MHz
Phase Detector Frequency				52	MHz
Phase Noise (LO = 1 GHz)	10 kHz offset		-108		dBc/Hz
	100 kHz offset		-107		dBc/Hz
	1 MHz offset		-135		dBc/Hz
	RMS integrated from 1 kHz to 40 MHz		0.18		°
Phase Noise (LO = 2 GHz)	10 kHz offset		-102		dBc/Hz
	100 kHz offset		-101		dBc/Hz
	1 MHz offset		-130		dBc/Hz
	RMS integrated from 1 kHz to 40 MHz		0.33		°
Normalized Phase Noise Floor	Measured at 20 kHz to 30 kHz offset		-214		dBc/Hz
<b>Voltage Controlled Oscillator</b>					
Open Loop Phase Noise at 1 MHz offset					
2.5 GHz LO Frequency	VCO3		-133		dBc/Hz
2.0 GHz LO Frequency	VCO2		-134		dBc/Hz
1.5 GHz LO Frequency	VCO1		-136		dBc/Hz
Open Loop Phase Noise at 10 MHz offset					
2.5 GHz LO Frequency	VCO3		-149		dBc/Hz
2.0 GHz LO Frequency	VCO2		-150		dBc/Hz
1.5 GHz LO Frequency	VCO1		-151		dBc/Hz
<b>External LO Input</b>					
LO Input Frequency Range	LO Divide by 2	85		5400	MHz
External LO Input Level	Driven from 50Ω Source via a 1:1 Balun		0		dBm

## Theory of Operation

---

The RFFC2071A and RFFC2072A are wideband RF frequency converter chips which include a fractional-N synthesizer and a low noise VCO core. The RFFC2071A has an LO signal multiplexer, two LO buffer circuits, and two RF mixers. The RFFC2072A has a single LO buffer circuit and one RF mixer. Both devices have an integrated voltage reference and low drop out regulators supplying critical circuit blocks such as the VCOs and synthesizer. Synthesizer programming, device configuration and control are achieved through a mixture of hardware and software controls. All on-chip registers are programmed through a simple 3-wire serial interface.

### VCO

The VCO core in the RFFC2071A and RFFC2072A consists of three VCOs which, in conjunction with the integrated LO dividers of  $/2$  to  $/32$ , cover the LO range of 85MHz to 2700 MHz. Each VCO has 128 overlapping bands which are used to achieve low VCO gain and optimal phase noise performance across the whole tuning range. The chip automatically selects the correct VCO (VCO auto-select) and VCO band (VCO coarse tuning) to generate the desired LO frequency based on the values programmed into the PLL1 and PLL2 registers banks.

The VCO auto select and VCO coarse tuning are triggered every time ENBL is taken high, or if the PLL re-lock self-clearing bit is programmed high. Once the correct VCO and band have been selected the PLL will lock onto the correct frequency. During the band selection process, fixed capacitance elements are progressively connected to the VCO resonant circuit until the VCO is oscillating approximately at the correct frequency. The output of this band selection, CT\_CAL, is made available in the readback register. A value of 127 or 0 in this register indicates that the coarse tuning was unsuccessful, and this will also be indicated by the CT\_FAILED flag also available in the read-back register. A CT\_CAL value between 1 and 126 indicates a successful calibration, the actual value being dependent on the desired frequency as well as process variation for a particular device.

The band select process will center the VCO tuning voltage at about 0.8 V, compensating for manufacturing tolerances and process variation as well as environmental factors including temperature. The VCOs have temperature compensation circuits so the PLL will hold lock over the entire operating temperature range of  $-40^{\circ}\text{C}$  to  $+85^{\circ}\text{C}$ . This is true regardless of the temperature at which the VCO band selection is performed. The VCO tuning gain is also held stable across temperature, maintaining consistent loop bandwidth and synthesizer phase noise.

The RFFC2071A and RFFC2072A feature a differential LO input to allow the mixer to be driven from an external LO source. The fractional-N PLL can be used with an external VCO driven into this LO input, which may be useful to reduce phase noise in some applications. This may also require an external op-amp, dependent on the tuning voltage required by the external VCO.

In the RFFC2071A the LO signal is routed to mixer 1, mixer 2, or both mixers depending on the state of the MODE pin (or MODE bit if under software control) and the value of the FULLD bit. Setting FULLD high puts the device into Full Duplex mode and both mixers are enabled.

### Fractional-N PLL

The RFFC2071A and RFFC2072A contain a charge pump-based fractional-N phase locked loop (PLL) for controlling the three VCOs. The PLL includes automatic calibration systems to counteract the effects of process and environmental variations, ensuring repeatable loop response and phase noise performance. As well as the VCO auto select and coarse tuning, there is a loop filter calibration mechanism which can be enabled if required. This operates by adjusting the charge pump current to maintain loop bandwidth. This can be useful for applications where the LO is tuned over a wide frequency range.

The PLL has been designed to use a reference frequency of between 10 MHz and 104 MHz from an external source, which is typically a temperature compensated crystal oscillator (TCXO). A reference divider (divide by 1 to divide by 7) is supplied and should be programmed to limit the frequency at the phase detector to a maximum of 52 MHz.

Two PLL programming banks are provided, the first bank is preceded by the label PLL1, and the second bank is preceded by the label PLL2. For the RFFC2071A these banks are used to program mixer 1 and mixer 2 respectively and are selected automatically as the mixer is selected by using MODE. For the RFFC2072A mixer 2 and register bank PLL2 are normally used.

The VCO outputs are first divided down in a high frequency prescaler. The output of this high frequency prescaler then enters the N divider, which is a fractional divider containing a dual-modulus prescaler and a digitally spur-compensated fractional sequence generator. This allows very fine frequency steps and minimizes fractional spurs. The fractional energy is randomized and appears as fractional noise at frequency offsets above 100 kHz which will be attenuated by the loop filter. An external loop filter is used, giving flexibility in setting loop bandwidth for optimizing phase noise and lock time, for example.

The synthesizer step size is typically 1.5 Hz when using a 26 MHz reference frequency. The exact step size for any reference and LO frequency can be calculated using the following formula:

$$(F_{REF} * P) / (R * 2^{24} * LO\_DIV)$$

Where  $F_{REF}$  is the reference frequency, R is the reference division ratio, P is the prescaler division ratio, and LO\_DIV is the LO divider value.

Pin 26 (GPO4) can be configured as a lock detect pin. The lock status is also available in the read-back register. The lock detect function is a window detector on the VCO tuning voltage. The lock flag will be high to show PLL lock which corresponds to the VCO tuning voltage being within the specified range, typically 0.30 V to 1.25 V.

The lock time of the PLL will depend on a number of factors, including the loop bandwidth and the reference frequency at the phase detector. This clock frequency determines the speed at which the state machine and internal calibrations run. A 52 MHz phase detector frequency will give fastest lock times, of typically <50 μsecs when using the PLL re-lock bit.

### Phase Detector and Charge Pump

The phase detector provides a current output to drive an active loop filter. The charge pump output current is set by the value contained in the P1\_CP\_DEF and P2\_CP\_DEF fields in the loop filter configuration register. The charge pump current is given by approximately 3 μA/bit, and the fields are 6 bits long. This gives default value (31) of 93 μA and maximum value (63) of 189 μA.

If the automatic loop bandwidth calibration is enabled the charge pump current is set by the calibration algorithm based upon the VCO gain.

The phase detector will operate with a maximum input frequency of 52 MHz.

### Loop Filter

The active loop filter is implemented using the on-chip low noise op-amp with external resistors and capacitors. The internal configuration of the chip is shown below with the recommended active loop filter. The op-amp gives a tuning voltage range of typically +0.1 V to +2.4 V. The recommended loop filter shown is designed to give the lowest integrated phase noise for reference frequencies of between 26 MHz and 52 MHz. The external loop filter gives the flexibility to optimize the loop response for any particular application and combination of reference and VCO frequencies.

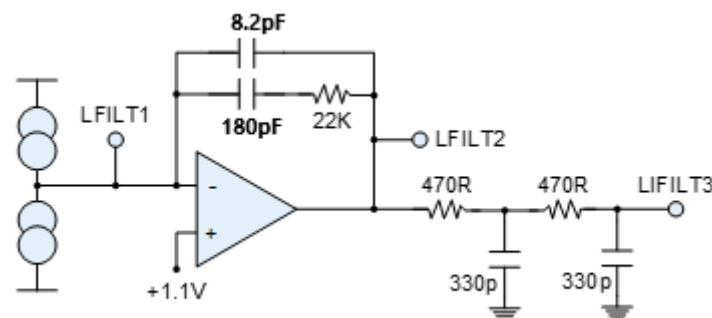

### External Frequency Reference

The RFFC2071A and RFFC2072A have been designed to use an external reference such as a TCXO. The typical input will be a 0.8 V<sub>p-p</sub> clipped sine wave, which should be AC-coupled into the reference input. When the PLL is not in use, it may be desirable to turn off the internal reference circuits, by setting the REFSTBY bit low, to minimize current draw while in standby mode.

On cold start, or if REFSTBY is programmed low, the reference circuits will need a warm-up period. This is set by the SU\_WAIT bits. This will allow the clock to be stable and immediately available when the ENBL bit is asserted high, allowing the PLL to assume normal operation.

If the current consumption of the reference circuits in standby mode, typically 2 mA, is not critical, then the REFSTBY bit can be set high. This allows the fastest startup and lock time after ENBL is taken high.

### Wideband Mixer

The mixers are wideband, double-balanced Gilbert cells. They support RF/IF frequencies from 30 MHz up to 2700 MHz. Each mixer has an input port and an output port that can be used for either IF or RF (in other words, for up- or down-conversion). The mixer current can be programmed to between about 15 mA and 45 mA depending on linearity requirements. The majority of the mixer current is sourced through the output pins via either a center-tapped balun or an RF choke in the external matching circuitry to the supply.

The RF mixer input and output ports are differential and require baluns and simple matching circuits optimized to the specific application frequencies. A conversion gain of approximately -2 dB (not including balun losses) is achieved with 100 Ω differential input impedance, and the outputs driving 200 Ω differential load impedance. Increasing the mixer output load increases the conversion gain.

The mixer has a broadband common gate input. The input impedance is dominated by the resistance set by the mixer 1/gm term, which is inversely proportional to the mixer current setting. The resistance will be approximately 85 Ω at the default mixer current setting (100). There is also some shunt capacitance at the mixer input, and the inductance of the bond wires (about 0.5 nH on each pin) to consider at higher frequencies. The following diagram is a simple model of the mixer input impedance:

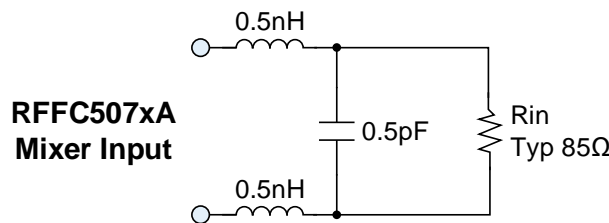

The mixer output is high impedance, consisting of approximately 2 kΩ resistance in parallel with some capacitance, approximately 1 pF. The mixer output does not require a conjugate matching network. It is a constant current output which will drive a real differential load of between 50 Ω and 500 Ω, typically 200 Ω. Since the mixer output is a constant current source, a higher resistance load will obtain higher output voltage and gain. A shunt inductor can be used to resonate with the mixer output capacitance at the frequency of interest. This inductor may not be required at lower frequencies where the impedance of the output capacitance is less significant. At higher output frequencies the inductance of the bond wires (about 0.5 nH on each pin) becomes more significant. The following diagram is a simple model of the mixer output:

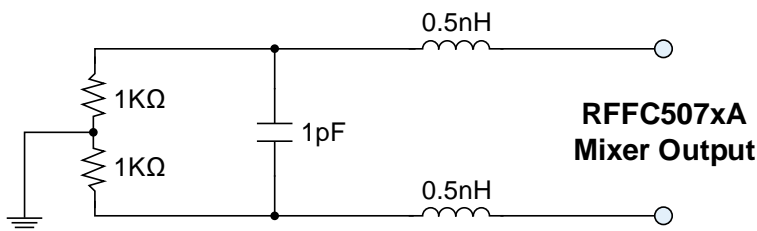

The RFFC2071A mixer layout and pin placement has been optimized for high mixer-to-mixer isolation of greater than 60 dB. The mixers can be set up to operate in half duplex mode (1 mixer active) or full duplex mode (both mixers active). This selection is done via control of MODE and by setting the FULLD bit. When in full duplex mode, either PLL register bank can be used, the LO signal is routed to both mixers.

Mode	FULLD	Active PLL Register Bank	Active Mixer
Low	0	1	1
High	0	2	2
Low	1	1	1 and 2
High	1	2	1 and 2

## Serial Interface

All on-chip registers in the RFFC2071A and RFFC2072A are programmed using a proprietary 3-wire serial bus which supports both write and read operations. Synthesizer programming, device configuration, and control are achieved through a mixture of hardware and software controls. Certain functions and operations require the use of hardware controls via the ENBL, MODE, and RESETX pins in addition to programming via the serial bus. Alternatively, there is the option to control the chip completely via the serial bus

The serial data interface can be configured for 4-wire operation by setting the 4WIRE bit in the SDI\_CTRL register high. Then pin 26 is used as the data out pin, and pin 32 is the serial data in pin.

## Hardware Control

Three hardware control pins are provided: ENBL, MODE, and RESETX.

The ENBL pin has two functions: to enable the analog circuits in the chip and to trigger the VCO auto-selection and coarse tuning mechanisms. The VCO auto-selection and coarse tuning is initiated when the ENBL pin is taken high. Every time the frequency of the synthesizer is reprogrammed, ENBL has to be asserted high to initiate these mechanisms and then to initiate the PLL locking. Alternatively following the programming of a new frequency, the PLL re-lock self-clearing bit could be used.

The RESETX pin is a hardware reset control that will reset all digital circuits to their startup state when asserted low. The device includes a power-on-reset function, so this pin should not normally be required, in which case it should be connected to the positive supply.

The MODE pin controls which mixer(s) and PLL programming register bank is active.

## Serial Data Interface Control

The normal mode of operation uses the 3-wire serial data interface to program the device registers, and three extra hardware control lines: MODE, ENBL and RESETX.

When the device is under software control, achieved by setting the SIPIN bit in the SDI\_CTRL register high, then the hardware can be controlled via the SDI\_CTRL register. When this is the case, the three hardware control lines are not required. If the device is under software control, pins 1 and 9 can be configured as general purpose outputs (GPO).

## Multi-Slice Mode

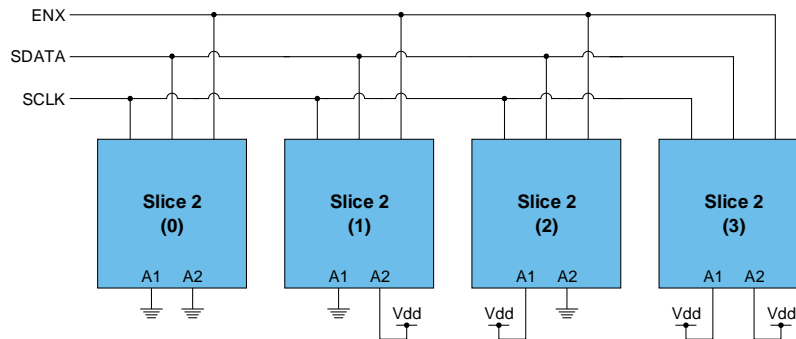

The Multi-Slice mode of operation allows up to four chips to be controlled from a common serial bus. The device address pins (15 and 16) ADD1 and ADD2 are used to set the address of each part.

On power up, and after a reset, the devices ignore the address pins ADD1 and ADD2 and any data presented to the serial bus will be programmed into all the devices. However, once the ADDR bit in the SDI\_CTRL register is set, each device then adopts an address according to the state of the address pins on the device.

## General Purpose Outputs

The general purpose outputs (GPOs) can be controlled via the GPO register and will depend on the state of MODE since they can be set in different states corresponding to either mixer path 1 or 2. For example, the GPOs can be used to drive LEDs or to control external circuitry such as switches or low power LNAs.

Each GPO pin can supply approximately 20 mA load current. The output voltage of the GPO high state will drop with increased current drive by approximately 25 mV/mA. Similarly, the output voltage of the GPO low state will rise with increased current, again by approximately 25 mV/mA.

## External Modulation

The RFFC2071A and RFFC2072A fractional-N synthesizer can be used to modulate the frequency of the VCO. There are two dedicated registers, EXT\_MOD and FMOD, which can be used to configure the device as a modulator. It is possible to modulate the VCO in two ways:

### 1.Binary FSK

The MODSETUP bits in the EXT\_MOD register are set to 11. GPO3 is then configured as an input and used to control the signal frequency. The frequency deviation is set by the MODSTEP and MODULATION bits in the EXT\_MOD and FMOD registers respectively.

The modulation frequency is calculated according to the following formula:

$$F_{MOD} = 2^{MODSTEP} \cdot F_{PD} \cdot (MODULATION) / 2^{16}$$

Where MODULATION is a 2's complement number and  $F_{PD}$  is the phase detector frequency

### 2.Continuous Modulation

The MODSETUP bits in the EXT\_MOD register are set to 01. The frequency deviation is set by the MODSTEP and MODULATION bits in the EXT\_MOD and FMOD registers respectively. The VCO frequency is then changed by writing a new value into the MODULATION bits, the VCO frequency is instantly updated. An arbitrary frequency modulation can then be performed dependent only on the rate at which values are written into the FMOD register.

The modulation frequency is calculated according to the following formula:

$$F_{MOD} = 2^{MODSTEP} \cdot F_{PD} \cdot (MODULATION) / 2^{16}$$

Where MODULATION is a 2's complement number and  $F_{PD}$  is the phase detector frequency.





## **Programming Information**

---

The RFFC2071A and RFFC2072A share a common serial interface and control block. Please refer to the Register Maps and Programming Guide which are available for download from <https://www.qorvo.com/products/d/da000718>.

## **Evaluation Boards**

---

Evaluation boards for RFFC2071A and RFFC2072A are provided as part of a design kit, along with the necessary cables and programming software tool to enable full evaluation of the device. The evaluation board has been configured for wideband operation. The mixer inputs and outputs are connected to wideband baluns. Design kits can be ordered from [www.qorvo.com](http://www.qorvo.com) or from local Qorvo sales offices and authorized sales channels. For ordering codes please see “Ordering Information” on page 1.

For further details on how to set up the design kits go to <https://www.qorvo.com/products/d/da000718>.

Detailed Functional Block Diagram

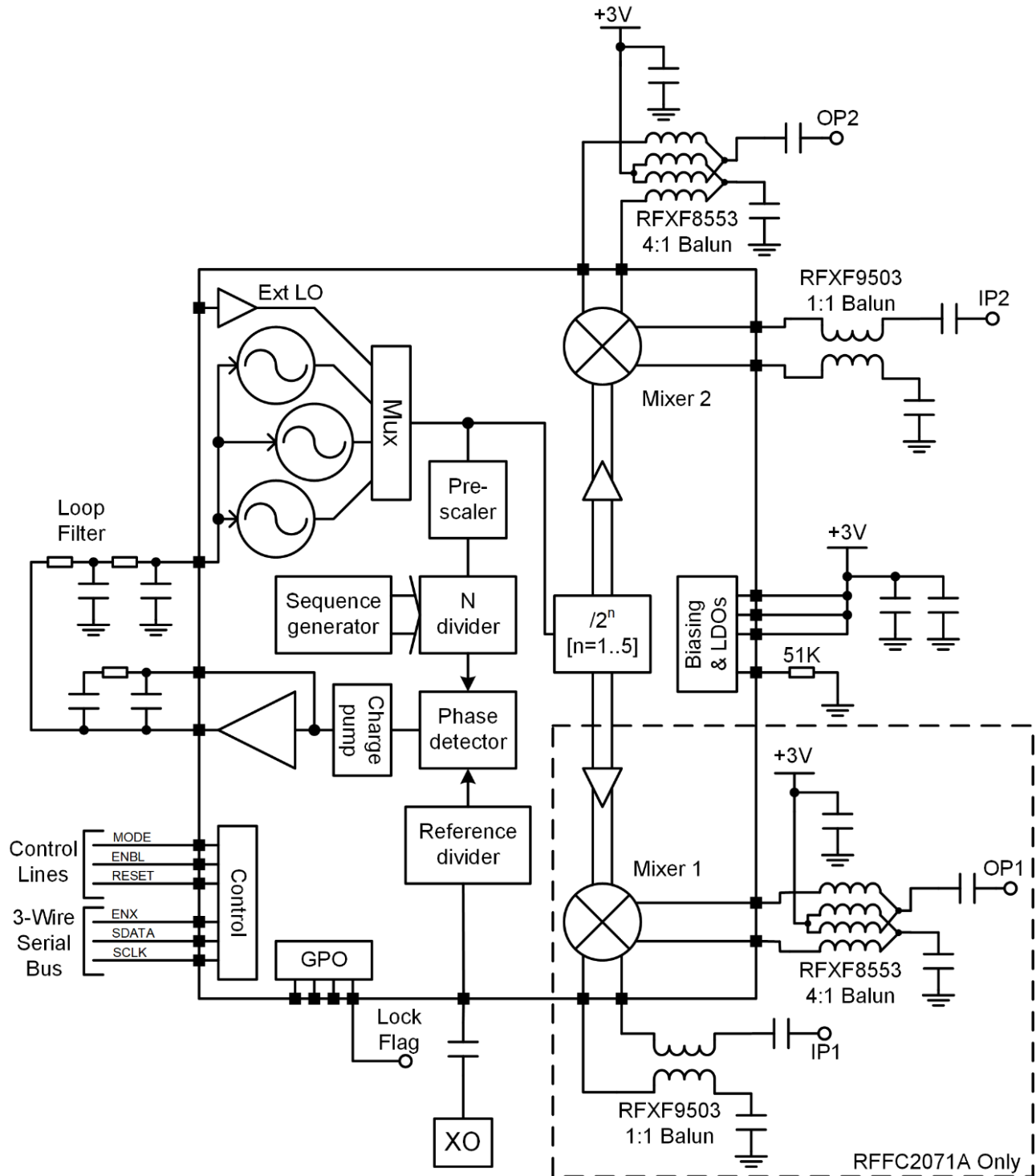

## Application Schematic

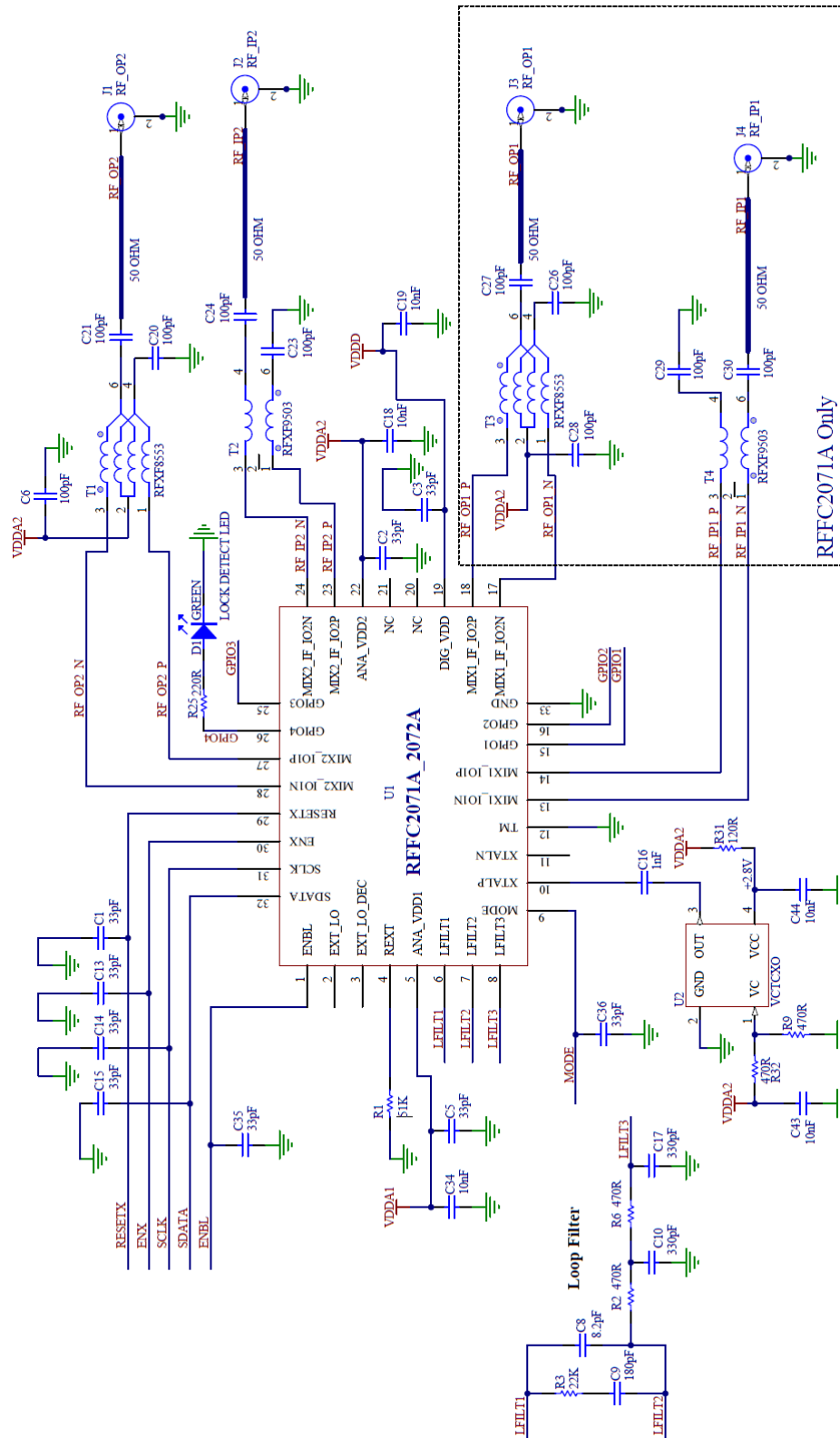

## Typical Synthesizer Performance Characteristics

VDD = +3 V and T<sub>C</sub> = +27 °C unless stated otherwise, on RFFC2071A/RFFC2072A EVB with active loop filter

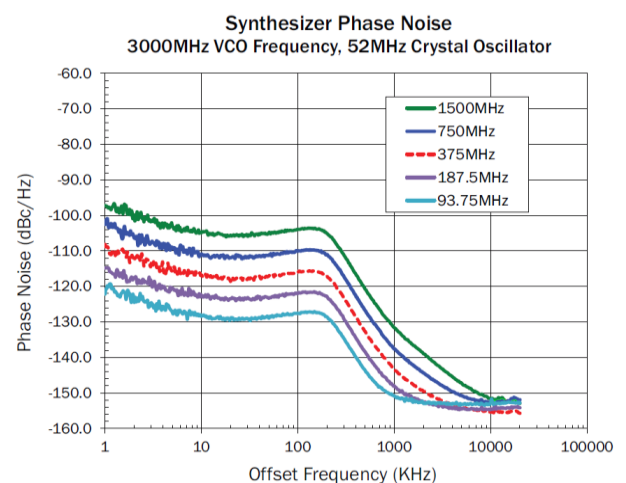
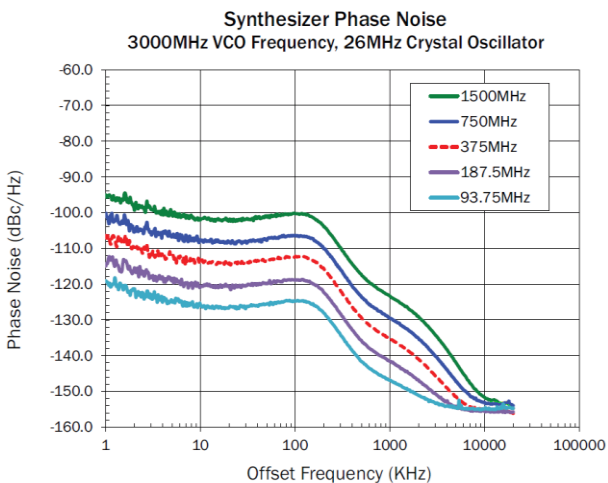
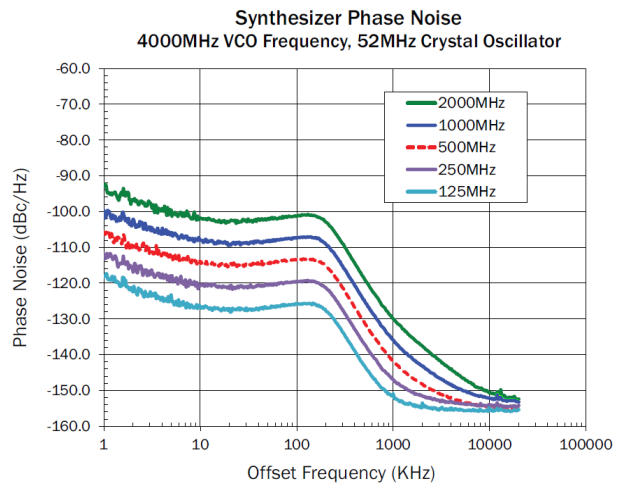
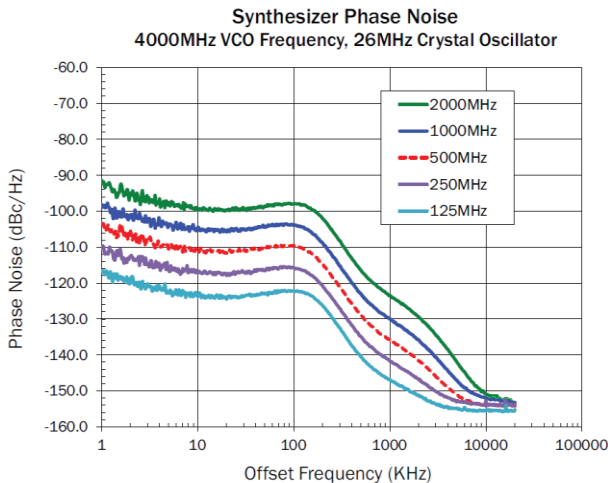
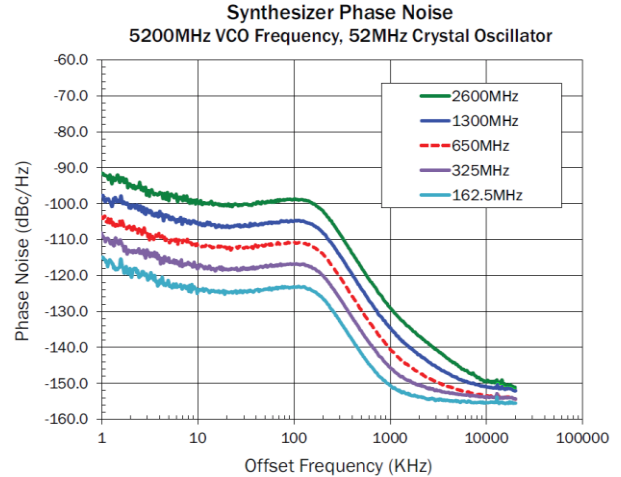
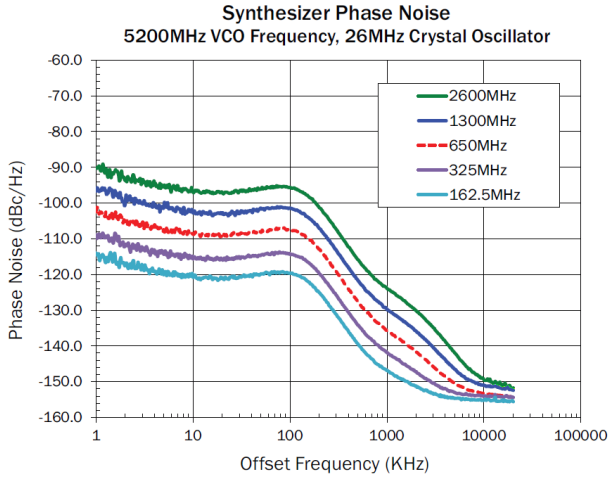

## Typical Synthesizer Performance Characteristics

VDD = +3 V and T<sub>C</sub> = +27 °C unless stated otherwise, on RFFC2071A/RFFC2072A EVB

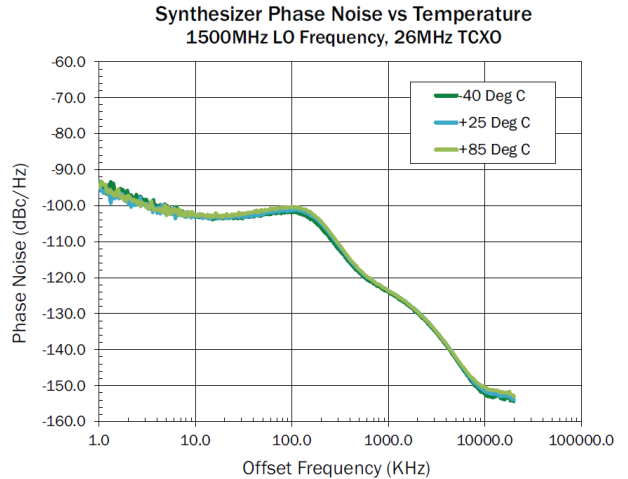
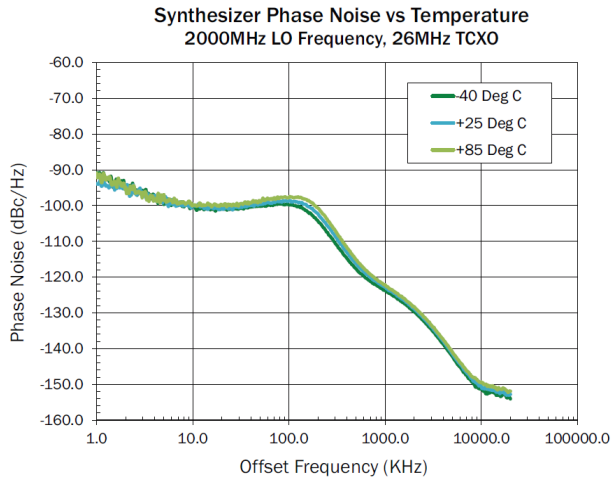
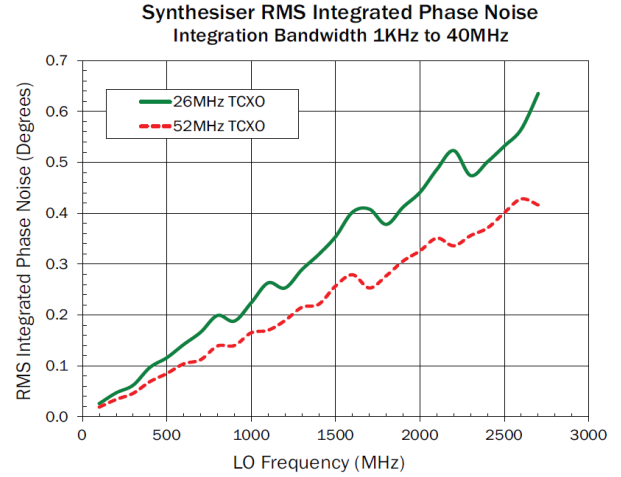
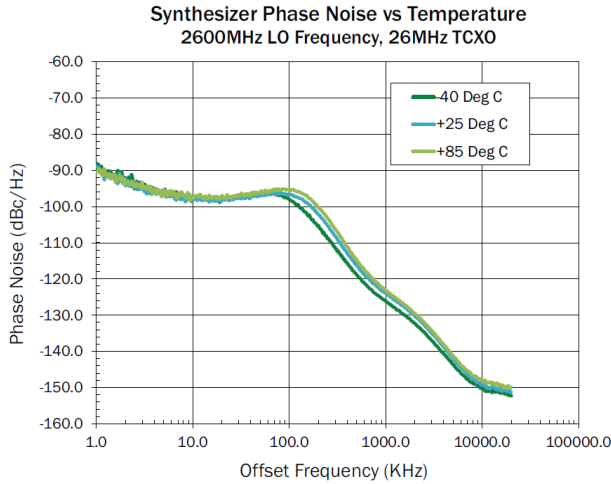

**Notes:**

1. 26 MHz Crystal Oscillator: NDK ENA3523A
2. 52 MHz Crystal Oscillator: NDK ENA3560A

## Typical VCO Performance Characteristics

VDD = +3 V and T<sub>C</sub> = +27 °C unless stated otherwise, on RFFC2071A/RFFC2072A EVB

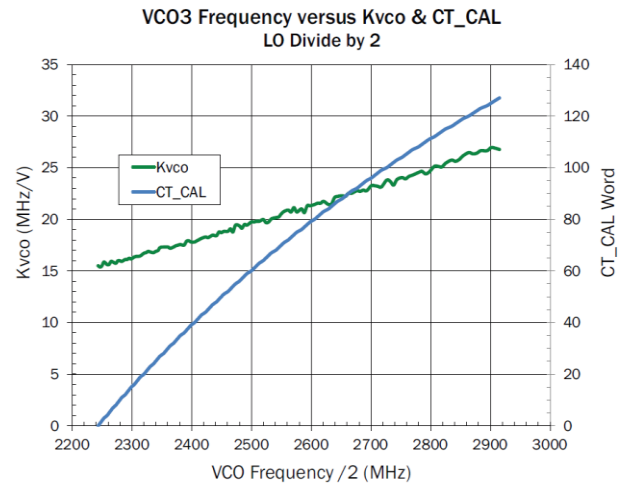
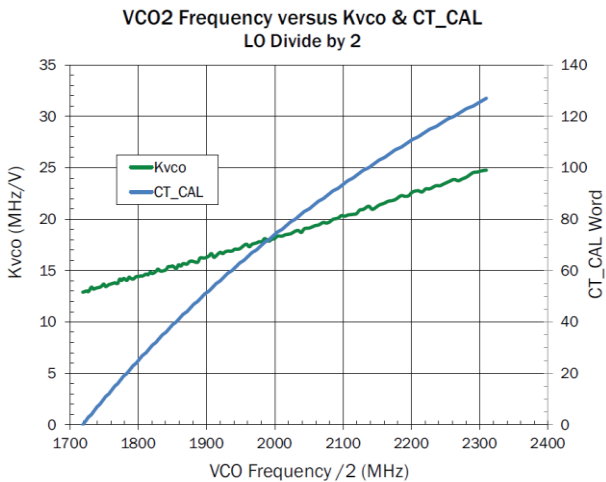
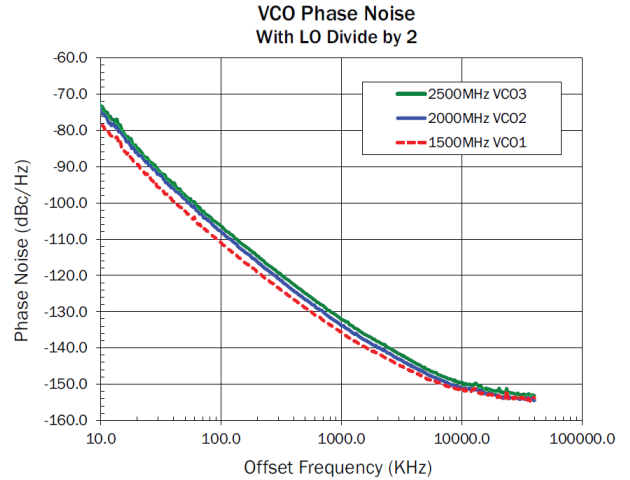
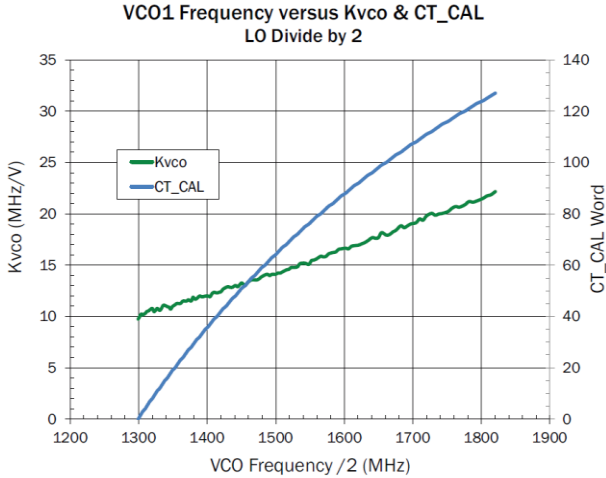

## Typical RF Mixer 2 Performance Characteristics

VDD = +3 V and T<sub>C</sub> = +27 °C unless stated otherwise, on RFFC2071A/RFFC2072A EVB

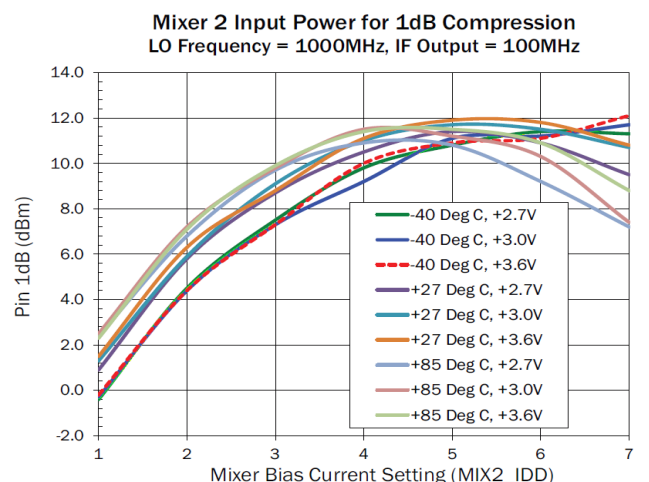
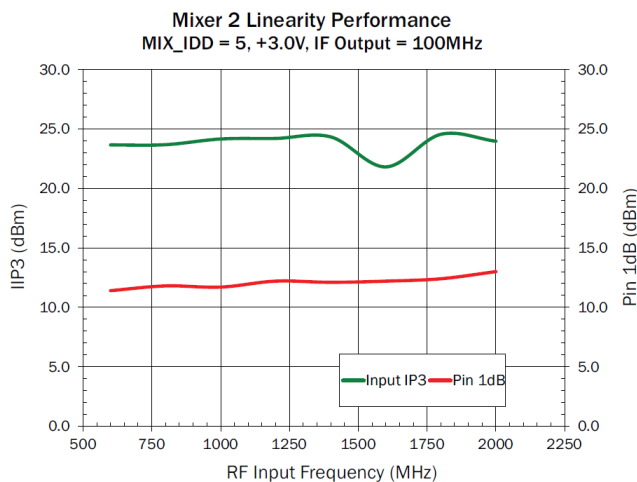
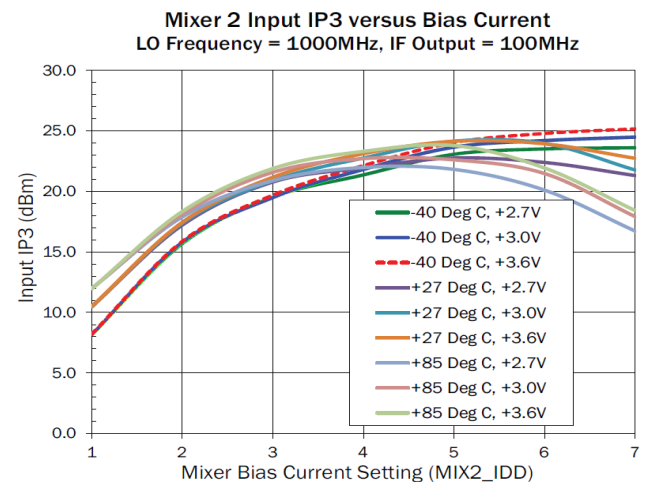
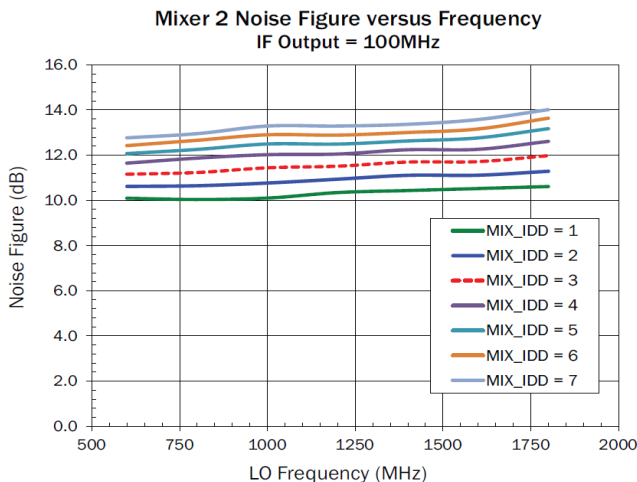
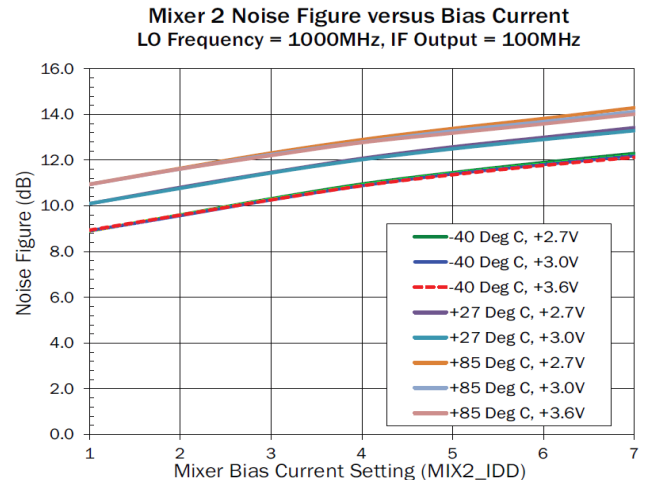
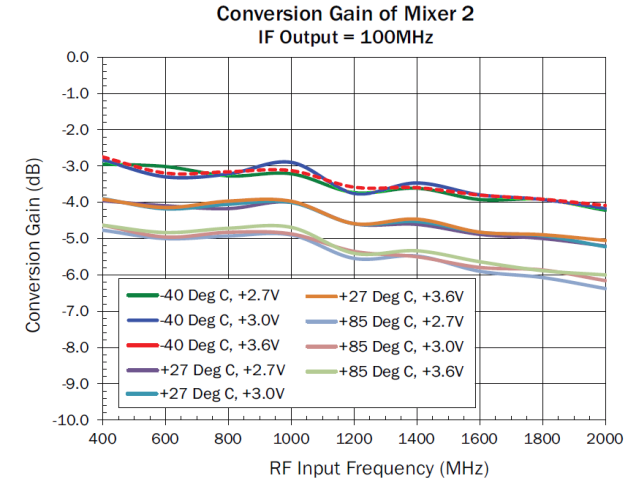

Typical RF Mixer 1 Performance Characteristics

VDD = +3 V and T<sub>C</sub> = +27 °C unless stated otherwise, on RFFC2071A/RFFC2072A EVB

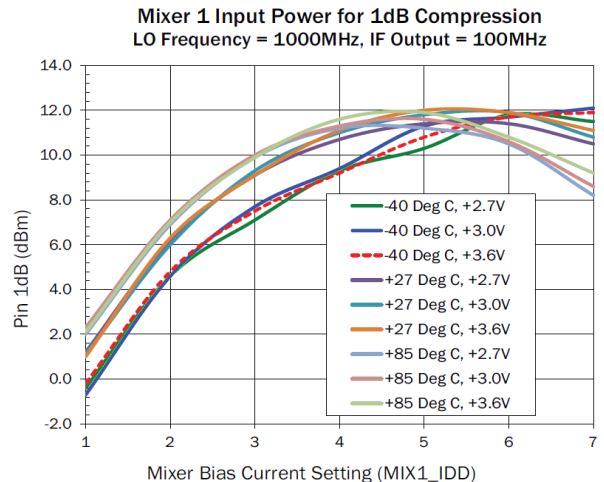
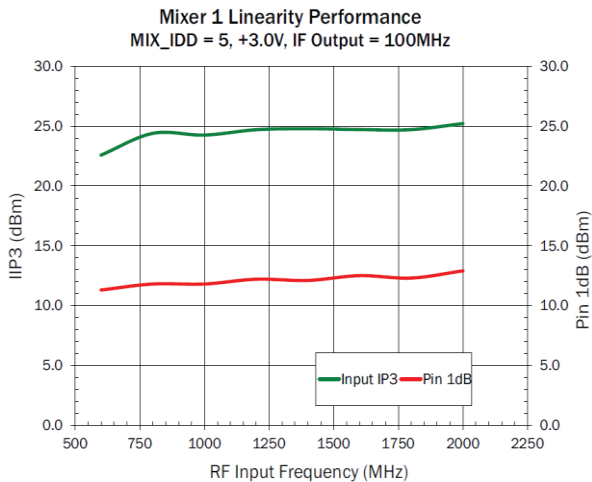
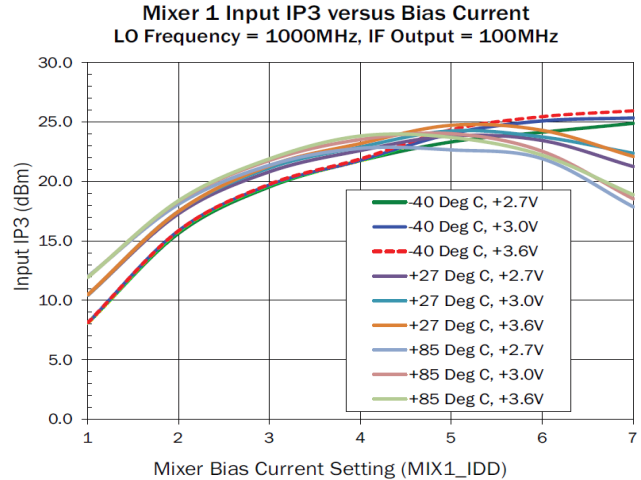
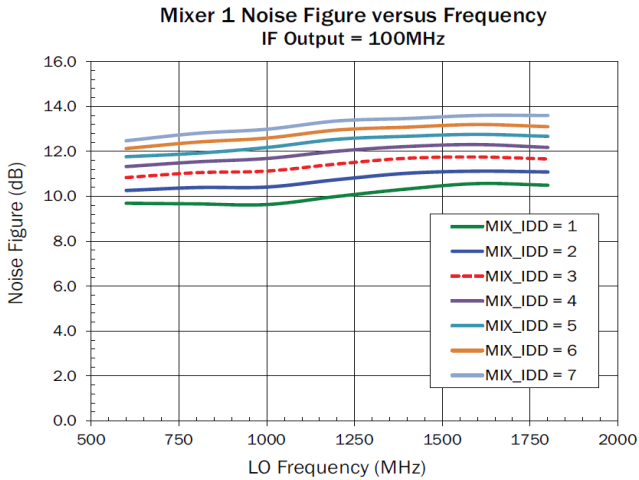
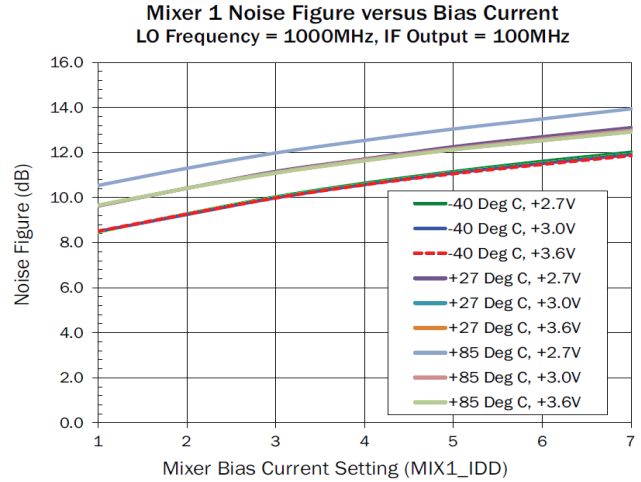
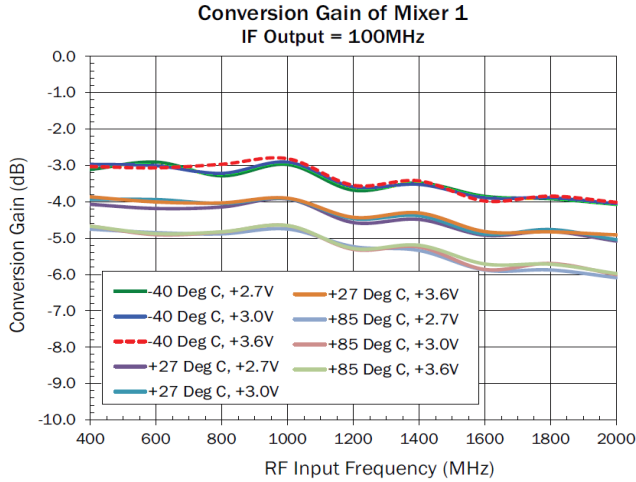



## Typical Performance Characteristics of Both RF Mixers

VDD = +3 V and T<sub>C</sub> = +27 °C unless stated otherwise, on RFFC2071A EVB

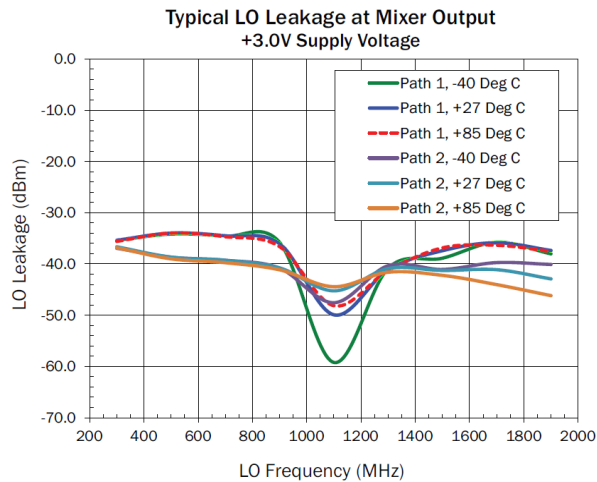
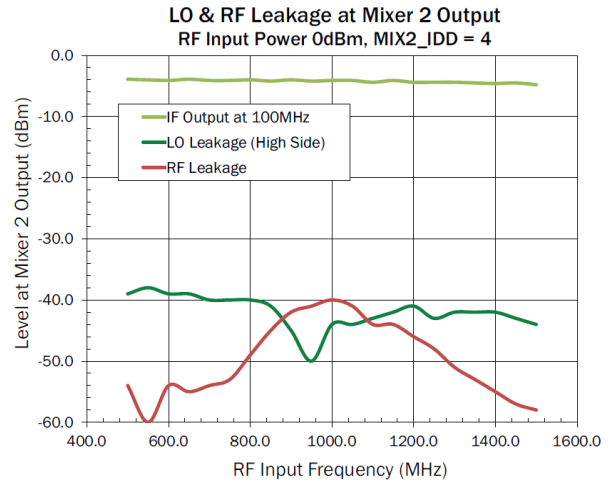
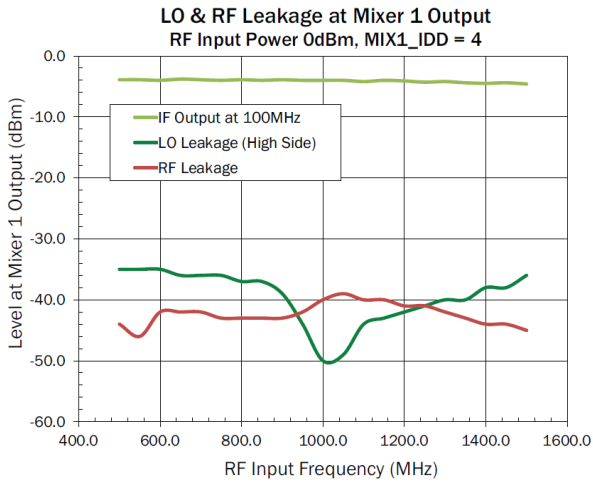

## Typical Full Duplex Mode Performance Characteristics

VDD = +3 V and T<sub>C</sub> = +27 °C unless stated otherwise, on RFFC2071A EVB

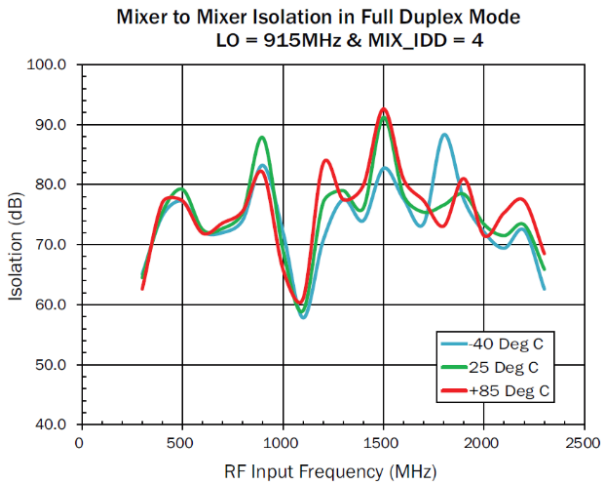
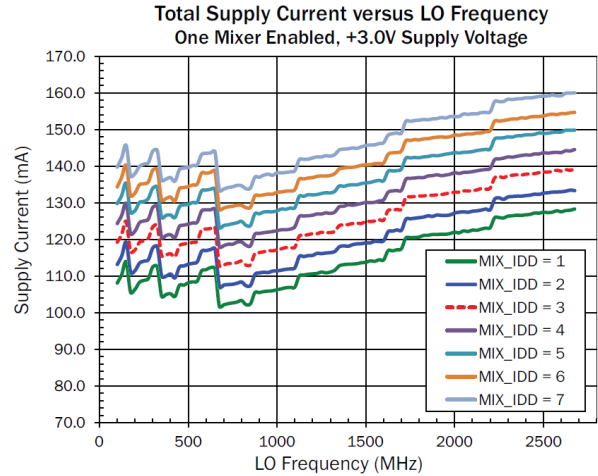
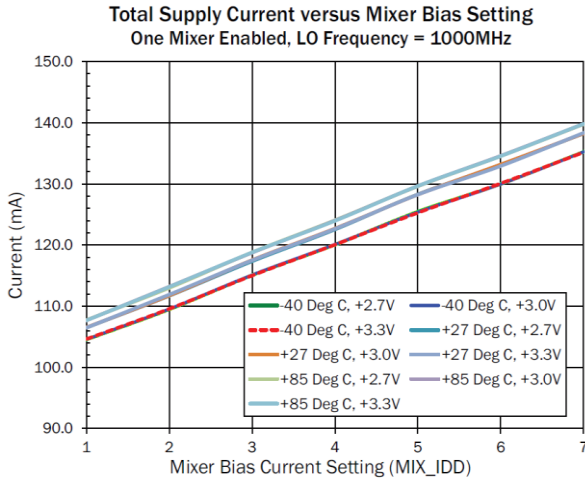

RFF2071A Typical Operating Current in mA in Full Duplex Mode (both mixers enabled) with +3V supply.

MIX2_IDD	MIX1_IDD						
	1	2	3	4	5	6	7
1	129	134	139	144	149	154	159
2	134	139	144	150	155	160	165
3	139	144	150	155	160	165	170
4	144	150	155	160	165	170	175
5	149	155	160	165	170	175	180
6	154	160	165	170	175	180	185
7	159	164	170	175	180	185	190

## Pin Configuration and Descriptions

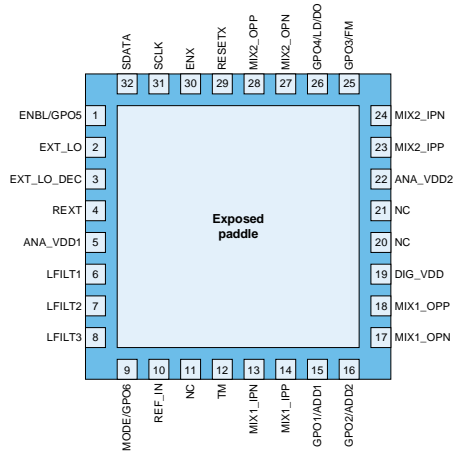

RFFC2071A

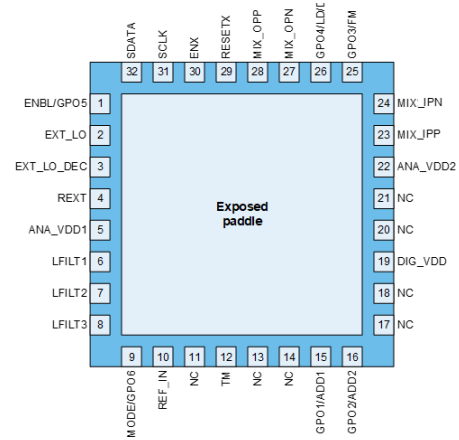

RFFC2072A

Pin No.	Label	Description
1	ENBL/GPO5	Device Enable pin <sup>(1)</sup> <sup>(2)</sup>
2	EXT_LO	External local oscillator input <sup>(4)</sup>
3	EXT_LO_DEC	Decoupling pin for external local oscillator <sup>(4)</sup>
4	REXT	External bandgap bias resistor <sup>(3)</sup>
5	ANA_VDD1	Analog supply 1. Use good RF decoupling
6	LFILT1	Phase detector output. Low-frequency noise-sensitive node
7	LFILT2	Loop filter Op-Amp output. Low-frequency noise-sensitive node
8	LFILT3	VCO control input. Low-frequency noise-sensitive node
9	MODE/GPO6	Mode select pin <sup>(1)</sup> <sup>(2)</sup>
10	REF_IN	Reference input. Use AC coupling capacitor
11, 20, 21	NC	No internal connection; Leave circuit open on Pin 20
12	TM	Connect to ground.
13, 14	MIX1_IPN, MIX1_IPP	Mixer 1 Differential input <sup>(4)</sup> ; on RFFC2072A these two pins are NC
15	GPO1/ADD1	General purpose output 1 / Multi-Slice address bit 1.
16	GPO2/ADD2	General purpose output 2 / Multi-Slice address bit 2.
17, 18	MIX1_OPN, MIX1_OPP	Mixer 1 Differential output <sup>(5)</sup> on RFFC2072A these two pins are NC
19	DIG_VDD	Digital supply. Should be decoupled as close to the pin as possible
22	ANA_VDD2	Analog supply 2. Use good RF decoupling
23, 24	MIX2_IPP, MIX2_IPN	Mixer 2 Differential input <sup>(4)</sup>
25	GPO3/FM	General purpose output 3 / frequency control input
26	GPO4/LD/DO	General purpose output 4 / Lock detect output / serial data out
27, 28	MIX2_OPN, MIX2_OPP	Mixer 2 Differential output <sup>(5)</sup>
29	RESETX	Chip reset (active low). Connect to DIG_VDD if asynchronous reset is not required.
30	ENX	Serial interface select (active low) <sup>(1)</sup>
31	SCLK	Serial interface clock <sup>(1)</sup>
32	SDATA	Serial interface data <sup>(1)</sup>
Exposed Paddle		Ground reference, should be connected to PCB ground through a low impedance path

**Notes:**

1. An RC low-pass filter could be used on this line to reduce digital noise.
2. If the device is under software control this input can be configured as a general-purpose output (GPO).
3. Connect a 51 kΩ resistor from this pin to ground. This pin is sensitive to low frequency noise injection.
4. DC voltage should not be applied to this pin. Use either an AC coupling capacitor as part of lumped element matching network or a transformer (see application schematic).
5. This pin must be connected to ANA\_VDD2 using an RF choke or transformer (see application schematic).

## Package Marking and Dimensions

Marking: Part Number – RFFC2071A or RFFC2072A  
 YYWW – Date Code, Two digits Year and Week  
 Trace Code – Assigned by subcontractor

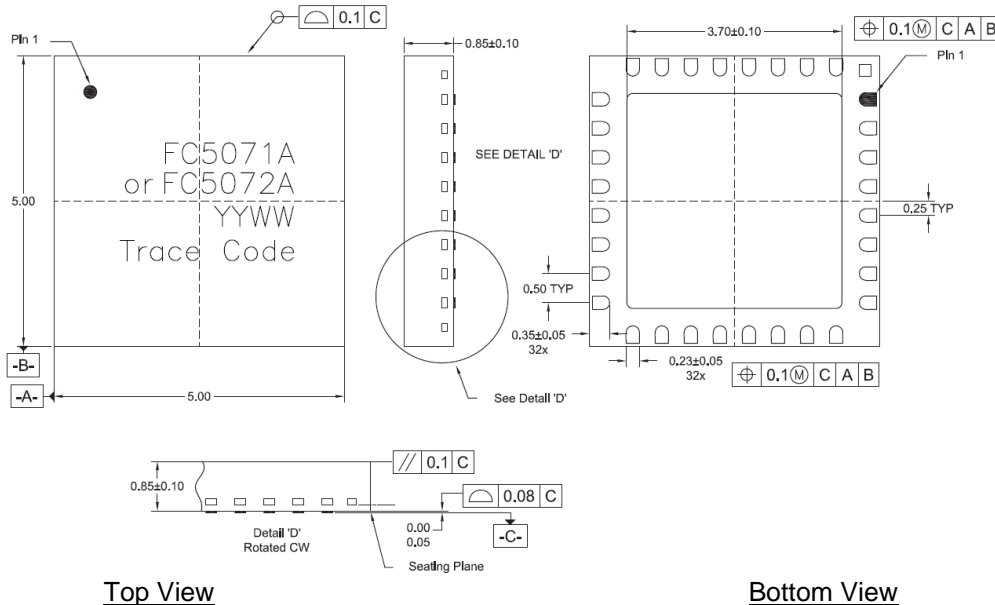

Top View

Bottom View

**Notes:**

1. All dimensions are in millimeters. Angles are in degrees.
2. The terminal #1 identifier and terminal numbering conform to JESD 95-1 SPP-012.
3. Contact plating: Matte Sn

## PCB Mounting Pattern

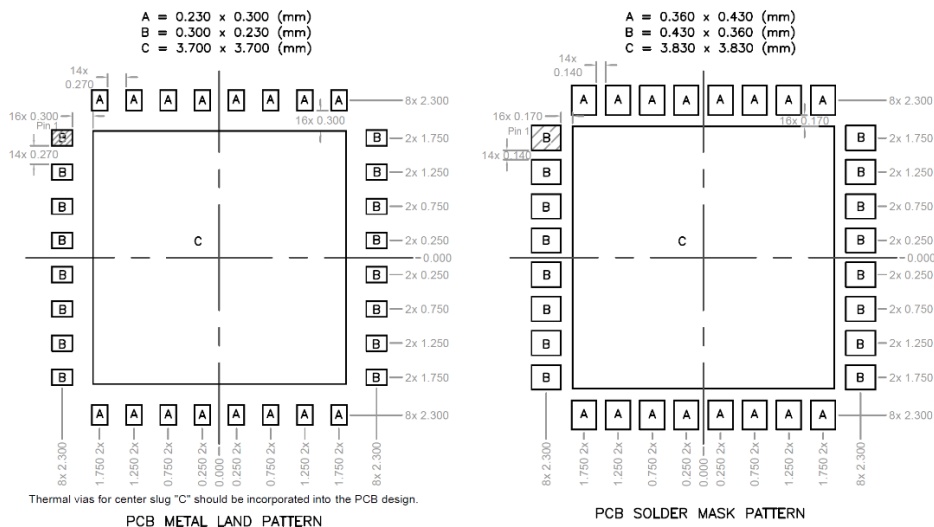

**Notes:**

1. All dimensions are in millimeters. Angles are in degrees.
2. Use 1 oz. copper minimum for top and bottom layer metal.
3. Via holes are required under the backside paddle of this device for proper RF/DC grounding and thermal dissipation. We recommend a 0.35mm (#80/.0135") diameter bit for drilling via holes and a final plated thru diameter of 0.25 mm (0.01").
4. Ensure good package backside paddle solder attach for reliable operation and best electrical performance.

Tape and Reel Information – Carrier and Cover Tape Dimensions

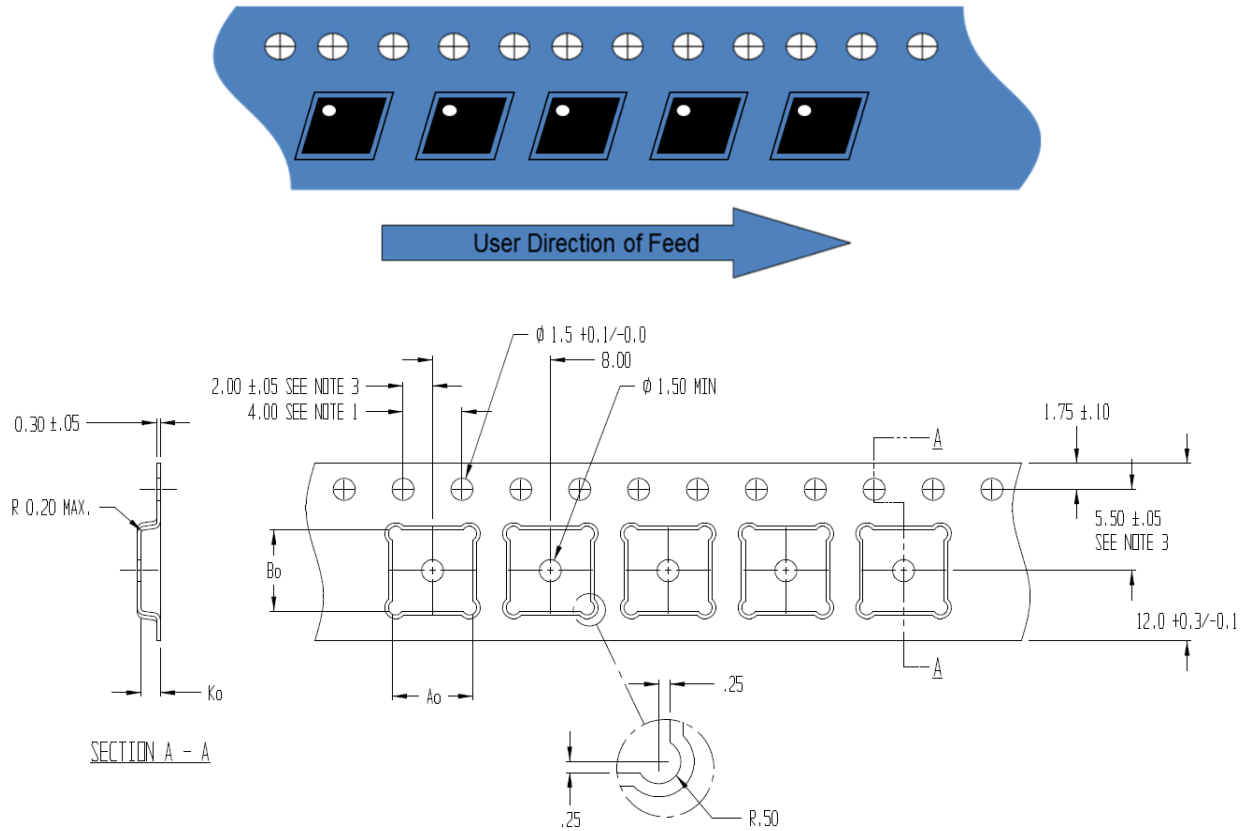

Feature	Measure	Symbol	Size (in)	Size (mm)
Cavity	Length	A0	0.207	5.25
	Width	B0	0.207	5.25
	Depth	K0	0.051	1.30
	Pitch	P1	0.315	8.00
Centerline Distance	Cavity to Perforation - Length Direction	P2	0.079	2.00
	Cavity to Perforation - Width Direction	F	0.217	5.50
Cover Tape	Width (Refence only)	C	0.362	9.20
Carrier Tape	Width	W	0.472	12.00

**Tape and Reel Information – Reel Dimensions**

Standard T/R size = 2,500 pieces on a 13" reel.

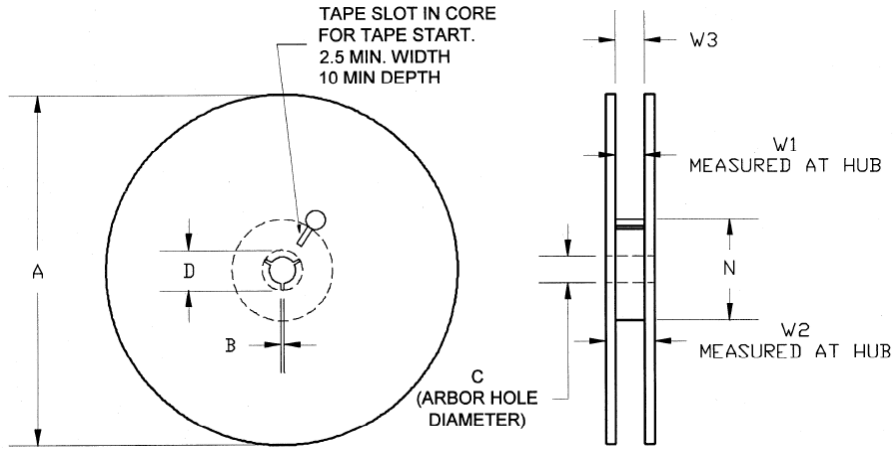

Feature	Measure	Symbol	Size (in)	Size (mm)
Flange	Diameter	A	12.992	330.0
	Thickness	W2	0.717	18.2
	Space Between Flange	W1	0.504	12.8
Hub	Outer Diameter	N	4.016	102.0
	Arbor Hole Diameter	C	0.512	13.0
	Key Slit Width	B	0.079	2.0
	Key Slit Diameter	D	0.787	20.0

**Tape and Reel Information – Tape Length and Label Placement**

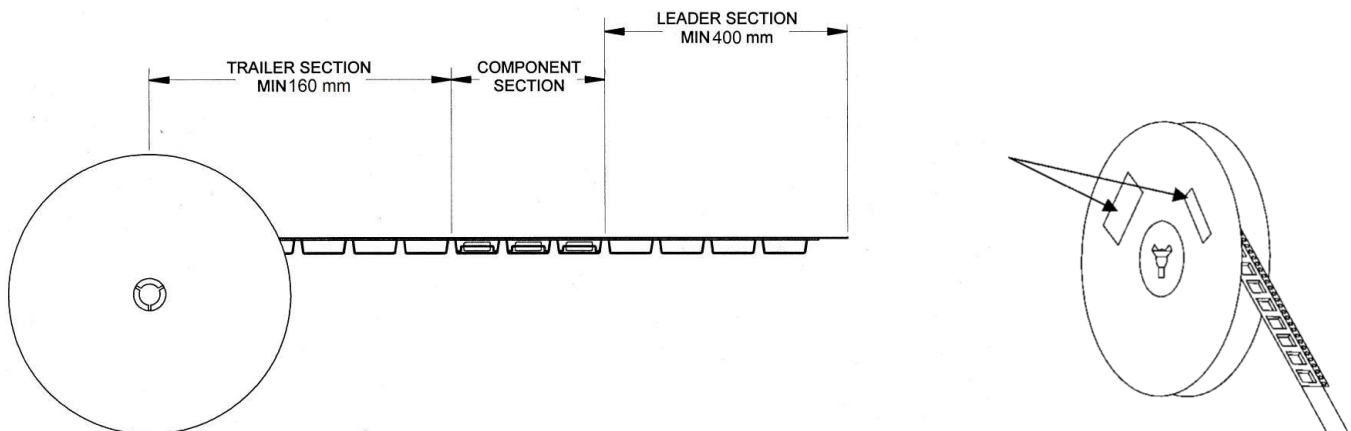

- Notes:
1. Empty part cavities at the trailing and leading ends are sealed with cover tape. See EIA 481-1-A.
  2. Labels are placed on the flange opposite the sprockets in the carrier tape.