

DATA CONTAINED ON THIS DOCUMENT IS PROPRIETARY TO TROMPETER ELECTRONICS, INC. AND SHALL NOT BE DISCLOSED, COPIED OR USED FOR REPRODUCTION OR MANUFACTURE WITHOUT EXPRESS WRITTEN PERMISSION.

DASH NO	DESCRIPTION
-1	CAP (NO CHAIN)
-2	CAP WITH 2.5 BRASS CHAIN
-3	CAP WITH 2.5 NYLON CHAIN
-4	CAP WITH 3.0 BRASS CHAIN
-5	CAP WITH 3.0 NYLON CHAIN
-6	CAP WITH 6.0 BRASS CHAIN
-7	CAP WITH 6.0 NYLON CHAIN
-8	CAP WITH 4.0 BRASS CHAIN
-9	CAP WITH 4.0 NYLON CHAIN
-10	CAP WITH 10.0 BRASS CHAIN
-11	CAP WITH 10.0 NYLON CHAIN
-12	CAP WITH 2.5 INCH SST ROPE
-13	CAP WITH 3.0 INCH SST ROPE
-14	CAP WITH 6.0 INCH SST ROPE
-15	CAP WITH 4.0 INCH SST ROPE
-16	CAP WITH 7.0 INCH SST ROPE
-17	CAP WITH 4.5 INCH SST ROPE

MODEL NO	TYPE
RFI85	2-LUG
RFI853	3-LUG
RFI385	THREAD

DASH NO	"A" DIA	"B" DIA	"C" DIM	"D" DIM
-D1	.755	.875	1.191	.513
-D2	.630	.750	1.066	.450
-D3	.505	.625	.941	.388
-D4	.439	.562	.878	.355
-D5	.380	.500	.816	.325
-D6	.317	.437	.753	.295
-D7	.281	.406	.722	.278
-D8	.610	.750	1.066	.450
-D9	.567	.687	1.003	.419
-DD8	.330	.450	.766	.300
-D10	.192	.312	.628	.231

REV		ED	DESCRIPTION	DWN	APPROVED	DATE
F	13	357	ADDED -12-01 THRU -17-008, -112-01 THRU -117-008, -812-01 THRU -817-008 AND ITEM 16 TO BOM FOR SST WITH D-LUG B-3265-1 UPGRADE TO LARGER FORMAT, UPGRADE TABLE 1 AND 2; ADDED VIEW FOR SST ROPE & D-LUG; CHANGED NOTE 4; .56 ± .03 WAS .500 ± .030; GENERAL UPDATE; SEE ECO	OKC	<i>[Signature]</i>	

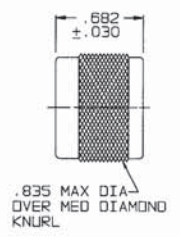

RFI385-1
SHOWN
NO CHAIN/ROPE OR MOUNTING LUG

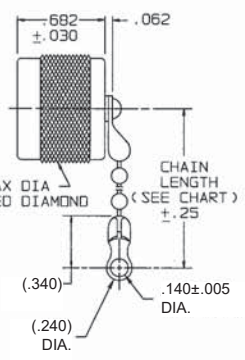

RFI385-2 THRU
-10 SHOWN
STANDARD CHAIN & MOUNTING LUG

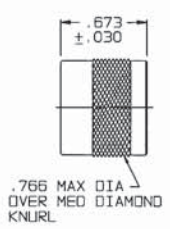

RFI85/
RFI853-1
SHOWN
NO CHAIN/ROPE OR MOUNTING LUG

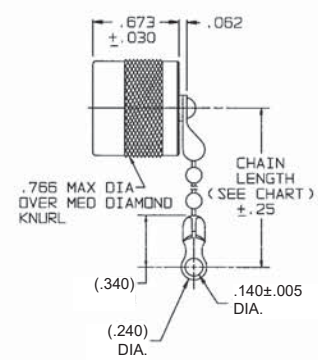

RFI85/RFI853-2 THRU
-11 SHOWN
STANDARD CHAIN & MOUNTING LUG

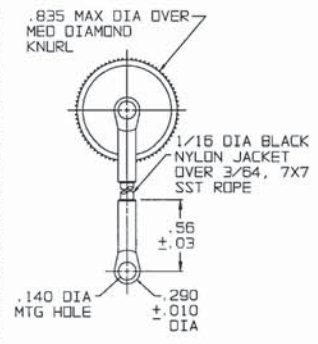

RFI385-12 THRU
-17 SHOWN
STAINLESS STEEL ROPE AND MOUNTING LUG

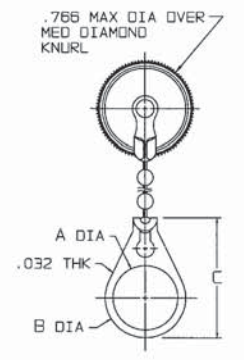

RFI85/RFI853-2-01
THRU -11-008 SHOWN
STANDARD CHAIN AND BULKHEAD JACK MOUNTING LUG

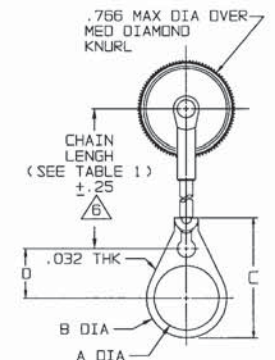

RFI85/RFI853-12-01
THRU -17-008 SHOWN
SST ROPE AND BULKHEAD JACK MOUNTING LUG

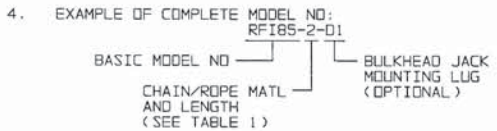

- MALE "C" STYLE DUST CAP
- FINISH: NICKEL
- ALL DIM ARE IN INCHES

QTY	DESCRIPTION	PART NUMBER	ITEM
TOL. UNLESS SPECIFIED - .001 ± .005 - .0002 - ANALYSIS	TROMPETER ELECTRONICS, INC.	RFI 85/853/385	
DWN CHK ENGR APPV	DATE: 3-21-00 SCALE: 2/1	MATERIAL: 14949 CODE IDENT: 305-0137	REV: F
NEXT ASSY	DATE: 11-14-73	SHEET: 1C	