

RFSW6062

Low Insertion High Isolation SP6T Switch
5MHz to 6000MHz

The RFSW6062 is a low loss, high isolation SP6T switch with performance optimized for use in Cellular BTS applications. Plus it is also ideally suited for use in CATV and SATV applications. This part is packaged in a compact 2mm x 2mm, 14-pin, QFN package which allows for a small solution size with no need for external DC blocking capacitors (when no external DC is applied to the device ports).

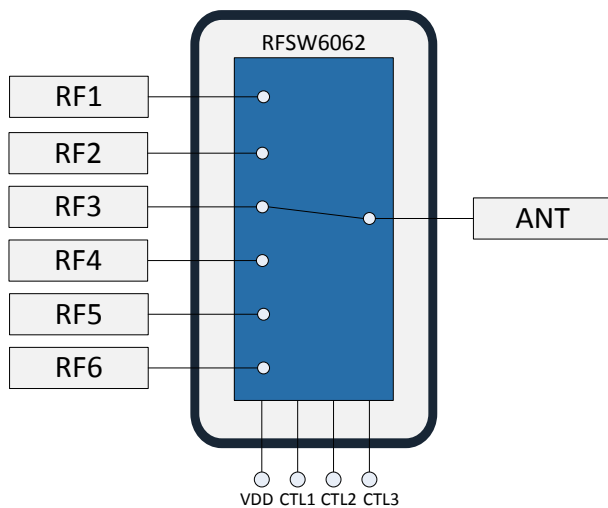

Functional Block Diagram



Package: QFN, 14-pin,
2mm x 2mm

Features

- 5MHz to 6000MHz Operation
- Excellent Insertion Loss and Isolation Performance
 - Low Insertion Loss: 0.53dB at 2GHz
 - High Isolation: 27dB at 2GHz
- High IP3: >70dBm at 2GHz
- Compatible with Low Voltage Logic (V_{HIGH} Minimum = 1.3V)
- No External DC Blocking
 - Capacitors Required on RF Paths if DC is Applied Externally
- 2000V HBM ESD Rating on All Ports
- 3V to 5V Operation

Applications

- Cellular BTS
- CATV, SATV Applications
- Test Equipment
- General Purpose Switch

Ordering Information

RFSW6062SQ	Sample bag with 25 pieces
RFSW6062SR	7" Reel with 100 pieces
RFSW6062TR7	7" Reel with 2500 pieces
RFSW6062PCK-410	5MHz to 3GHz PCBA with 5-piece sample bag
RFSW6062PCK-411	3GHz to 6GHz PCBA with 5-piece sample bag

Absolute Maximum Ratings

Parameter	Rating	Unit
Control Voltage (V_{CTL})	3.0	V
Supply Voltage (V_{DD})	6.0	V
Maximum CW Input Power for $V_{DD} = 3V$	32	dBm
Max Input Power During Active Switching	24	dBm
Storage Temperature Range	-40 to +150	°C
ESD Rating - Human Body Model (HBM)	2000	V
Moisture Sensitivity Level	MSL2	



Caution! ESD sensitive device.



RFMD Green: RoHS status based on EU Directive 2011/65/EU (at time of this document revision), halogen free per IEC 61249-2-21, < 1000ppm each of antimony trioxide in polymeric materials and red phosphorus as a flame retardant, and <2% antimony in solder.

Exceeding any one or a combination of the Absolute Maximum Rating conditions may cause permanent damage to the device. Extended application of Absolute Maximum Rating conditions to the device may reduce device reliability. Specified typical performance or functional operation of the device under Absolute Maximum Rating conditions is not implied.

Recommended Operating Condition

Parameter	Specification			Unit
	Min	Typ	Max	
Operating Temperature Range	-40		+85	°C
V_{DD} – Switch Supply Voltage	3	5	5.5	V

Nominal Operating Parameters

Parameter	Specification			Unit	Condition
	Min	Typ	Max		
General Performance					Electrical Specifications, $T_A=25^\circ\text{C}$, $V_{DD}=3V$ to $5V$
Operating Frequency Range	5		6000	MHz	
Insertion Loss2 (RFC to RF1/RF2/ RF3/RF4/RF5/RF6)		0.4	0.45	dB	925MHz
		0.53	0.6	dB	1990MHz
		0.68	0.78	dB	2650MHz
		1.85		dB	5850MHz
Isolation (RFC to RF1/RF2/RF3 / RF4RF5/RF6)	31	40		dB	925MHz
	22	29		dB	1990MHz
	19	25		dB	2650MHz
		13.5		dB	5850MHz
Isolation (RF1 to RF2/RF3/RF4/ RF5/RF6)	31	40		dB	925MHz
	18	27		dB	1990MHz
	18	23		dB	2650MHz
		13.5		dB	5850MHz
Return Loss (On State)		24		dB	5MHz ~ 3GHz
Return Loss (On State)		11		dB	3GHz ~ 6GHz
824MHz Second Harmonic		-105	-88	dBc	$P_{in} = 28\text{dBm}$

Parameter	Specification			Unit	Condition
	Min	Typ	Max		
824MHz Third Harmonic		-89	-86	dBc	
2000MHz Second Harmonic		-97	-91	dBc	
2000MHz Third Harmonic		-86	-78	dBc	
Input IP3		71		dBm	2Ghz, 21dBm per tone, 1MHz spacing
Max Operational Input Power		32		dBm	
Power Supply					
V _{DD} Supply Current		65	120	μA	
CTL1, CTL2 – Control Voltage High	1.3		2.7	V	
CTL1, CTL2 – Control Voltage Low	0		0.45	V	
Control Current			5	μA	
Switching Speed, One RF Port to Another		2	5	us	10% to 90% RF
Turn On Time			20	us	Time for V _{DD} = 0V to part ON and RF = 90%

Power-up / Power-down Sequence and Operation Controls

Power-up / Power-down	Sequence for Power-up and Power-down from Supply that is Connected to V _{DD} Pin
Power-up	Turn on VDD, then CTL1, CTL2, and CTL3 then (20μs or greater), apply RF signal
Power-down	Turn off RF signal, then CTL1, CTL2, and CTL3, then turn off V _{DD}
Switching Ports	Turn off RF signal, then change CTL1, CTL2, and CTL3 state, then (5μs or greater). Turn on RF signal

Switch is controlled by CTL1, CTL2, and CTL3

Mode	CTL1	CTL2	CTL3
RF1-ANT	High	Low	Low
RF2-ANT	Low	High	Low
RF3-ANT	High	High	Low
RF4-ANT	Low	Low	High
RF5-ANT	High	Low	High
RF6-ANT	Low	High	High

Typical Performance: 5MHz ~ 3000MHz, $V_{DD} = 5V$ unless otherwise noted

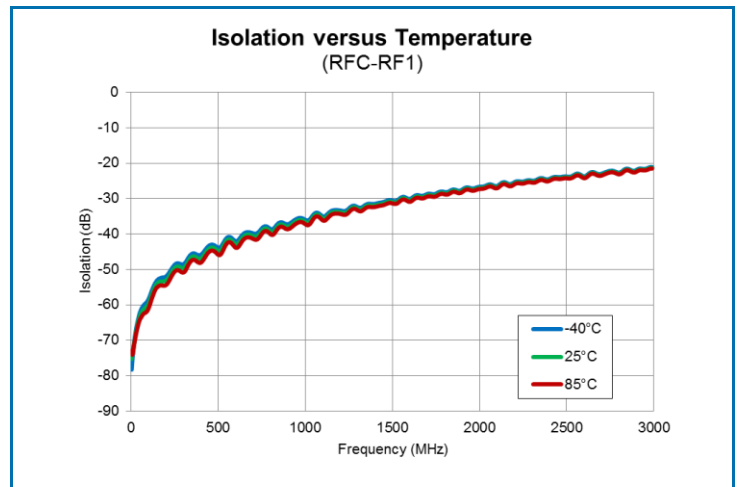
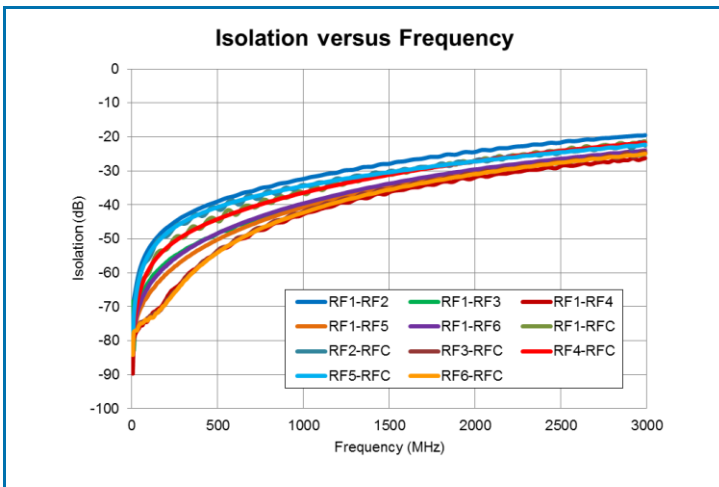
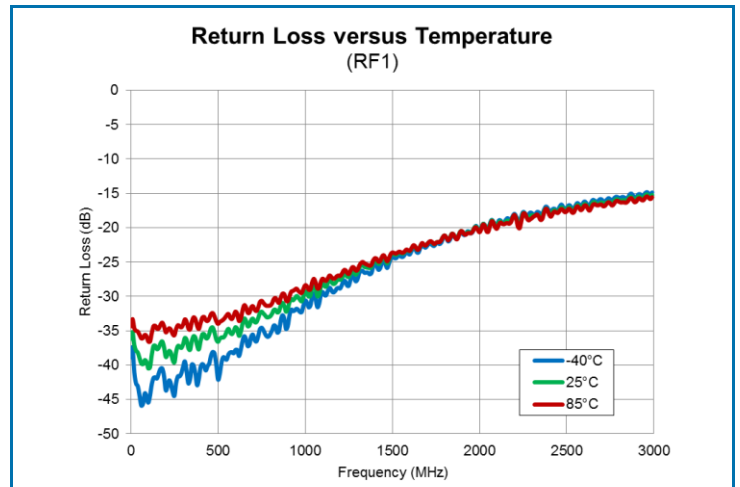
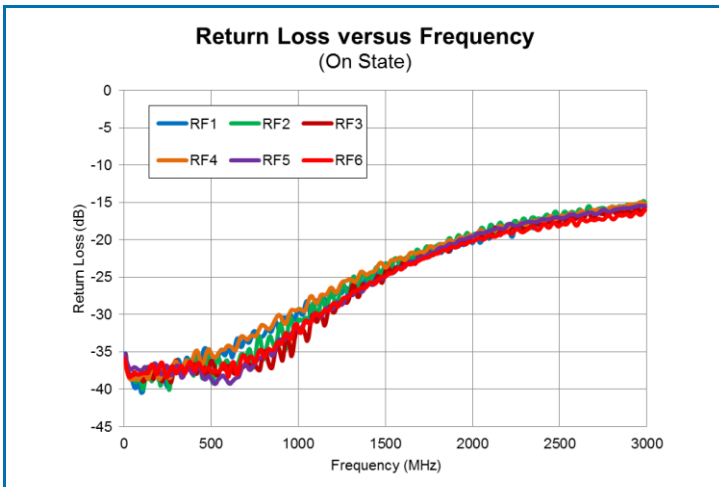
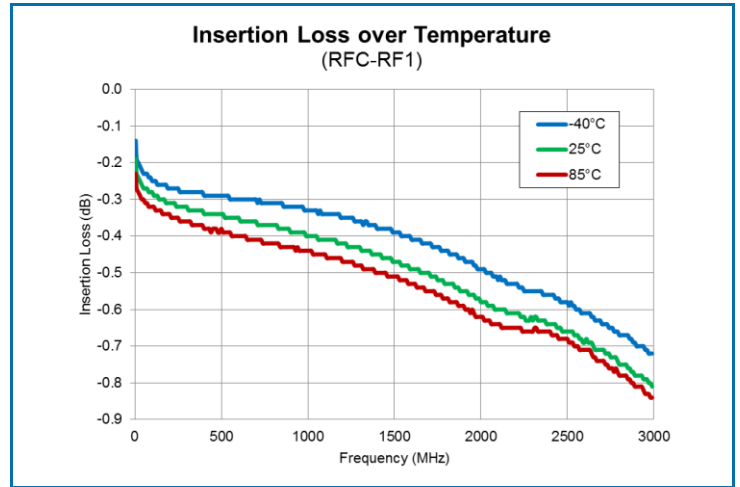
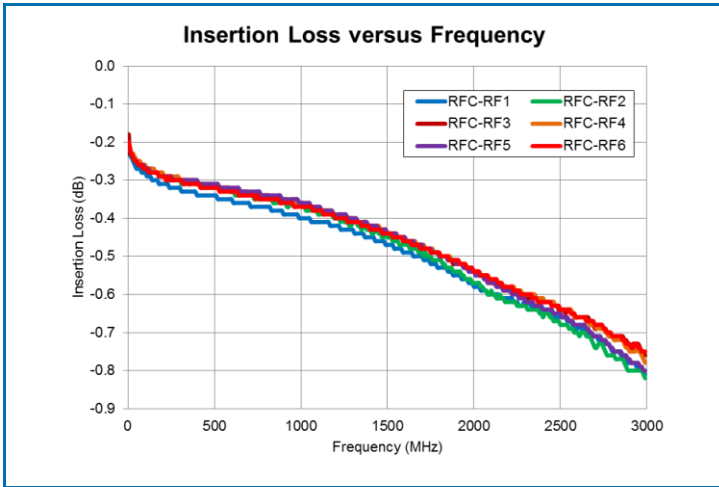

Typical Performance: 5MHz ~ 3000MHz, $V_{DD} = 5V$ unless otherwise noted

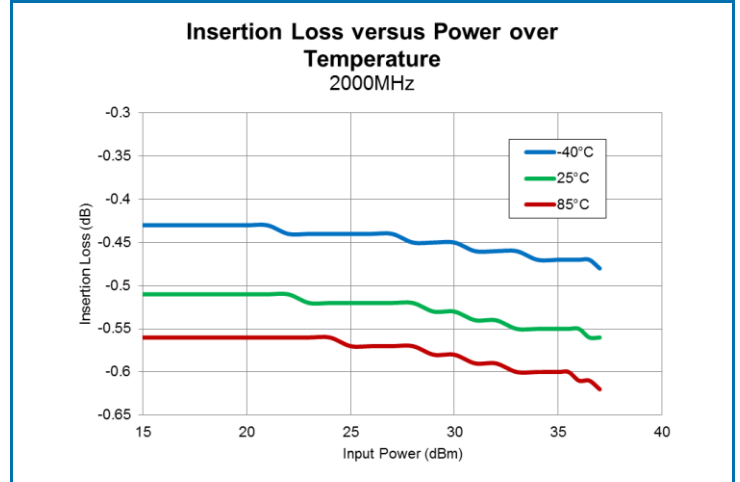
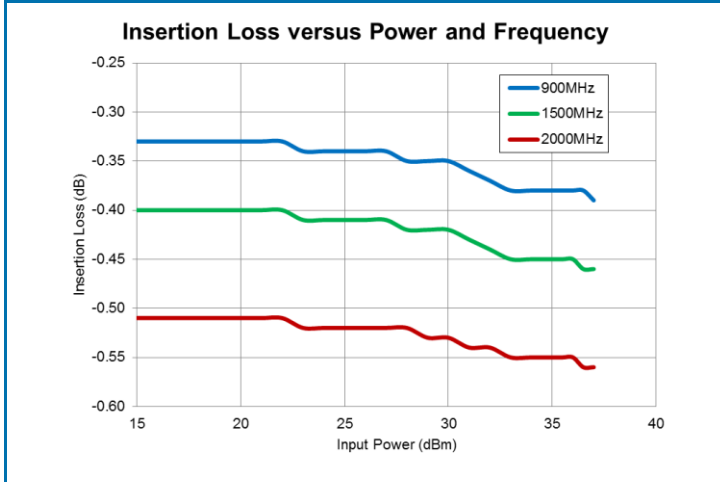

Evaluation Board Schematic 5MHz to 3000MHz Application Circuit

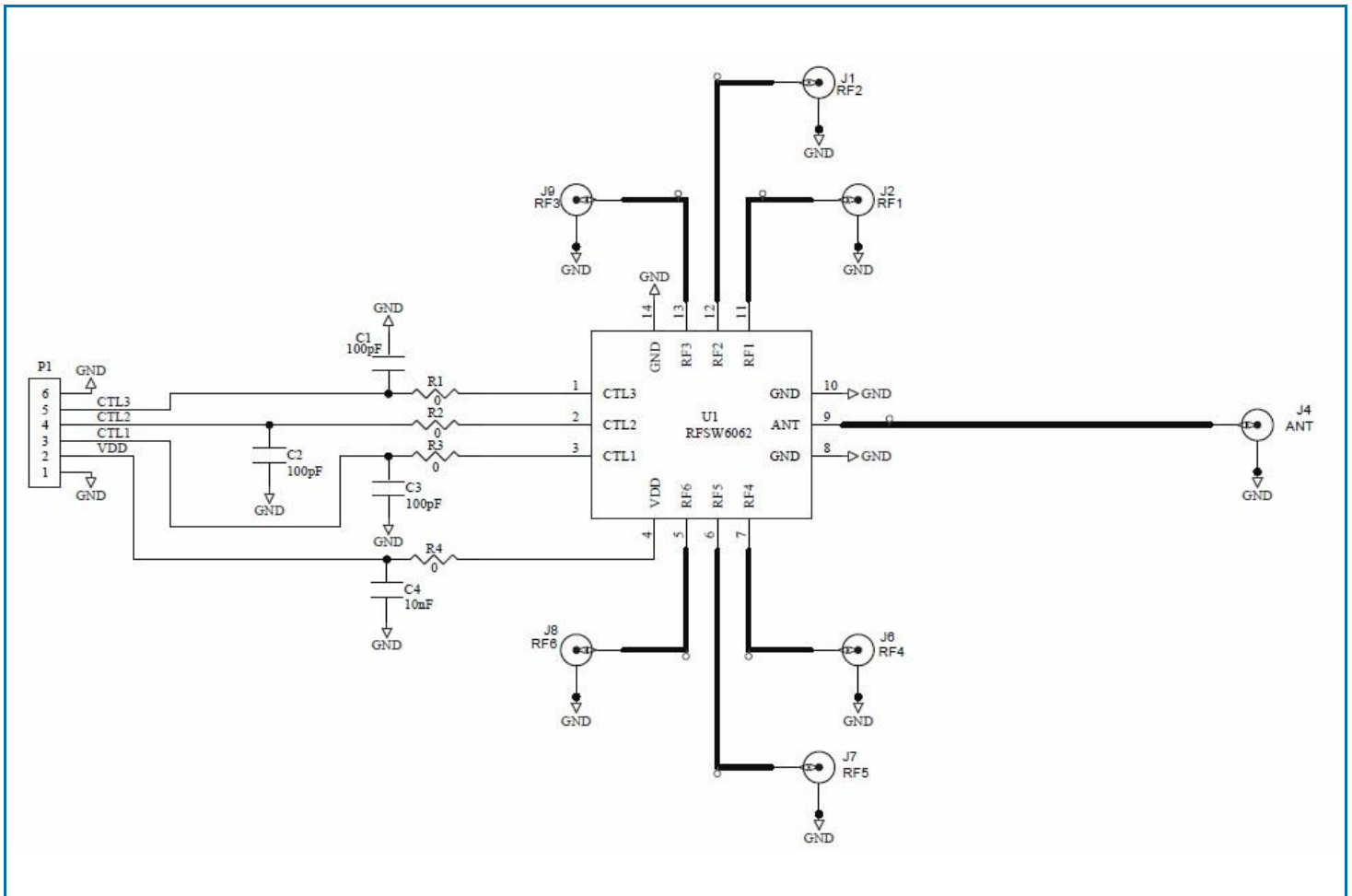

Evaluation Board Bill of Materials (BOM) 5MHz to 3000MHz Application Circuit

Description	Reference Designator	Manufacturer	Manufacturer's P/N
RFSW6062 Evaluation Board			RFSW6062-410
CAP, 100pF, 5%, 50V, C0G, 0402	C1-C3	Murata Electronics	GRM1555C1H101JA01D
CAP, 10000pF, 10%, 25V, X7R, 0402	C4	Murata Electronics	GRM155R71E103KA01D
RES, 0Ω, 0402	R1-R3	Kamaya, Inc.	RMC1-16SJPTH
CONN, SMA, END LNCH, MINI, FLT, 0.068"	J1-J2, J4, J6-J9	Emerson Network Power	142-0741-851
CONN, HDR, ST, PLRZD, 5-PIN, 0.100"	P1	ITW Pancon	MPSS100-5-C
High Power SP6T	U1	RFMD	RFSW6062

Typical Performance: 3000MHz ~ 6000MHz, $V_{DD} = 5V$ unless otherwise noted

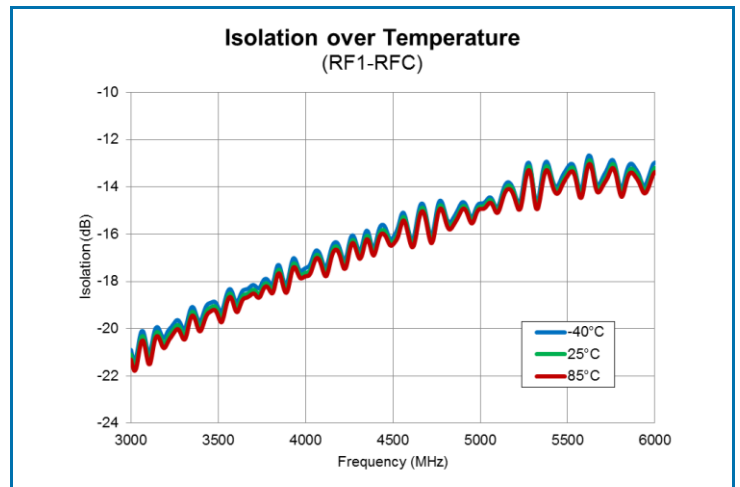
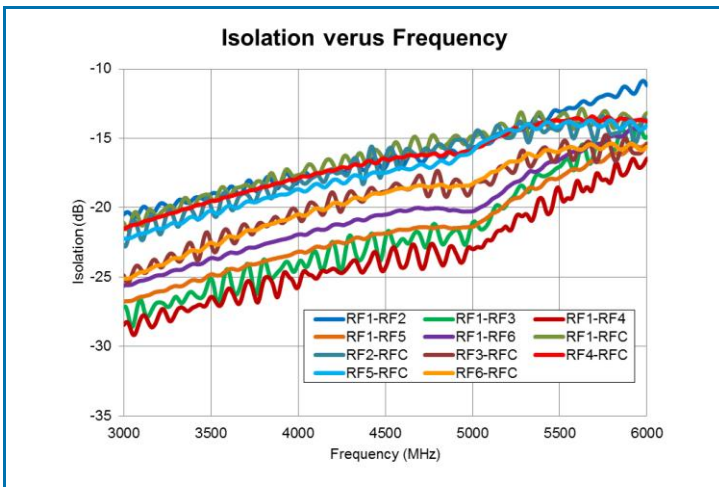
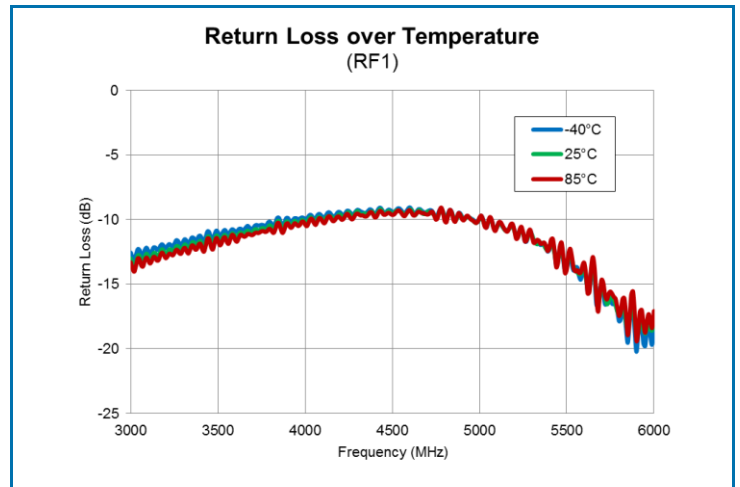
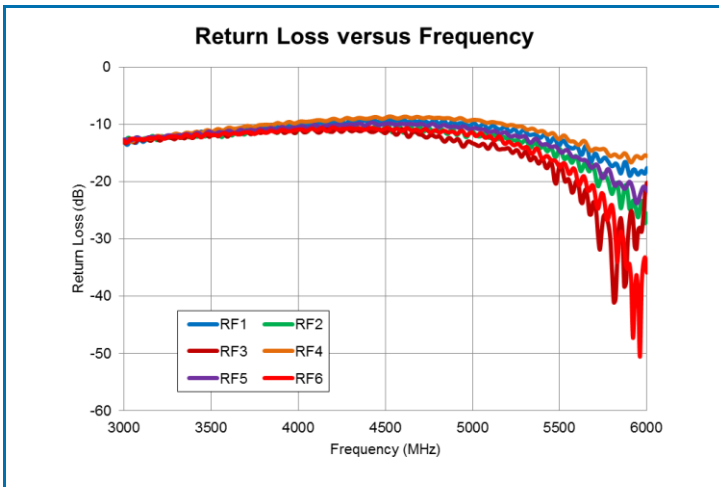
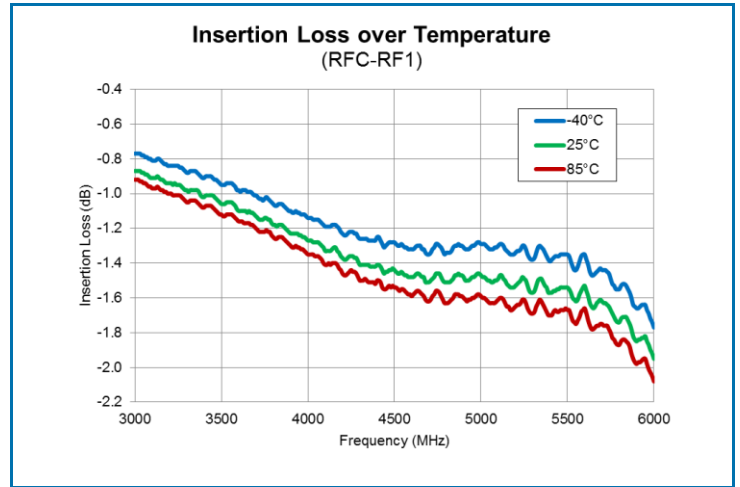
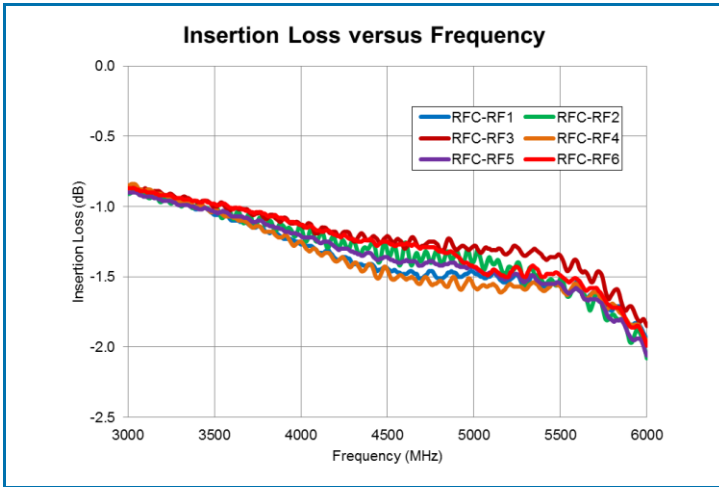

Typical Performance: 3000MHz ~ 6000MHz, $V_{DD} = 5V$ unless otherwise noted

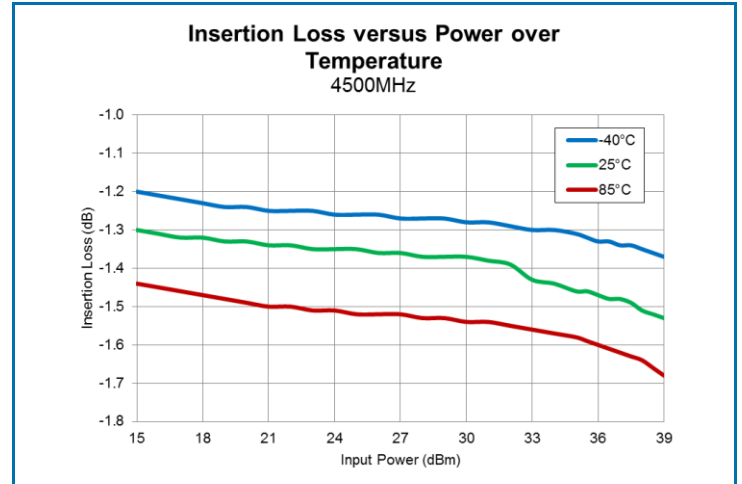
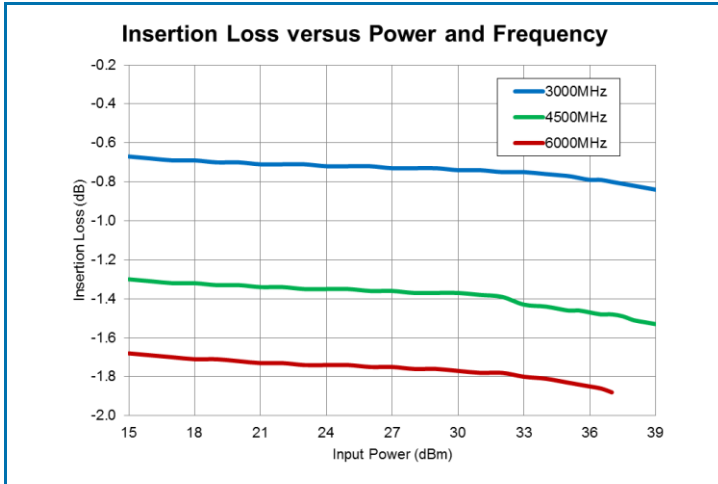

Evaluation Board Schematic 3000MHz to 6000MHz Application Circuit

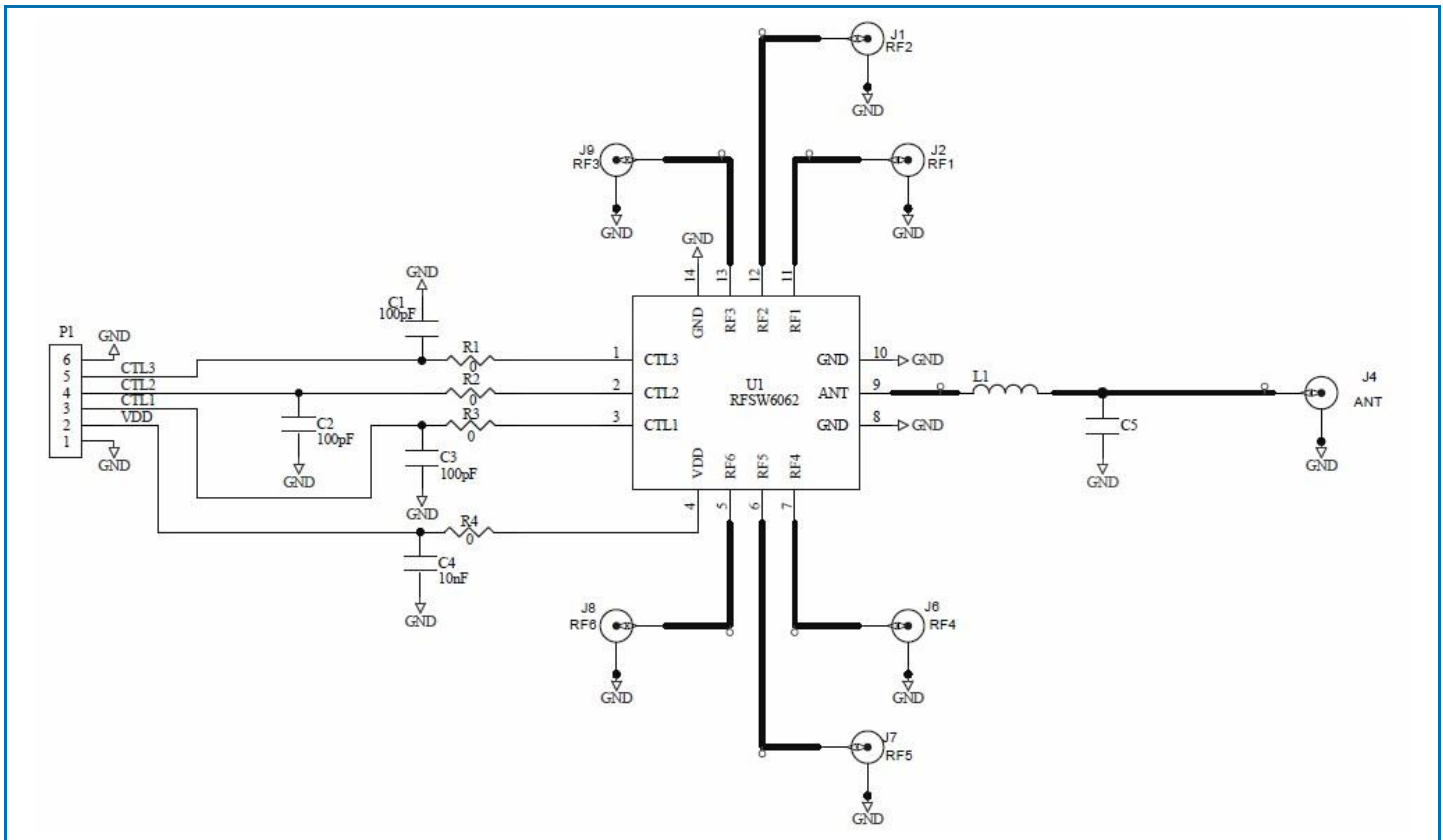

Evaluation Board Bill of Materials (BOM) 3000MHz to 6000MHz Application Circuit

Description	Reference Designator	Manufacturer	Manufacturer's P/N
RFSW6062 Evaluation Board			RFSW6062-410
CAP, 100pF, 5%, 50V, C0G, 0402	C1-C3	Murata Electronics	GRM1555C1H101JA01D
CAP, 10000pF, 10%, 25V, X7R, 0402	C4	Murata Electronics	GRM155R71E103KA01D
CAP, 0.5pF, +/-0.25pF, 50V, C0G, 0402	C5	Murata Electronics	GRM1555C1HR50CA01D
RES, 0Ω, 0402	R1-R4	Kamaya, Inc.	RMC1-16SJPTH
IND, 0.6nH, +/-0.1nH, T/F, 0201	L1	Murata Electronics	LQP03TG0N6B02D
CONN, SMA, END LNCH, MINI, FLT, 0.068"	J1-J2, J4, J6-J9	Emerson Network Power	142-0741-851
CONN, HDR, ST, PLRZD, 5-PIN, 0.100"	P1	ITW Pancon	MPSS100-5-C
High Power SP6T	U1	RFMD	RFSW6062

Evaluation Board Assembly Drawing

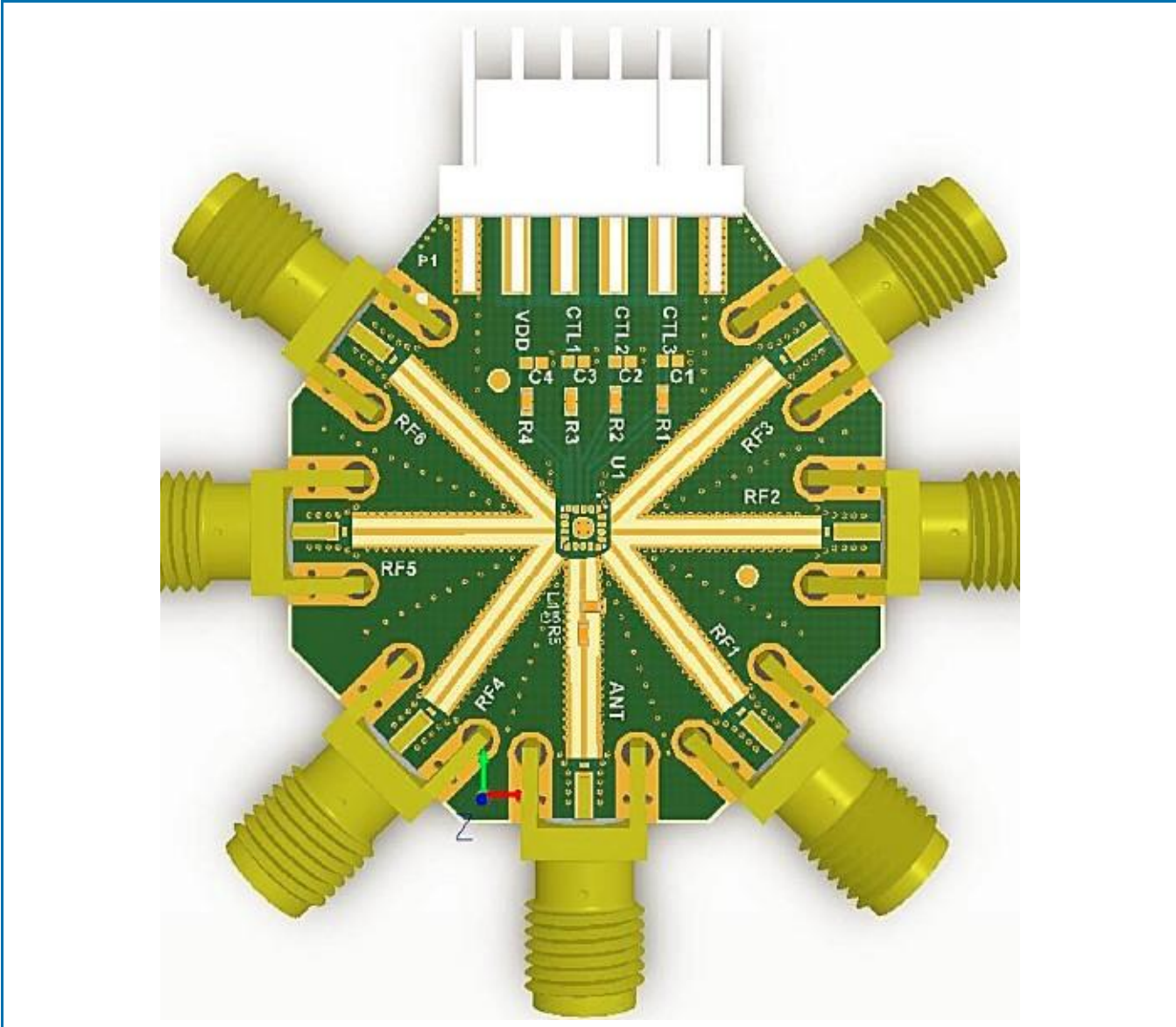

Pin Names and Descriptions

Pin	Name	Description
1	CTL3	Switch logic control 3
2	CTL2	Switch logic control 2
3	CTL1	Switch logic control 1
4	VDD	Supply voltage
5	RF6	Single-ended RF port
6	RF5	Single-ended RF port
7	RF4	Single-ended RF port
8	GND	Low inductance path to ground
9	ANT	Single-ended RF port
10	GND	Low inductance path to ground
11	RF1	Single-ended RF port
12	RF2	Single-ended RF port
13	RF3	Single-ended RF port
14	GND	Low inductance path to ground

Package Outline Drawing (Dimensions in millimeters)

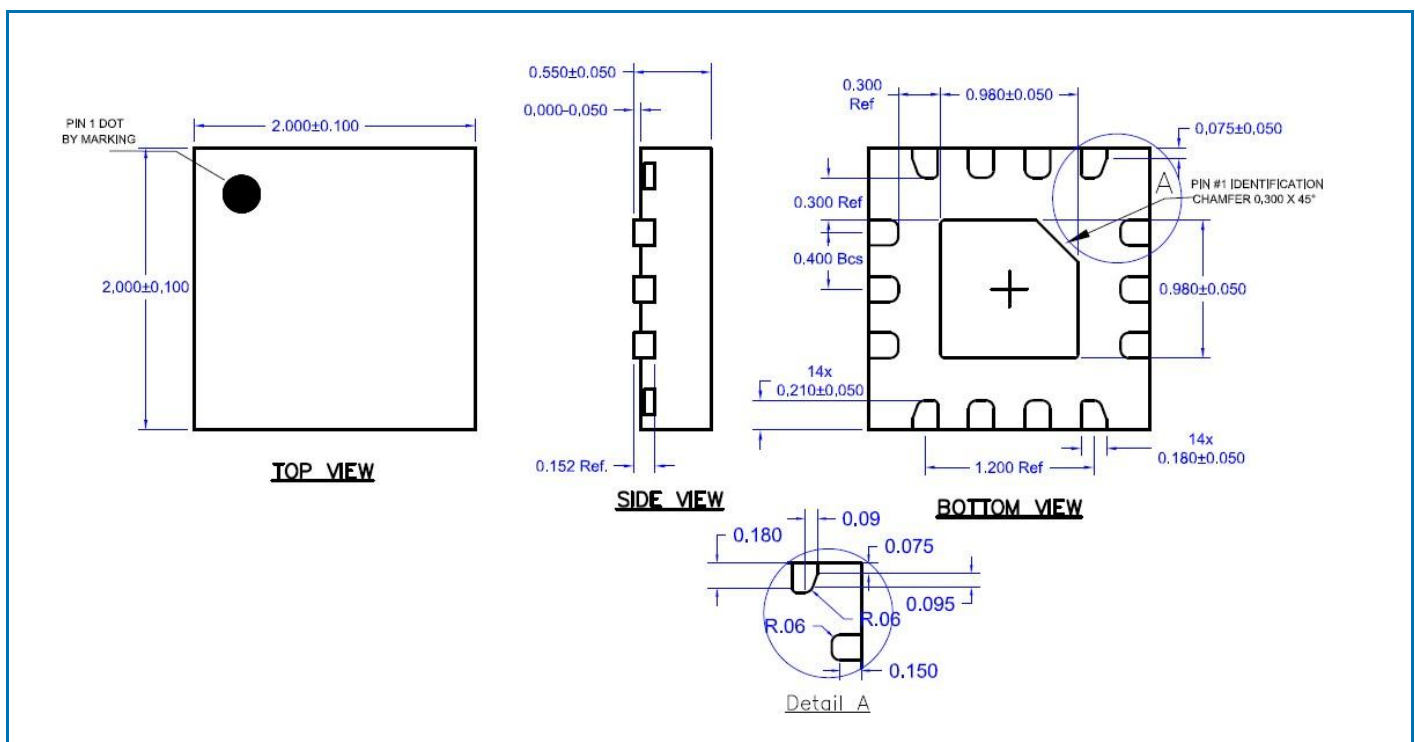

Stencil, PCB Pattern (Dimensions in millimeters)

