

RFSW8000

2.5V to 5.0V, 5MHz to 6500MHz
 10W SPDT Switch

The RFSW8000 is a high power single-pole double-throw (SPDT) switch designed for high performance wireless applications. This wideband switch has been designed for use from 5MHz to 6.5GHz, where extremely high linearity, high isolation, low insertion loss, and small package size are required. Switching for the RFSW8000 is controlled via two control voltage inputs.

The RFSW8000 is manufactured in a pHEMT GaAs process and packaged in an 8-pin, 2.0mm x 2.0mm Dual-Flat-No-Lead (DFN) plastic package.



Package: DFN,
 2.0mm x 2.0mm x 0.55mm

Features

- Single Voltage: 2.5V to 5.0V
- 40dBm P1dB
- 30dB Isolation at 2GHz

Applications

- IEEE 802.11a/n WiFi Systems
- IEEE 802.16 WiMAX Systems
- IEEE 802.15.4 ZigBee Systems
- Customer Premise Equipment (CPE)
- Wireless Access Points, Gateways and Router Applications
- ISM Band Transmitter Applications

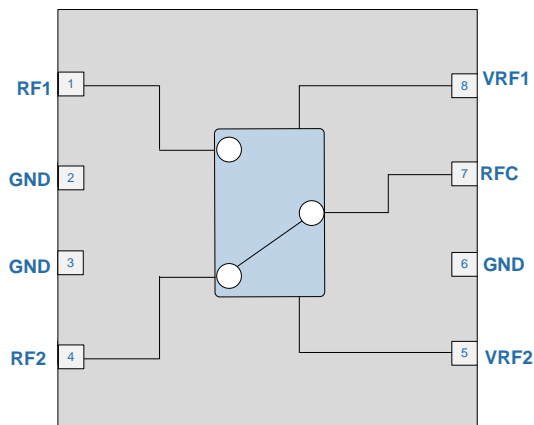

Functional Block Diagram

Ordering Information

RFSW8000SB	Standard 5 piece bag
RFSW8000SQ	Standard 25 piece bag
RFSW8000SR	Standard 100 piece reel
RFSW8000TR7	Standard 2500 piece reel
RFSW8000PCK-410	Eval board (100MHz to 2000MHz) w/5 piece bag
RFSW8000PCK-411	Eval board (2000MHz to 4500MHz) w/5 piece bag
RFSW8000PCK-412	Eval board (4500MHz to 6500MHz) w5 piece bag

Absolute Maximum Ratings

Parameter	Rating	Unit
Supply Voltage (RF Applied)	-0.5 to +5.25	V
Supply Voltage (No RF Applied)	-0.5 to +5.5	V
DC Supply Current	10	mA
Input RF Power	+40*	dBm
Max Input Power, OFDM Modulated, 3:1 Load VSWR	+36	dBm
Operating Ambient Temperature	-40 to +85	°C
Storage Temperature	-40 to +150	°C
Moisture Sensitivity	MSL2	



Caution! ESD sensitive device.



RFMD Green: RoHS status based on EU Directive 2011/65/EU (at time of this document revision), halogen free per IEC 61249-2-21, < 1000ppm each of antimony trioxide in polymeric materials and red phosphorus as a flame retardant, and <2% antimony in solder.

Exceeding any one or a combination of the Absolute Maximum Rating conditions may cause permanent damage to the device. Extended application of Absolute Maximum Rating conditions to the device may reduce device reliability. Specified typical performance or functional operation of the device under Absolute Maximum Rating conditions is not implied.

Nominal Operating Parameters

Parameter	Specification			Unit	Condition
	Min	Typ	Max		
Typical Conditions					Temp = 25°C, VC = 3.0V unless otherwise noted
Performance - Low Band					Optimized at 700 MHz to 950MHz
Frequency	100		2000	MHz	
Insertion Loss		0.4	0.6	dB	
Input P0.1 dB	39	40		dBm	At higher VCONTROL, P0.1dB will be improved
Input Return Loss	20	25		dB	
Isolation	26	29		dB	
Harmonics (2nd, 3rd)		80		dBc	at POUT = 30dBm
IIP3		59		dBm	
Performance - Mid Band					Optimized at 2.1GHz to 2.7GHz
Frequency	2000		4500	MHz	
Insertion Loss		0.55	0.65	dB	In optimized frequency band
			0.95	dB	in full frequency band
Input P0.1 dB	39	40		dBm	At higher VCONTROL, P0.1dB will be improved
Input Return Loss	15	20		dB	
Isolation	26	29		dB	
Harmonics (2nd, 3rd)		80		dBc	at POUT = 30dBm
IIP3		59		dBm	
Performance - High Band					Optimized at 5.1GHz to 5.9GHz
Frequency	4500		6500	MHz	
Insertion Loss		0.85	1	dB	In optimized frequency band
Input P0.1 dB RF1 to RFC	35	36		dBm	At higher VCONTROL, P0.1dB will be improved
Input P0.1 dB RF2 to RFC	37	38		dBm	At higher VCONTROL, P0.1dB will be improved
Input Return Loss	14	20		dB	
Isolation	24	25.5		dB	
Harmonics (2nd, 3rd)		80		dBc	at POUT = 30dBm
IIP3		55		dBm	

Parameter	Specification			Unit	Condition
	Min	Typ	Max		
Switching					
Switching Speed High		300	500	nSec	50% CTL to 90/10% RF
Switching Speed Low		100	300	nSec	90/10% RF to 10/90% RF
Control Voltage					
Control Voltage High	2.5	3	5	V	
Control Voltage Low			0.2	V	
Control Current		5		μA	
Generic Performance					
ESD					
Human Body Model	250			V	EIA/JESD22-114A RF pins
	500			V	EIA/JESD22-114A DC pins
Charge Device Model	1000			V	JESD22-C101C all pins

Control Truth Table

Switch status		Logic Control	
RF1 to RFC	RF2 to RFC	VRF1	VRF2
ON	OFF	High	Low
OFF	ON	Low	High

Performance Plots: 100MHz to 1000MHz

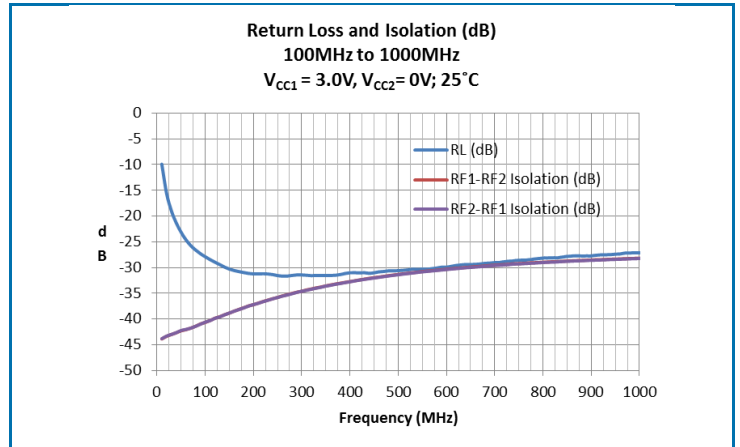
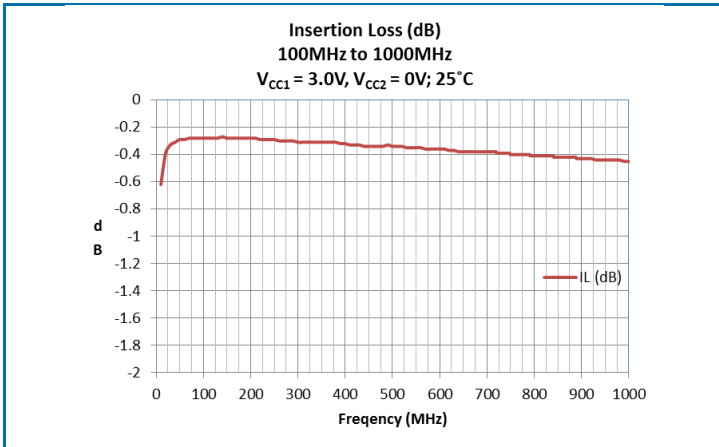

Performance Plots: 1000MHz to 4500MHz

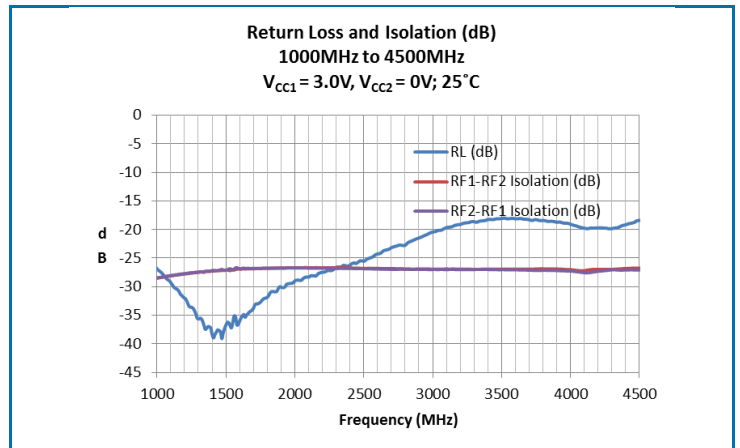
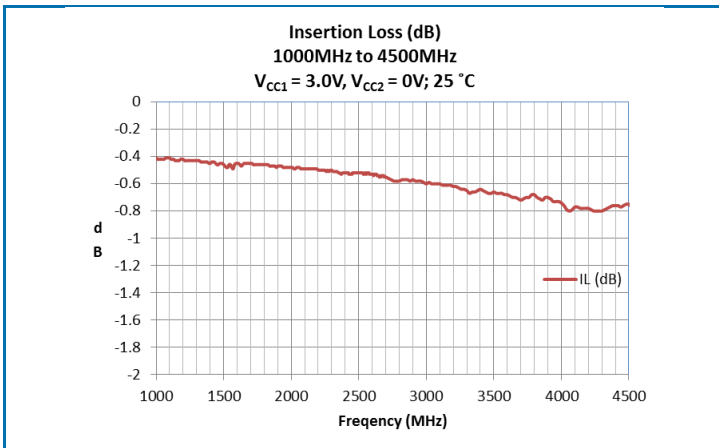

Performance Plots: 4500MHz to 6500MHz

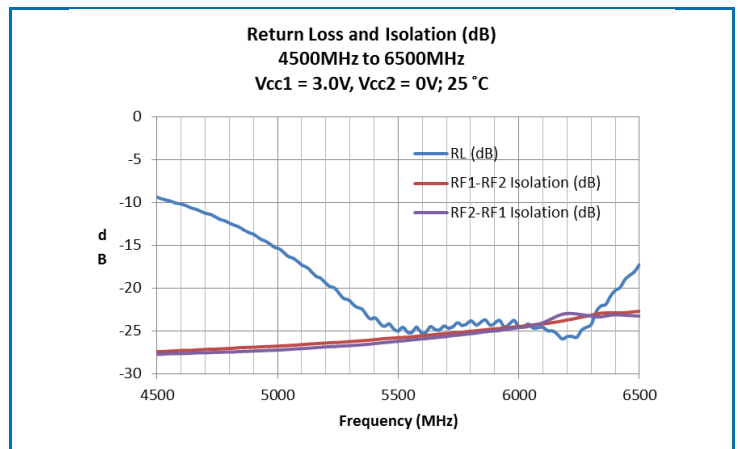
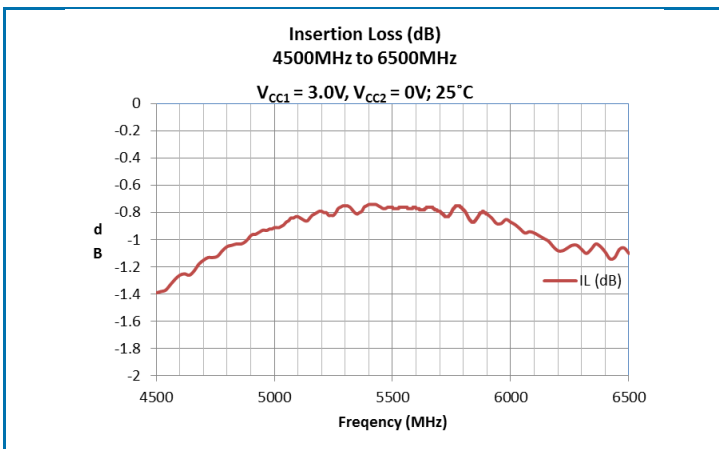

Evaluation Board Layout

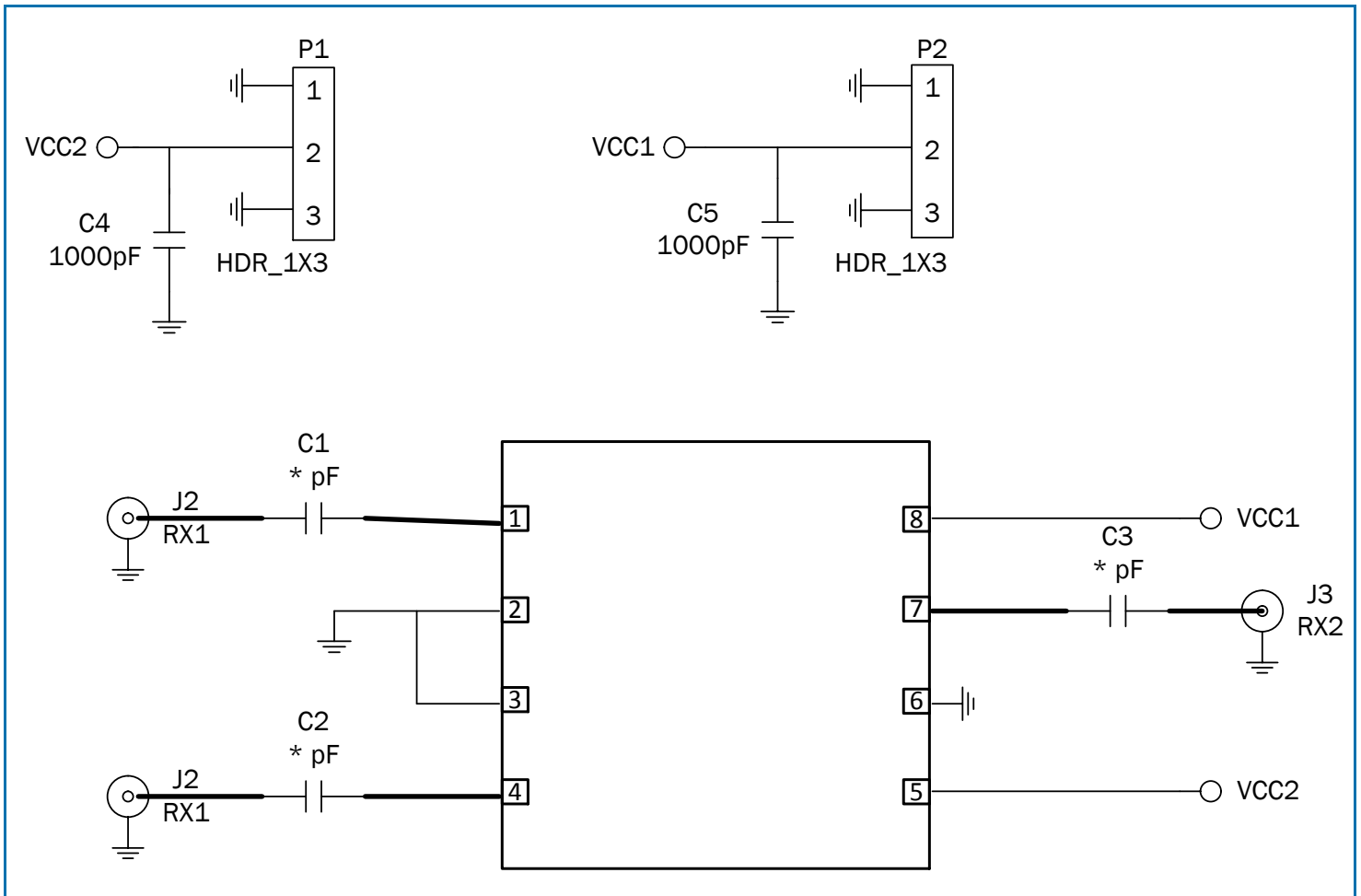

DC Block Values

Tune Band	Frequency Range	C1	C2
RFSW8000-410	100 MHz to 2000 MHz	1.0 nF	1.0 nF
RFSW8000-411	2000 MHz to 4500 MHz	33 pF	33 pF
RFSW8000-412	4500 MHz to 6500 MHz	2.0 pF	2.0 pF

Pin Out

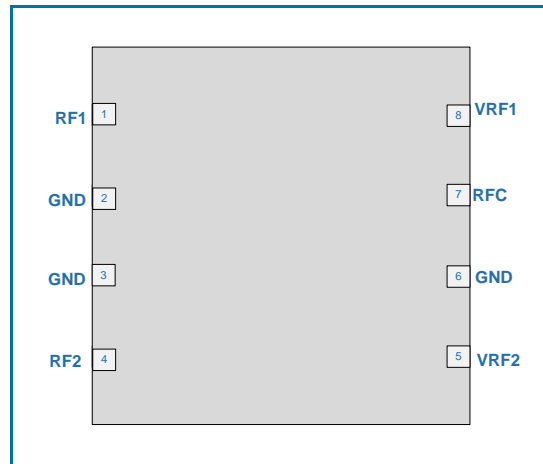

Package Drawing (dimensions in mm)

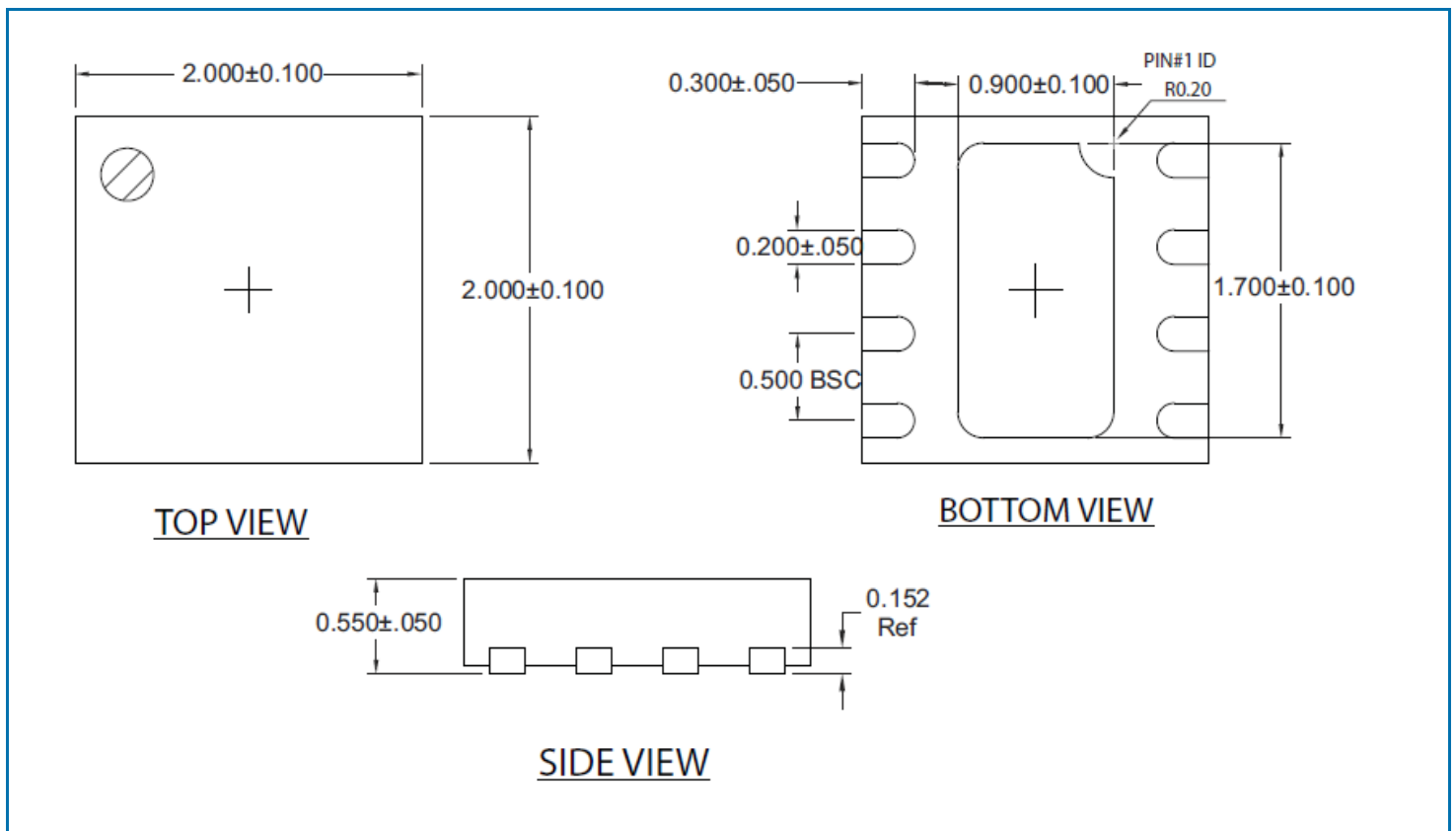

PCB Design Requirements

