

# RK10J With Knob Type

Low-profile type compatible with reflow soldering

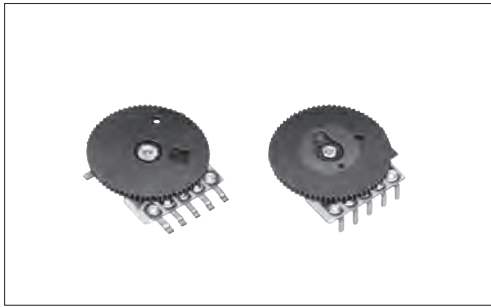

## Typical Specifications



Items	Specifications
Total resistance tolerance	±30%
Maximum operating voltage	50V AC, 20V DC (Single-unit only)
Total rotational angle	270° ± 10°
Rotational torque	0.5 to 10mN·m
Operating life	10,000 cycles
Operating temperature range	-10°C to +60°C

Rotary Potentiometers  
Slide Potentiometers

Metal Shaft

Insulated Shaft

Knob Operating

Through Shaft Type

Ring Type

## Product Line

Number of resistor elements	Mounting method	Mounting type	Knob type	Total resistance (k Ω)	Resistance taper	For DC use	Minimum order unit (pcs.)		Products No.	Drawing No.	
							Japan	Export			
Single-unit	Manual	Insertion (2mm)	Knob diameter : φ 14 Knob thickness : t0.9 Color : Black	10	1B	20V DC	3,000	2,400	RK10J11E0034	1	
Dual-unit					15A	Not applicable					RK10J12E0A0A
Single-unit	Reflow	Surface mounting	Knob diameter : φ 14 Knob thickness : t1.0 Color : Black		1B	20V DC		3,000	3,000	RK10J11R0A0L	2
Dual-unit					15A	Not applicable					

**Notes** Other varieties are also available. Refer to "Other Specifications" (P.338, 339).

## Packing Specifications

Bulk / Taping

Mounting method	Packing specifications	Number of packages (pcs.)			Tape width (mm)	Export package measurements (mm)
		1 reel	1 case /Japan	1 case /export packing		
Manual	Bulk	—	3,000	2,400	—	371×250×190
Reflow	Taping	1,000	3,000	3,000	24	401×397×139

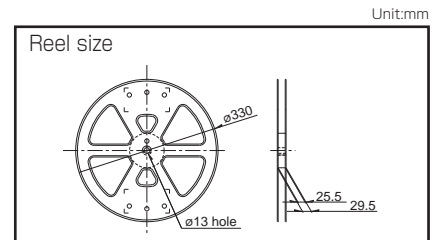

## Dimensions

No.	Photo	Style	PC board mounting hole dimensions (Viewed from mounting side)
1	<p><b>RK10J1 □ E Manual</b></p>		

Refer to P.338 for other specifications.  
Refer to P.340 for ordering products not listed.  
Refer to P.341 for soldering conditions.

# RK10J With Knob Type

## Dimensions

Unit:mm

No.	Photo	Style	PC board mounting hole dimensions (Viewed from mounting side)
2	<p><b>RK10J1 □ R Reflow</b></p>		<p>Center of knob</p> <p>Shaded area: Solder land</p>

## Circuit Diagram

Single-unit	Dual-unit	Dual-unit resistance taper 15C

## With Knob Type / Other Specifications

In addition to the Product Line, we accommodate the following specifications. Combinations not included in the Product Line are treated as semi-standard products.

### Total Resistance Variety

Total resistance (k Ω)	10	20	50	100

### Resistance Taper

Resistance taper	15A	1B	3B	15C

### Terminal Layout

	Resistance taper A or B		Resistance taper C	
	Single-unit	Dual-unit	Single-unit	Dual-unit
<b>10mm Single-unit/ Dual-unit RK10J1 □ E (Manual)</b>				
<b>10mm Single-unit/ Dual-unit RK10J1 □ R (Reflow)</b>				

Refer to P.340 for ordering products not listed.

# With Knob Type / Other Specifications

In addition to the Product Line, we accommodate the following specifications. Combinations not included in the Product Line are treated as semi-standard products.

## ■ Mounting Plate Types and Terminal Types

RK10J1 □ E (Manual)		Unit:mm
Terminal length : 2.0	Terminal length : 2.8	

## ■ Knob Variety

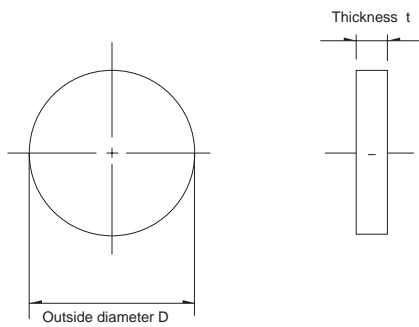

Applicable models	Knob variety			Body thickness (mm)
	Type	Outer diameter D	Thickness (mm)	
<b>RK10J11E</b> <b>RK10J12E</b> <b>(Manual)</b>	K4	$\phi 14$	0.9	Black
	K5	$\phi 16$	3.0	
<b>RK10J11R</b> <b>RK10J12R</b> <b>(Reflow)</b>	K1	$\phi 14$	1.0	Black
	K2	$\phi 14$	2.5	
	K3	$\phi 16$		

### Note

Marked are specifications recommended by Alps Alpine.

Rotary  
Potentiometers

Slide  
Potentiometers

Metal Shaft

Insulated  
Shaft

Knob  
Operating

Through  
Shaft Type

Ring Type

# With Knob Type / Ordering Products Not Listed

In addition to the Product Line, we accommodate the following specifications. Combinations not included in the Product Line are treated as semi-standard products. Please refer to the notation example below.

## Sample Part Number

**R K 1 0 J 1 1 R** — **K 1** — **B 2 0 3**

### Model type

Code	Model type
RK10J11E	10mm size single-unit Manual
RK10J12E	10mm size dual-unit Manual
RK10J11R	10mm size single-unit Reflow
RK10J12R	10mm size dual-unit Reflow

### Shaft type (Outer diameter/Thickness) (mm)

Code	RK10J1□E	RK10J1□R
K1	—	V14 t1.0
K2	—	V14 t2.5
K3	—	V16 t2.5
K4	V14 t0.9	—
K5	V16 t3.0	—

\*Color : Black

### Resistance taper

Code	Resistance taper	Code	Resistance taper
A	15A	C	15C
B	1B	V	3B

B: For tone & general  
V: For vol.

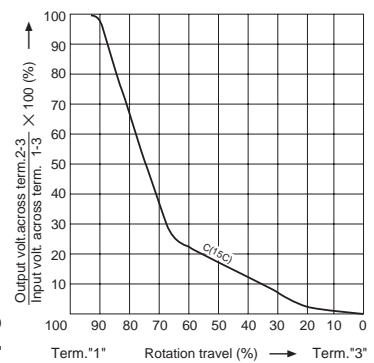
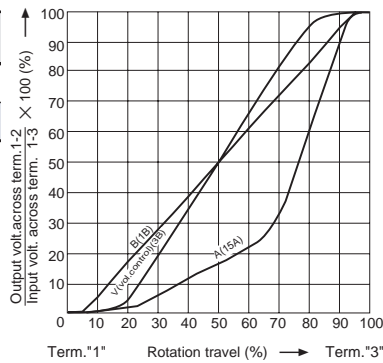

### Total resistance

Code	Total resistance (k Ω)	Code	Total resistance (k Ω)
103	10	503	50
203	20	104	100

### Note

Marked are specifications recommended by Alps Alpine.

Rotary Potentiometers

Slide Potentiometers

Metal Shaft

Insulated Shaft







Knob Operating

Through Shaft Type

Ring Type

# Knob Operating Type Potentiometers

## List of Varieties

Type		Without knob type		With knob type	
Series		RK08H1 □ 1	RK08H1 □ 3	RK10J1 □ E	RK10J1 □ R
		Single-unit/Dual-unit	Single-unit/Dual-unit	Single-unit/Dual-unit	Single-unit/Dual-unit
Photo					
Terminal orientation		Vertical	Reflow type	—	—
Operating temperature range		-10°C to +60°C			
Operating life		Without detent 10,000 cycles With detent 5,000 cycles		10,000 cycles	
Automotive use		—	—	—	—
Life cycle					
Electrical performance	Total resistance (k Ω)	5, 10, 20, 50, 100		10, 20, 50, 100	
	Resistance taper	15A, 1B, 3B, 15C			
	Rated power	0.03W			
	Insulation resistance	—	—	100MΩ min. 100V DC	
	Voltage proof	—	—	100V AC for 1minute	
Mechanical performance	Detent	Without / Center detent		Without	
	Stopper strength	0.1N		70mN·m	
	Push-pull strength	10N		5N	
Terminal style		Insertion	Reflow	Insertion	Reflow
Page		333		337	

### Residual Resistance

※ Applies only to products with specified residual resistance

Nominal total resistance	※ Residual resistance
100kΩ ≥ R ≥ 50kΩ	0.1% or less of nominal total resistance
50kΩ > R > 10kΩ	30Ω or less
10kΩ ≥ R	20Ω or less

### Maximum Attenuation

Nominal total resistance	Maximum attenuation
R ≥ 100kΩ	90dB min.
100kΩ > R ≥ 50kΩ	80dB min.
50kΩ > R ≥ 10kΩ	70dB min.
10kΩ > R	60dB min.

Knob Operating Type Potentiometers Soldering Conditions	341
Potentiometers Cautions	384
Potentiometers Measurement and Test Methods	386
Potentiometers Resistance Taper	388