

SILICON RECTIFIER

VOLTAGE RANGE 1000 to 1800 Volts CURRENT 1.0 Ampere

FEATURES

- * High reliability
- * Low leakage current
- * Low forward voltage drop
- * High current capability

MECHANICAL DATA

- * Case : Molded plastic
- * Epoxy : Device has UL flammability classification 94V-0
- * Lead : MIL-STD-202E method 208C guaranteed
- * Mounting position : Any
- * Weight : 0.20 gram



A-405

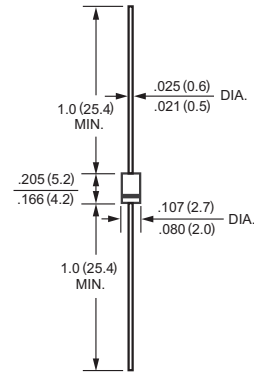

Dimensions in inches and (millimeters)

MAXIMUM RATINGS AND ELECTRICAL CHARACTERISTICS

Ratings at 25 °C ambient temperature unless otherwise specified.
Single phase, half wave, 60 Hz, resistive or inductive load.
For capacitive load, derate current by 20%.

MAXIMUM RATINGS (@ TA=25 °C unless otherwise noted)

RATINGS	SYMBOL	RL1N1000F	RL1N1200F	RL1N1400F	RL1N1600F	RL1N1800F	UNITS
Maximum Recurrent Peak Reverse Voltage	V _{RRM}	1000	1200	1400	1600	1800	Volts
Maximum RMS Voltage	V _{RMS}	700	840	980	1120	1260	Volts
Maximum DC Blocking Voltage	V _{DC}	1000	1200	1400	1600	1800	Volts
Maximum Average Forward Rectified Current at TA=55°C	I _O	1.0					Amps
Peak Forward Surge Current 8.3 ms single half sine-wave superimposed on rated load (JEDEC method)	I _{FSM}	30					Amps
Typical Current Squarad Time	I ² t	3.74					A ² S
Typical Thermal Resistance	R _{θJA}	50					°C/W
Typical Junction Capacitance (Note 1)	C _J	15					pF
Operating and Storage Temperature Range	T _J ,T _{STG}	-55 to + 150					°C

ELECTRICAL CHARACTERISTICS (@TA=25 °C unless otherwise noted)

CHARACTERISTICS	SYMBOL	RL1N1000F	RL1N1200F	RL1N1400F	RL1N1600F	RL1N1800F	UNITS
Maximum Instantaneous Forward Voltage at 0.5A DC	V _F	1.8					Volts
Maximum DC Reverse Current at Rated DC Blocking Voltage	@T _A = 25 °C	5.0					μA
	@T _A = 100 °C	100					
Maximum Reverse Recovery Time (Note 4)	t _{rr}	300					nS

- NOTES : 1. Measured at 1 MHz and applied reverse voltage of 4.0 volts.
2. "ROHS compliant".
3. Available in Halogen-free epoxy by adding suffix -HF after the part nbr.
4. Test Conditions: I_F= 0.5A, I_R= -1.0A, I_{RR}= -0.25A.

RATING AND CHARACTERISTIC CURVES (RL1N1000F THRU RL1N1800F)

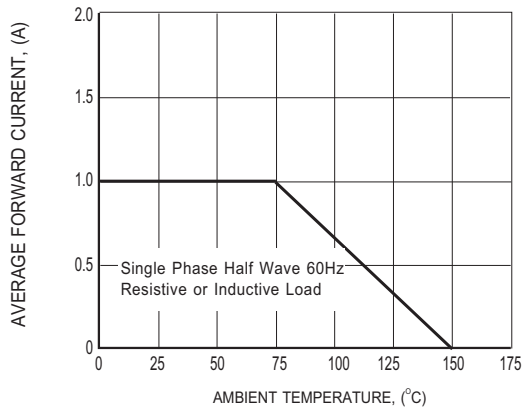

FIG.1 TYPICAL FORWARD CURRENT DERATING CURVE

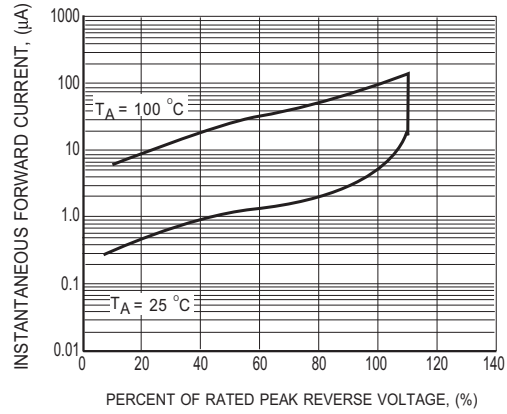

FIG.2 MAXIMUM REVERSE CHARACTERISTICS

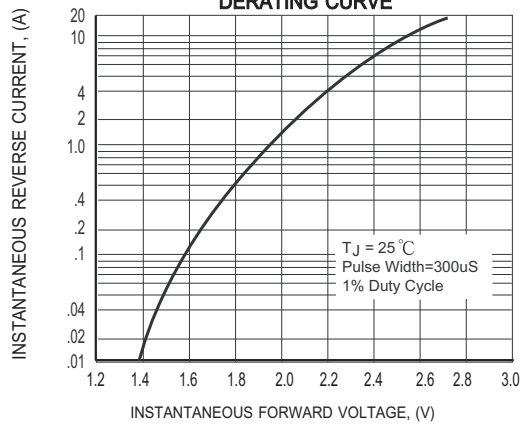

FIG.3 MAXIMUM INSTANTANEOUS FORWARD CHARACTERISTICS

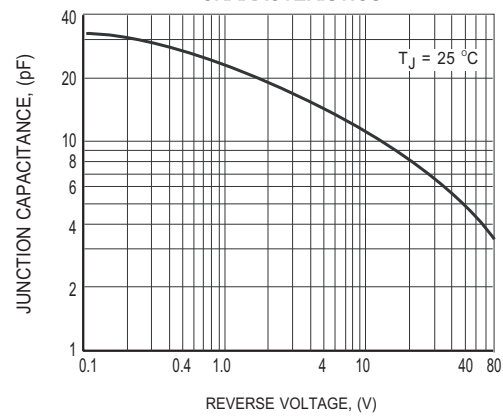

FIG.4 TYPICAL JUNCTION CAPACITANCE

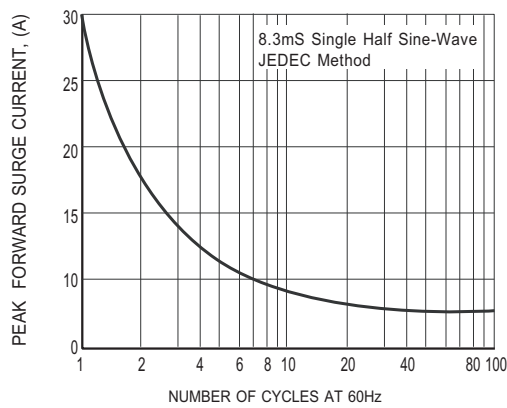
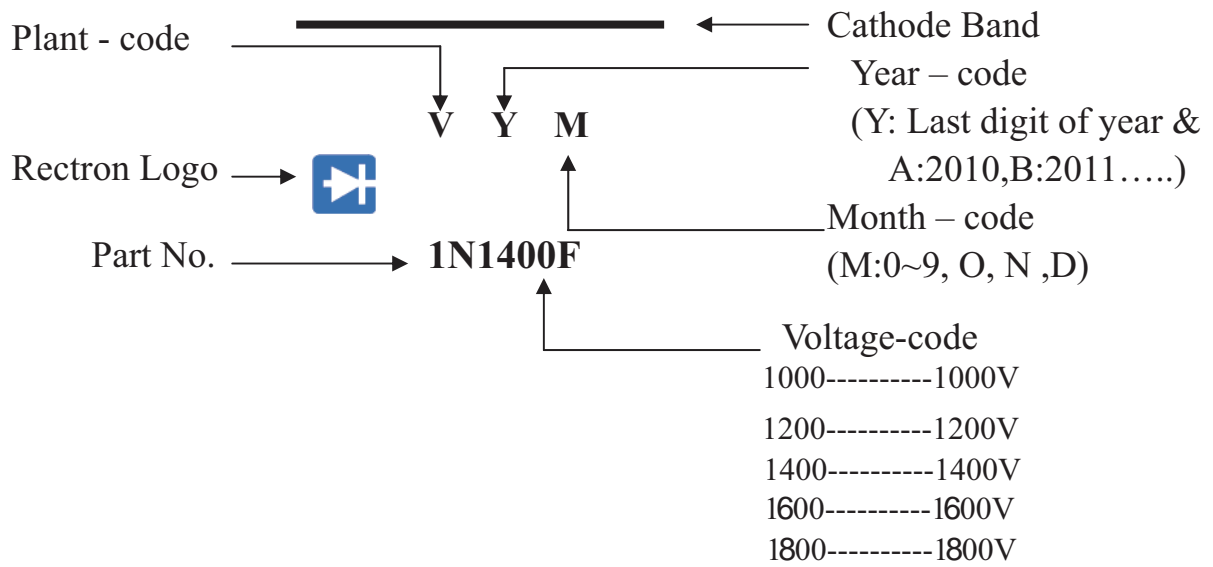

FIG.5 MAXIMUM NON-REPETITIVE FORWARD SURGE CURRENT

Mark Description



PACKAGING OF DIODE AND BRIDGE RECTIFIERS

BULK PACK

PACKAGE	PACKING CODE	EA PER BOX	INNER BOX SIZE (mm)	CARTON SIZE (mm)	EA PER CARTON	GROSS WEIGHT(Kg)
A-405	-B	1,000	194*84*21	415*220*255	50,000	15.64

REEL PACK

PACKAGE	PACKING CODE	EA PER REEL	EA PER INNER BOX	COMPONENT SPACE (mm)	TAPE SPACE (mm)	REEL DIA (mm)	CARTON SIZE (mm)	EA PER CARTON	GROSS WEIGHT(Kg)
DO-41	-T	5,000	5,000	5.0	52	330	355*350*335	20,000	8.13

AMMO PACK

PACKAGE	PACKING CODE	REEL (EA)	COMPONENT SPACE(mm)	TAPE SPACE (mm)	BOX SIZE (mm)	CARTON SIZE(mm)	CARTON (EA)	GROSS WEIGHT (Kg)
DO-41	-F	3,000	5.0	52	255*73*100	400*268*225	30,000	9.6
DO-41	-E	3,000	5.0	26	256*48*94	365*270*217	42,000	9.61
A-405	-N	2,000	12.7	---	325*170*40	355*350*335	28,000	11.41

