

CATALOG NO.	TERMINAL TYPE	IP20 FINGER SAFE COVERS		NO. OF POLES
		W/O INDICATION	INDICATION	
RM60060-1CR*	BOX LUG 1 PORT			1
RM60060-2CR*	BOX LUG 1 PORT			2
RM60060-3CR*	BOX LUG 1 PORT			3
RM60060-1MW14	BOX LUG - 1 TO 4 PORT			1
RM60060-2MW14	BOX LUG - 1 TO 4 PORT			2
RM60060-3MW14	BOX LUG - 1 TO 4 PORT			3
RM60060-1MW12	BOX LUG - 1 TO 2 PORT	CVR-RH-60060	CVRI-RH-60060	1
RM60060-2MW12	BOX LUG - 1 TO 2 PORT			2
RM60060-3MW12	BOX LUG - 1 TO 2 PORT			3
RM60060-1MW24	BOX LUG - 2 TO 4 PORT			1
RM60060-2MW24	BOX LUG - 2 TO 4 PORT			2
RM60060-3MW24	BOX LUG - 2 TO 4 PORT			3

* -CHR ALSO AVAILABLE; SEE NOTE 10

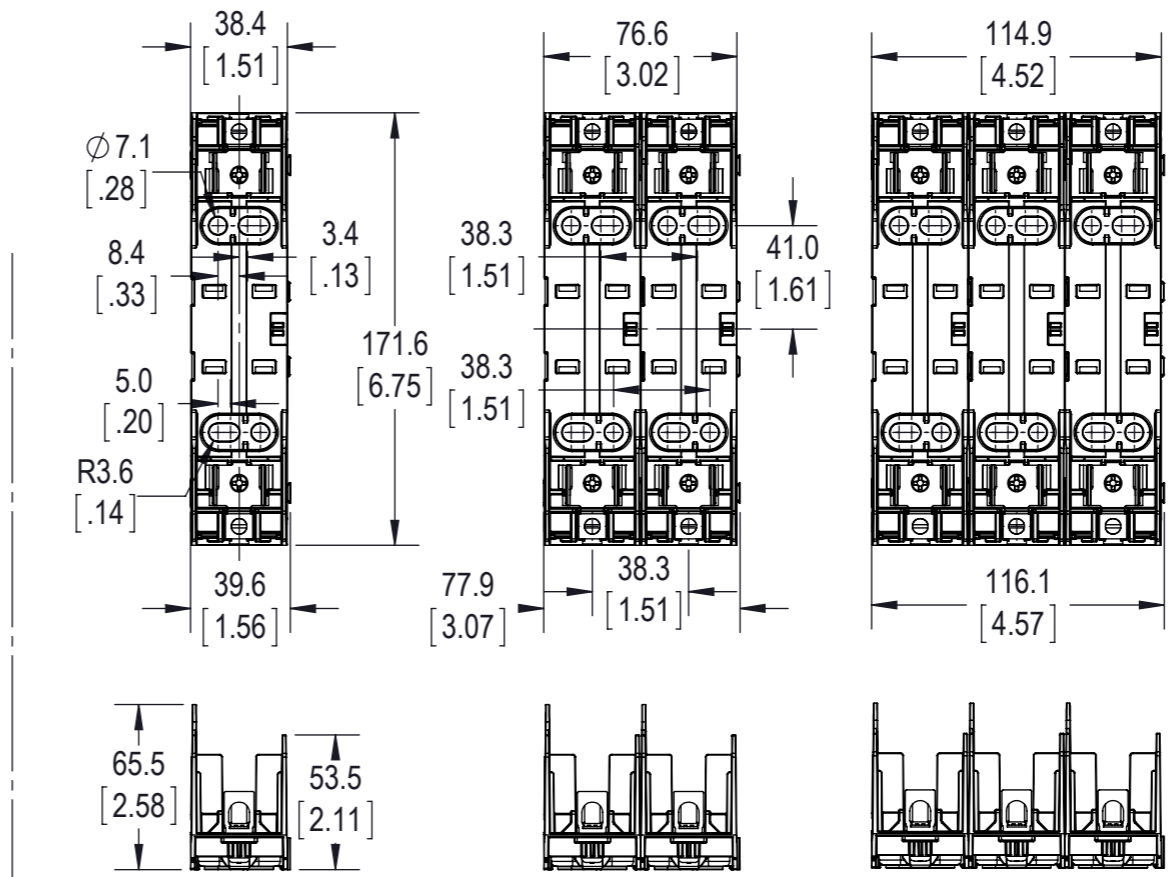

1-POLE RM60060-1CR SHOWN 2-POLE RM60060-2CR SHOWN 3-POLE RM60060-3CR SHOWN RM60060-1CR SHOWN WITH COVER

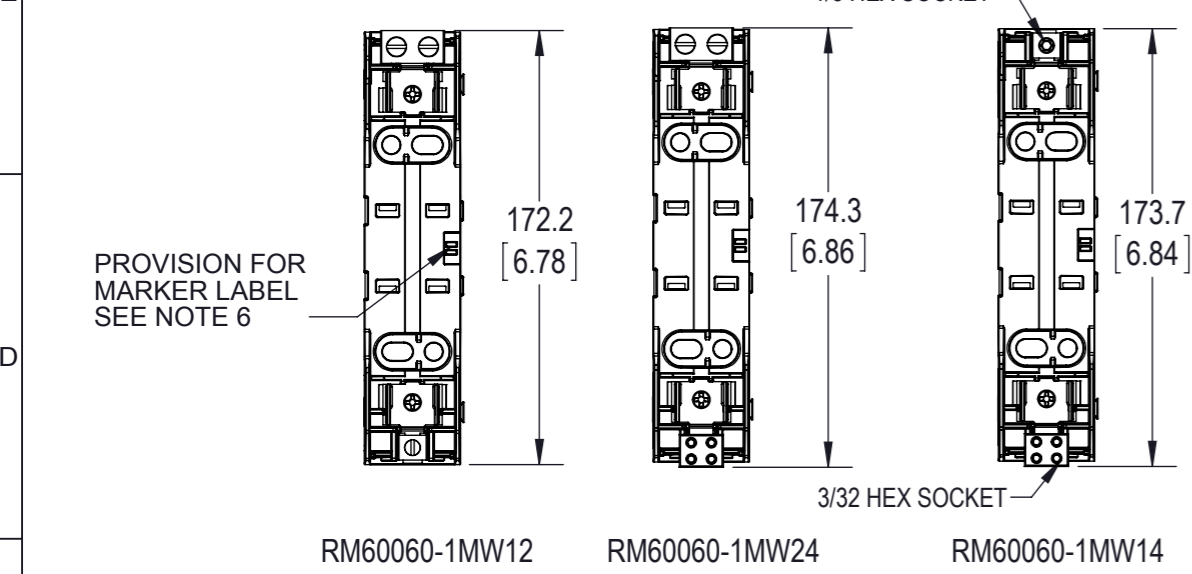
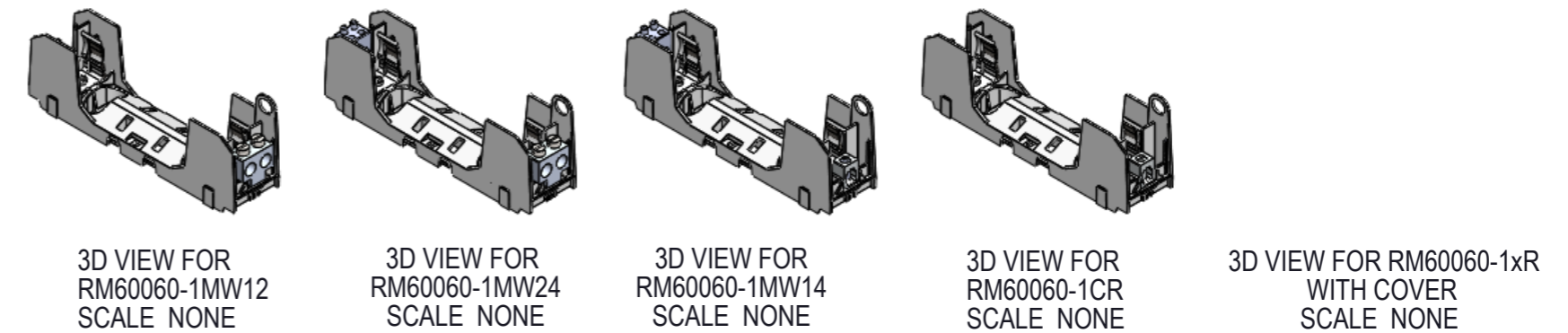
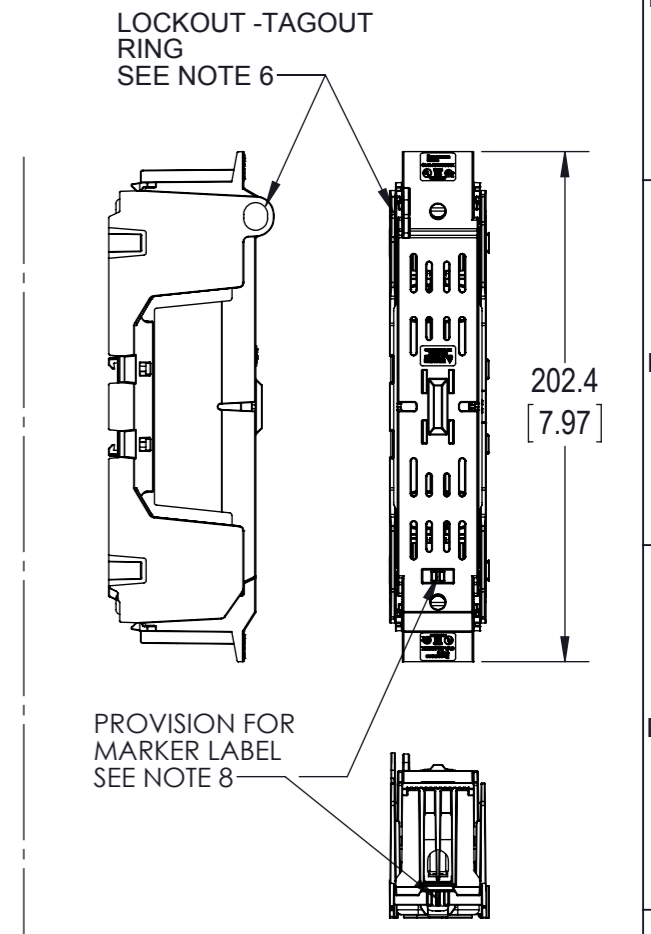

- NOTES:
- VOLTAGE RATING: 600V
 - AMPERAGE: 60A
 - WITHSTAND RATING: CLASS R = 200kA; CLASS H = 10kA
 - WIRE: -CR/-MW12/MW14 CU/AL 75C
-MW24 CU/AL 75/90C
 - 1 PORT WIRE RANGE: (1) 2 - 14 AWG CU
2-3: 50 lb-in (5.6 Nm)
4-6, 45 lb-in (5.1 Nm)
8, 40 lb-in (4.5 Nm)
10-14, 35 lb-in (4.0 Nm)
(2) 12-14, 50 lb-in (5.6 Nm)
(1) 2 - 8 AWG AL
2-3: 50 lb-in (5.6 Nm)
4-6, 45 lb-in (5.1 Nm)
8, 40 lb-in (4.5 Nm)
 - 4 PORT WIRE RANGE: (1) 8-14 AWG CU
8 AWG 3.4 Nm (30 in-lb)
14-10 2.8 Nm (25 in-lb)
(2) 12-14 AWG CU
12-14 3.4 Nm (30 in-lb)
(1) 8-10 AWG AL
8 Str/10 Sol: 3.4 Nm (30 in-lb)
 - 2 PORT WIRE RANGE: (1) CU 2-14, AL 2-8
2 - 4 AWG 5.6 Nm (50 lb-in)
6-10 AWG 4.5 Nm (40 lb-in)
12-14 AWG 1.7 Nm (15 lb-in)
 - USE 4MM DIA. CABLE LOCK OR 1/4 INCH DIA. HASP PADLOCK.
 - RECOMMEND USING DIN-RAIL END STOPS FOR DIN RAIL MOUNTED APPLICATIONS
BUSSMANN PART NUMBERS BRKT-ND OR BRKT-NDSCREW2
 - USE BUSSMANN MAKER LABEL TM26CB
 - ALL DIMENSIONS ARE TYPICAL UNLESS OTHERWISE INDICATED
 - CHR IS IDENTICAL TO THE -CR EXCEPT WITH A 1/8 INCH HEX WIRE CONNECTOR SCREW

EATON CORPORATION - CONFIDENTIAL AND PROPRIETARY
NOTICE TO PERSONS RECEIVING THIS DOCUMENT AND/OR TECHNICAL INFORMATION

THIS DRAWING IS AN UNCONTROLLED COPY IF PRINTED OR SENT ELECTRONICALLY. DO NOT SCALE DRAWING

GENERAL DRAWING PRACTICES IN ACCORDANCE WITH ASME - Y14.100-2004 DIMENSIONS AND TOLERANCES IN ACCORDANCE WITH ASME - Y14.5M-1994 UNLESS OTHERWISE SPECIFIED DIMENSIONS ARE IN MILLIMETERS

UNLESS OTHERWISE SPECIFIED TOLERANCES TO BE MILLIMETERS ± 0.13 mm ANGULAR ± 1°

EATON BUSSMANN SERIES

TITLE: **600V / 60AMP CLASS R & H FUSE BLOCK**

SIZE: **A3** DWG NO.: **RM60060-HM60060-CP** REV: **B**

SCALE: 1:3 SHEET 1 OF 3

CUSTOMER PRINT
THIRD ANGLE PROJECTION

© 2012 Eaton Corporation. All Rights Reserved.

CATALOG NO.	TERMINAL TYPE	IP20 FINGER SAFE COVERS		NO. OF POLES
		W/O INDICATION	INDICATION	
HM60060-1CR*	BOX LUG 1 PORT	CVR-RH-60060	CVRI-RH-60060	1
HM60060-2CR*	BOX LUG 1 PORT			2
HM60060-3CR*	BOX LUG 1 PORT			3
HM60060-1MW14	BOX LUG - 1 TO 4 PORT			1
HM60060-2MW14	BOX LUG - 1 TO 4 PORT			2
HM60060-3MW14	BOX LUG - 1 TO 4 PORT			3
HM60060-1MW12	BOX LUG - 1 TO 2 PORT			1
HM60060-2MW12	BOX LUG - 1 TO 2 PORT			2
HM60060-3MW12	BOX LUG - 1 TO 2 PORT			3
HM60060-1MW24	BOX LUG - 2 TO 4 PORT			1
HM60060-2MW24	BOX LUG - 2 TO 4 PORT			2
HM60060-3MW24	BOX LUG - 2 TO 4 PORT			3

* -CHR ALSO AVAILABLE; SEE NOTE 10

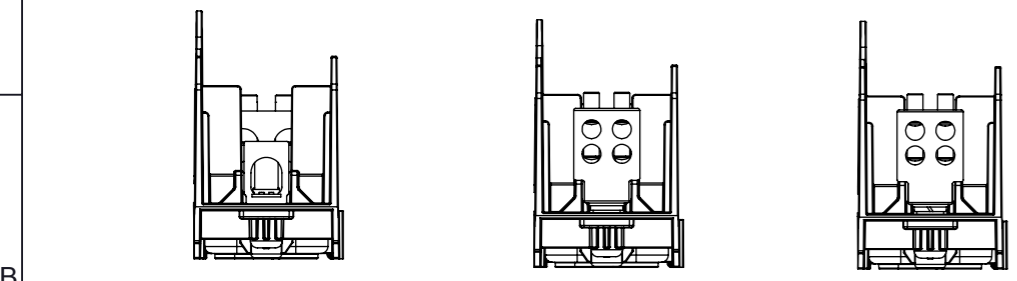
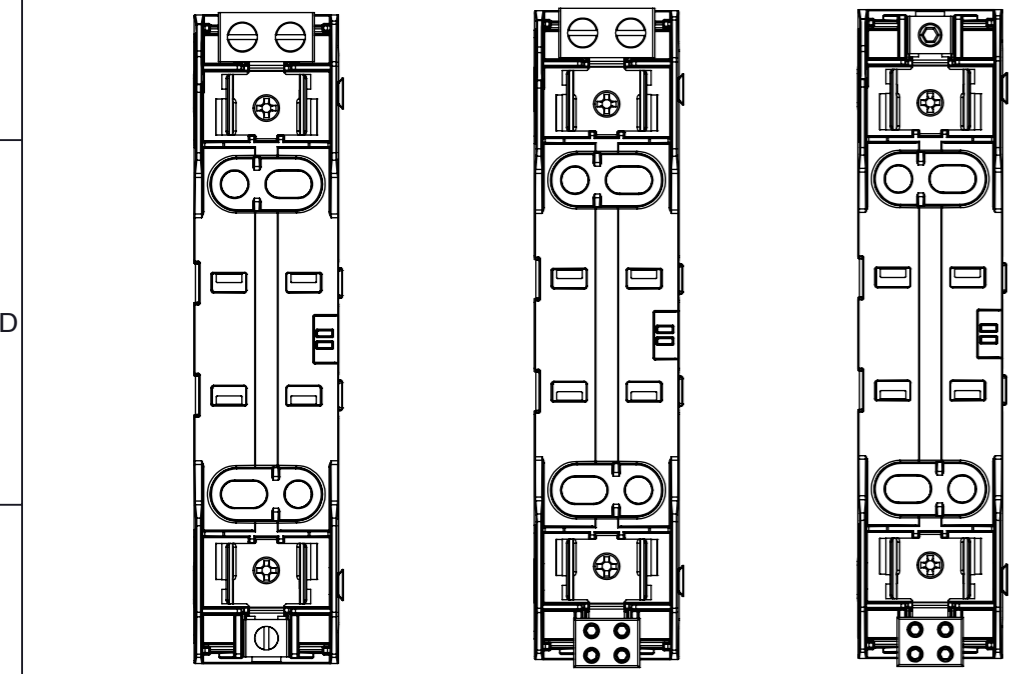

HM60060-1MW12 HM60060-1MW24 HM60060-1MW14

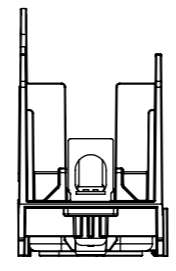
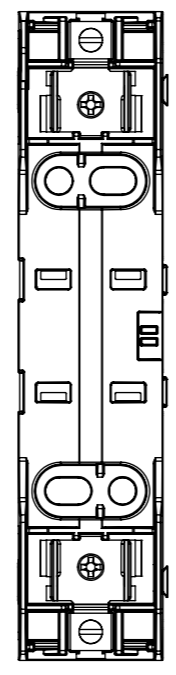

1-POLE
HM60060-1CR SHOWN

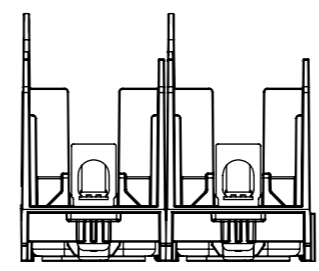
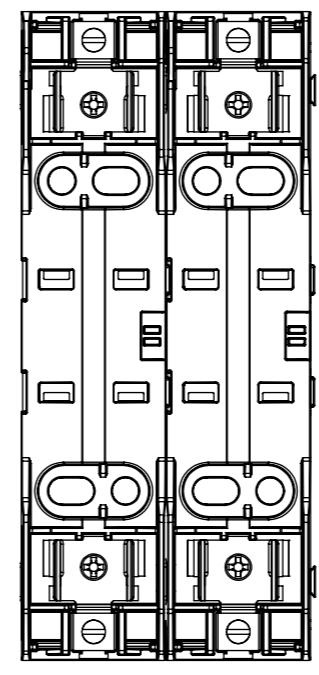

2-POLE
HM60060-2CR SHOWN

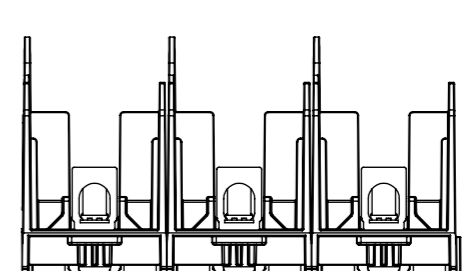
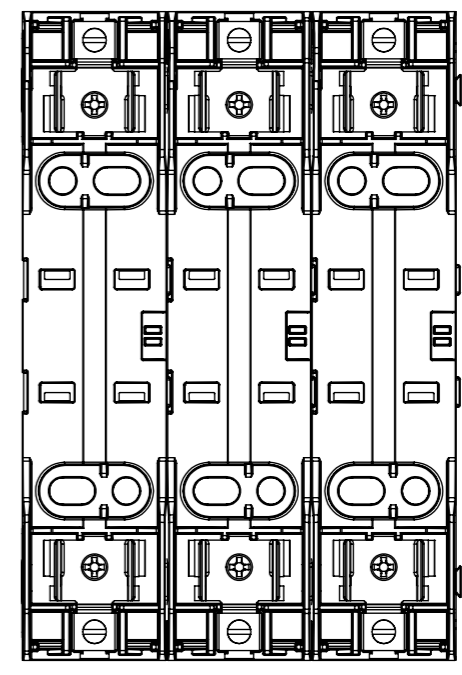

3-POLE
HM60060-3CR SHOWN

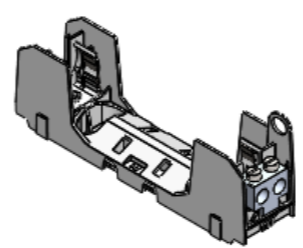

3D VIEW FOR
HM600060-1MW12
SCALE NONE

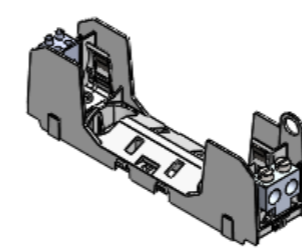

3D VIEW FOR
HM60060-1MW24
SCALE NONE

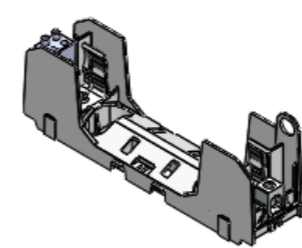

3D VIEW FOR
HM60060-1MW14
SCALE NONE

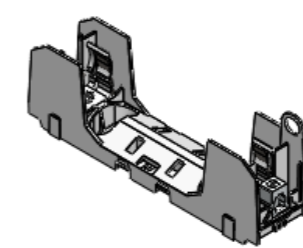

3D VIEW FOR
HM60060-1CR
SCALE NONE

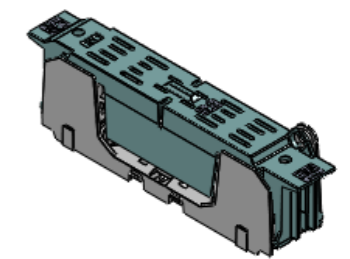

3D VIEW FOR HM60060-1xR
WITH COVER
SCALE NONE

EATON BUSSMANN SERIES

TITLE: **600V / 60AMP CLASS R & H FUSE BLOCK**

SIZE: **A3** DWG NO.: **RM60060-HM60060-CP** REV: **B**

SCALE: 1:2 SHEET 2 OF 3

8.A3_BUSS_M60_CERBL_REV_A