

RP-RM83F Heavy-Duty Rope Pull Emergency Stop Switch



Datasheet

Rope pull switch with an emergency stop button for indoor or outdoor use



- Both safety contacts latch open when rope is pulled, broken, or if tension is reduced; requires manual reset (IEC 60947-5-5)
- Aluminum die-cast housing, rated IP67 and NEMA 4, suitable for demanding indoor and outdoor industrial environments
- Innovative RP-RM83F-..LT.. design provides quick, easy rope adjustment
- Rope spans up to 75 m (245 ft), depending on model
- Both safety contacts are closed with normal rope tension, and open when rope is pulled or if rope breaks (or if tension is reduced from normal amount)
- Both Monitoring contacts operate opposite the safety contacts for monitoring by another device
- Additional Aux. 24 V solid-state PNP output on some models provides remote rope tension monitoring
- Tension indicator window indicates proper rope tension for operation or safety contacts latched open (the rope pull or the E-stop button is actuated)

Models

Model	Max. Rope Length	Rope Connection	Aux. Status Output	Run Position	Cable Pulled/ Cable Break	Switching Diagram
RP-RM83F-75LTE	75 m (245 ft)	Built-in Turnbuckle	Yes	Cable Run Position (All Models)		
RP-RM83F-75LRE		Ring		S1	S2	
RP-RM83F-75LT		Built-in Turnbuckle	No			
RP-RM83F-75LR		Ring		S1	S2	
RP-RM83F-38LTE	37.5 m (123 ft)	Built-in Turnbuckle	Yes	Cable Pulled / Cable Break Position (All Models)		
RP-RM83F-38LRE		Ring		S1	S2	
RP-RM83F-38LT		Built-in Turnbuckle	No			
RP-RM83F-38LR		Ring		S1	S2	

Contacts: Open Closed



Note: This symbol for a positive-opening safety contact (IEC 60947-5-1) is used in the switching diagram to identify the point in actuator travel where the normally-closed safety contact is fully open.

Important... Read This First

Regarding the Use of Rope Pull Switches. In the United States, the functions that Banner rope pull switches are intended to perform are regulated by the Occupational Safety and Health Administration (OSHA). Whether or not any particular rope pull switch installation meets all applicable OSHA requirements depends upon factors that are beyond the control of Banner Engineering Corp. These factors include the details of how the switches are applied, installed, operated, and maintained.

Banner Engineering Corp. has attempted to provide complete application, installation, operation, and maintenance instructions in this document. Direct any questions regarding the use or installation of rope pull switches to the factory applications department.



Banner Engineering Corp. recommends that rope pull switches be applied according to the guidelines set forth in the standards listed below. In addition, the user is responsible for ensuring all local, state, and national laws, rules, codes, and regulations relating to the use of Banner rope pull switches in each application are satisfied. Extreme care is urged that all legal requirements are met and that all installation and maintenance instructions are followed.

Applicable U.S. and International Standards (not all inclusive):

- ANSI B11.0 Safety of Machinery, General Requirements, and Risk Assessment
Contact: Safety Director, AMT – The Association for Manufacturing Technology, 7901 Jones Branch Drive, Suite 900, McLean, VA 22102-4206 USA, www.amtonline.org
- ANSI B11.19 Performance Criteria for Safeguarding
Contact: Safety Director, AMT – The Association for Manufacturing Technology, 7901 Jones Branch Drive, Suite 900, McLean, VA 22102-4206 USA, www.amtonline.org
- NFPA 79 Electrical Standard for Industrial Machinery
Contact: National Fire Protection Association, 1 Batterymarch Park, Quincy, MA 02169-7471 USA, www.nfpa.org/
- ANSI/RIA R15.06 Safety Requirements for Industrial Robots and Robot Systems
Contact: Robotic Industries Association, 900 Victors Way, Suite 140, Ann Arbor, MI 48108 USA, www.robotics.org
- EN ISO 12100 Safety of Machinery – General Principles for Design — Risk Assessment and Risk Reduction
- EN 60204-1 Electrical Equipment of Machines Part 1: General Requirements
- ISO 13850 (EN 418) Emergency Stop Devices, Functional Aspects – Principles for Design
- IEC 60947-5-5 Low Voltage Switchgear – Electrical Emergency Stop Device with Mechanical Latching Function

These and other standards are available from:

- NSSN National Resource for Global Standards:** www.nssn.org (Tel: 212-642-4980)
- IHS Standards Store:** www.global.ihs.com (Tel: 303-397-7956, 800-854-7179)
- Document Center:** www.document-center.com/home.cfm (Tel: 650-591-7600)

Overview

Models RP-RM83F-.. are rope pull emergency stop switches in compact, heavy-duty die-cast aluminum housings, for indoor or outdoor use. When used with steel wire rope, they can provide emergency stop actuation along conveyors and similar machinery. Red PVC-covered 2, 3, 4, or 5 mm diameter wire rope is recommended, depending on model (force) and rope distance.

The switches have redundant contacts; terminals 11/12 are positive opening when there is a cable-pull or cable-brake situation. When used separately, these contacts provide inputs to a dual-channel safety module. Terminals 11/12 can also be used individually to provide single-channel switching or as a single-channel input to a safety module. Terminals 23/24 are for monitoring purposes only (closed in a cable-break/cable-pull situation).

When the rope is properly tensioned (228 or 133N, depending on model), the red arrows are centered under the hash mark on the tension indicator window, the contacts at terminals 11/12 are closed, and the contacts at terminals 23/24 are open. All models feature a “latching” operation. When the rope is pulled, the switch contacts 11/12 open and remain open until the built-in E-stop/reset button is manually reset.

These rope pull emergency stop switches are not generally considered safeguarding devices, in that they do not prevent or reduce exposure of individuals to a hazard. They provide the same function as other types of emergency stop switches.



WARNING:

- **Not a safeguarding device**
- Failure to follow these instructions could result in serious injury or death.
- This device is not considered a safeguarding device because it requires an overt action by an individual to stop machine motion or hazards. A safeguarding device limits or eliminates an individual's exposure to a hazard without action by the individual or others. This device cannot be substituted for required safeguarding. Refer to the applicable standards to determine those requirements.



WARNING:

- **Do not mute or bypass any emergency stop device**
- Muting or bypassing the safety outputs renders the emergency stop function ineffective.
- ANSI B11.19, NFPA 79 and IEC/EN 60204-1 require that the emergency stop function remains active at all times.

Figure 1. Run Condition (Proper Rope Tension) - Contacts 11/12 Closed

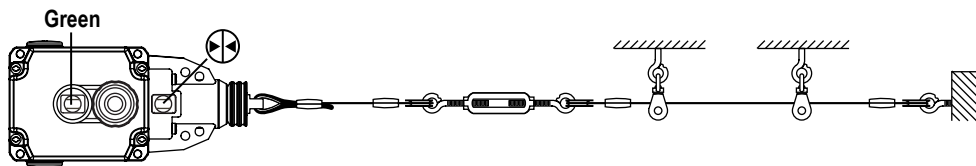

Figure 2. Rope Pulled Condition - Contacts 11/12 Open

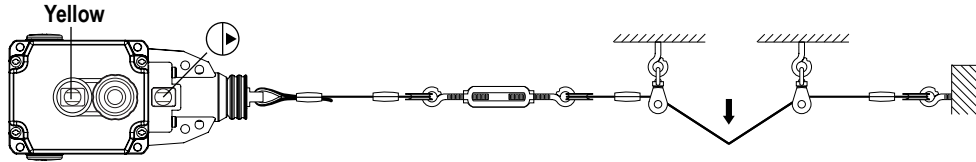
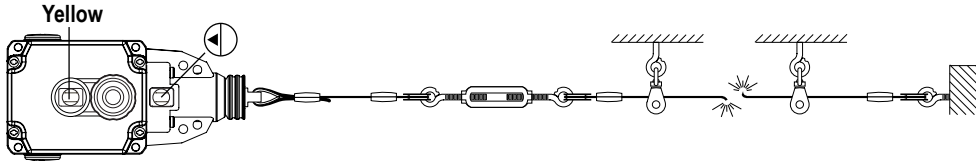

Figure 3. Rope Break Condition - Contacts 11/12 Open



Mechanical Installation

- The rope should be easily accessible and visible along its entire length. Markers or flags may be fixed on the rope to increase its visibility
- Switch body, anchor mounts and wire rope supports (pulleys or eye bolts) must be rigid and secure
- Although pulleys are preferred, a combination of pulleys and/or eye bolts are required to support the wire rope along its length. When pulled, the wire rope, should move freely through the pulleys or eye bolts to actuate the switch
- Use only pulleys (not eye bolts) when routing the rope around a corner or whenever direction changes, even slightly
- Never run rope through conduit or other tubing
- Never attach weights to the rope
- Temperature affects rope tension. The rope expands (lengthens) when temperature increases, and contracts (shrinks) when temperature decreases. Significant temperature variations require frequent checks of the tension adjustment
- Do not exceed the maximum specified total rope length. Banner offers models for other spans; contact Banner Engineering or visit www.bannerengineering.com for model selection



WARNING:

- Failure to use pulleys or eye bolts to support the wire rope may damage the switch.
- **Damaging the switch may create a dangerous situation that could lead to serious injury or death.**
- Use pulleys or eye bolts to support the wire rope to avoid damaging the switch.



Note: A tensioning spring is required to ensure compliance with the direction-independent actuation of the wire rope.

Follow these steps to install the switch.

1. Mount the switch securely on a solid stationary surface.
2. Fasten an eye bolt at the opposite end of the rope span from the switch. Verify that the anchor for the eye bolt is solid and stationary to withstand the constant tension and possible pull of the rope.
3. Assemble the rope as shown. Keep the rope's PVC cover intact along its complete length.
4. Use pulleys (recommended) or eye bolts at each support point. Always use a pulley when routing the rope around a corner, regardless of the angle.

Figure 4. Assembly of Rope and Hardware

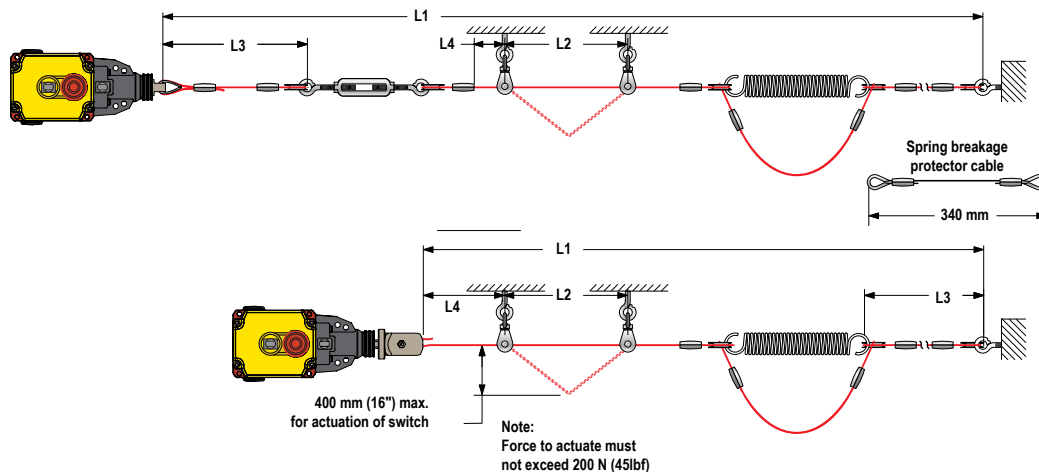

Switch Model	Max. Total Length L1	Max. Distance Between Pulleys L2	Max. Distance to Spring/Turnbuckle L3 ¹	Min. Distance Fitting to Pulley L4 ²
75 m	75 m (245 ft)	3-5 m (10-15 ft)	150 mm (6 in)	150 mm (6 in)
38 m	37.5 m (123 ft)			

All hardware is supplied by the user. See [Dimensions](#) on page 7 for switch mounting hole mounting pattern and size.

Installing Models RP-RM83F-..75 and RP-LS42F-xxLF (with Integral Turnbuckle)

These models have their own integral turnbuckle and clamp to tension the rope and to hold it in place. This innovative design provides for quick and easy rope fixing and tensioning. These models require no external turnbuckle or any additional clamp at the switch end of the rope.

To install the rope at the switch end:

1. Strip away several inches of the cable covering.
2. Loosen the set screw on the switch fitting using a 4 mm hex wrench.
3. Insert the cable into the center hole, and pull the cut end out from the side hole.
4. When the tension is correct, tighten the set screw to hold the rope firmly in place.

Figure 5. Tightening the rope into the internal turnbuckle (models RP-RM83F-..LT and -..LTE)



Tensioning the Rope

After the rope span components are installed, apply tension to the rope until the arrows in the tensioning indicator are centered on the line in the tension indicator window. This indicates sufficient rope tension. (Contacts 11/12 will close.)

1. For models RP-RM83F-..LT and RP-RM83F-..LTE: Turn the external turnbuckle until the arrows are centered. For models RP-RM83F-..LR and RP-RM83F-..LRE: Turn the shaft of the switch using a 17 mm wrench as shown, until the arrows are centered.
2. Pull hard on the rope and reset the latch several times. If the arrows in the tensioning indicator window do not return to the correct position (centered on the line in the window), further tighten or loosen the rope tension as needed, then reset, until proper tension is shown.
3. Check the tension adjustment periodically to ensure proper operation.

Figure 6. Tension Indicator Window: too little tension shown

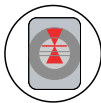

Figure 7. Tension Indicator Window: proper tension shown

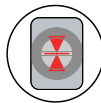

Figure 8. Adjusting rope tension (models RP-RM83F-..LT and -..LTE)



Electrical Installation

Accessing the Wiring Chamber

Access the wiring chamber by loosening the four corner screws to remove the front cover. Select the best wiring entrance and thread in the 1/2" x 14 NPSM conduit adapter (supplied), or the optional M20 x 1.5 cable gland (see Accessories). Wire the two switch contacts in series or independently.

¹ Closer, if possible

² Distance must allow necessary clearance to all mounting hardware.

Figure 9. Single-Channel Connection

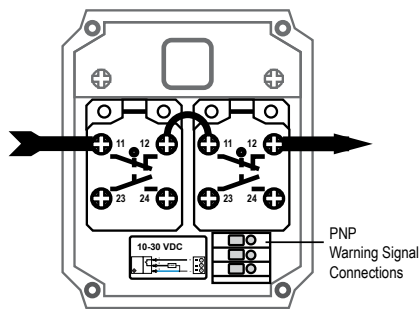
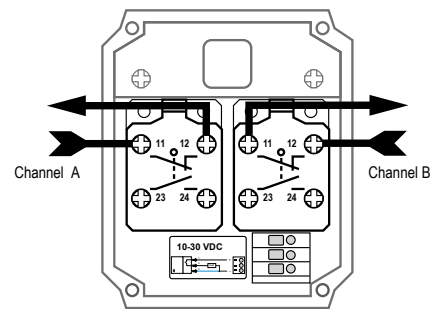

Figure 10. Dual-Channel Connection



WARNING:

- **Risk of electric shock**
- Use extreme caution to avoid electrical shock. Serious injury or death could result.
- Always disconnect power from the safety system (for example, device, module, interfacing, etc.), guarded machine, and/or the machine being controlled before making any connections or replacing any component. Lockout/tagout procedures might be required. Refer to OSHA 29CFR1910.147, ANSI Z244-1, or the applicable standard for controlling hazardous energy.
- Make no more connections to the device or system than are described in this manual. Electrical installation and wiring must be made by a Qualified Person³ and must comply with the applicable electrical standards and wiring codes, such as the NEC (National Electrical Code), NFPA 79, or IEC 60204-1, and all applicable local standards and codes.

Wiring

These switch models have redundant pairs of safety contacts, so they may be wired for either single-channel or dual-channel output to a safety module or E-stop circuit. Monitor contacts may be wired as desired to an external alarm device.



Note:

- **Proper Wiring**
- Do not operate the rope pull without properly closing the cover.
- The maximum tightening torque of the contact screws is 0.8 N·m; do not over-tighten. Before closing the front cover, verify that no wires are trapped.

Single-Channel Output: Wire contacts 11/12 together in series to the input of a safety module or E-stop circuit.

Dual-Channel Output: Wire contacts 11/12 independently to the two safety module inputs.

Warning Signal. Switch models RP-RM83F-...E provide a 24 V dc solid-state “warning signal” output, which signals when the rope tension is either too high or too low, before the safety contacts open and the switch latches OFF. This solid-state switch is located inside the wiring chamber next to the safety output contacts.

Figure 11. Warning Signal Electrical Connections

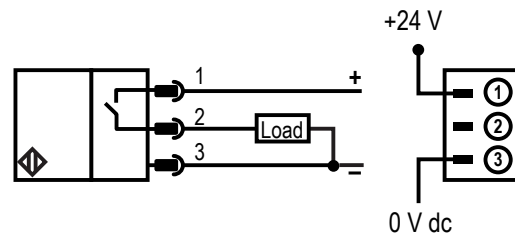

³ A person who, by possession of a recognized degree or certificate of professional training, or who, by extensive knowledge, training and experience, has successfully demonstrated the ability to solve problems relating to the subject matter and work.

Manual/Latch Reset

E-Stop and Latch Reset. Following the rope pulling/breaking or the E-stop button being pressed, the latch must be manually reset. The E-stop can be reset only when proper tension is indicated. Pull the red E-stop button until the switch Status indicator changes from Yellow to Green and the latch makes an audible “click,” indicating that the latch has been reset.



Note: Proper rope tension must be displayed before the latch can be reset.

Figure 12. Resetting the Latch

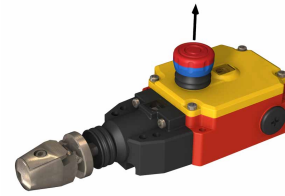

Maintenance/Checkout

At switch installation or replacement and at machine set up, a Designated Person ⁴ must test each switch for proper machine shutdown response and check the switch(es) and installation for proper operation, physical damage, mounting (looseness), and excessive environmental contamination. This must also take place on a periodic schedule determined by the user, based on the severity of the operating environment and the frequency of switch actuations. This is generally determined by a risk assessment, such as the one contained in ANSI B11.0. Adjust, repair, or replace components as needed. If inspection reveals contamination on the switch, thoroughly clean the switch and eliminate the cause of the contamination. Replace the switch and/or appropriate components when any parts or assemblies are damaged, broken, deformed, or badly worn; or if the electrical/mechanical specifications (for the environment and operating conditions) have been exceeded. Always test the control system for proper functioning under machine control conditions after performing maintenance, replacing the switch, or replacing any component of the switch.

Additional items that should be included in the checkout and/or regularly scheduled maintenance of a rope pull system:

- Check for proper rope tension and adjust as needed
- Verify free operation (no binding) of the rope and proper tripping when the rope is pulled
- Periodically lubricate the pulleys and other moving parts associated with the rope
- Repair any loose or damaged hardware, worn/frayed rope (cable), missing red rope sheathing or flags/markers (if used)
- Remove or clean off any contamination and eliminate its cause

Specifications

Contact Rating

10 A at 24 V AC
 10 A at 110 V AC
 6 A at 230 V AC
 6 A at 24 V DC
 2.5 kV maximum transient tolerance
 NEMA A300 (same polarity)

Monitoring Solid-State Output Rating

Rated operational voltage: $U_0 = 10$ to 30 V DC
 Rated operational current: = 50 mA
 Utilization category: DC13
 Protected against reverse polarity and short circuit

Wire Connections

Screw terminals with pressure plates accept the following wire sizes:
 Stranded and solid: 20 AWG (0.5 mm²) to 16 AWG (1.5 mm²) for one wire

Mechanical Life

100,000 operations per IEC 60947-5-5

Cable Entry

M20 × 1.5 threaded entrance. Adapter supplied to convert M20 × 1.5 to ½"-14 NPT threaded entrance

⁴ A Designated Person is identified in writing by the employer as being appropriately trained to perform a specified checkout procedure.

European Rating

Rated Isolation Voltage (Ui): 250 V
 Rated Impulse Without Voltage (Uimp): 2.5 kV
 Conventional Thermal Current (Ithe): 10 A
 Utilization Category
 Protection Class I

AC-15, U_e/I_e 240 V/3 A; 120 V/6 A
 DC-13, U_e/I_e 250 V/0.27 A; 125 V/0.55 A

Protection Class III

AC-15, U_e/I_e 50 V/6 A
 DC-13, U_e/I_e 120 V/0.55 A

Contact Material

Silver-nickel alloy

Maximum Switching Speed

20 operations per minute

Recommended Rope Size

Accommodates rope sizes 2 to 5 mm diameter steel rope (see Accessories);
 select rope diameter based on switch model and rope length
 75 m models: recommended 2 to 5 mm diameters
 38 m models: recommended 2 to 5 mm diameters

Short Circuit Protection

6 A DII gG Fuse
 Recommended external fusing or overload protection.

B10d

2×10^5 cycles at DC-13; 24 V; $I_{e2} = 0.1$ A

Construction

Die-cast aluminum housing; zinc die-cast actuator

Maximum Rope Pull Length

75 m (245 ft) or 37.5 m (123 ft), depending on model

Environmental Rating

NEMA 4, IEC IP67, per IEC/EN 60529

Operating Conditions

-30 °C to +80 °C (-22 °F to +176 °F)

Weight

RP-RM83F-..LT and -..LTE: 1Kg (2.1 lbs.)
 RP-RM83F-..LR and -..LRE: 0.77 Kg (1.6 lbs.)

Product Performance Standards

DIN EN 60947-1, DIN EN 60947-5-1, DIN EN 60947-5-5, IEC 60947-1, IEC 60947-5-1, IEC 60947-5-5, ISO 13850

Certifications



Banner Engineering Europe
 Park Lane, Culliganlaan 2F
 bus 3, 1831 Diegem,
 BELGIUM

Turck Banner LTD Blenheim
 House, Blenheim Court,
 Wickford, Essex SS11 8YT,
 Great Britain

Dimensions

Figure 13. RP-RM83F-..LR..

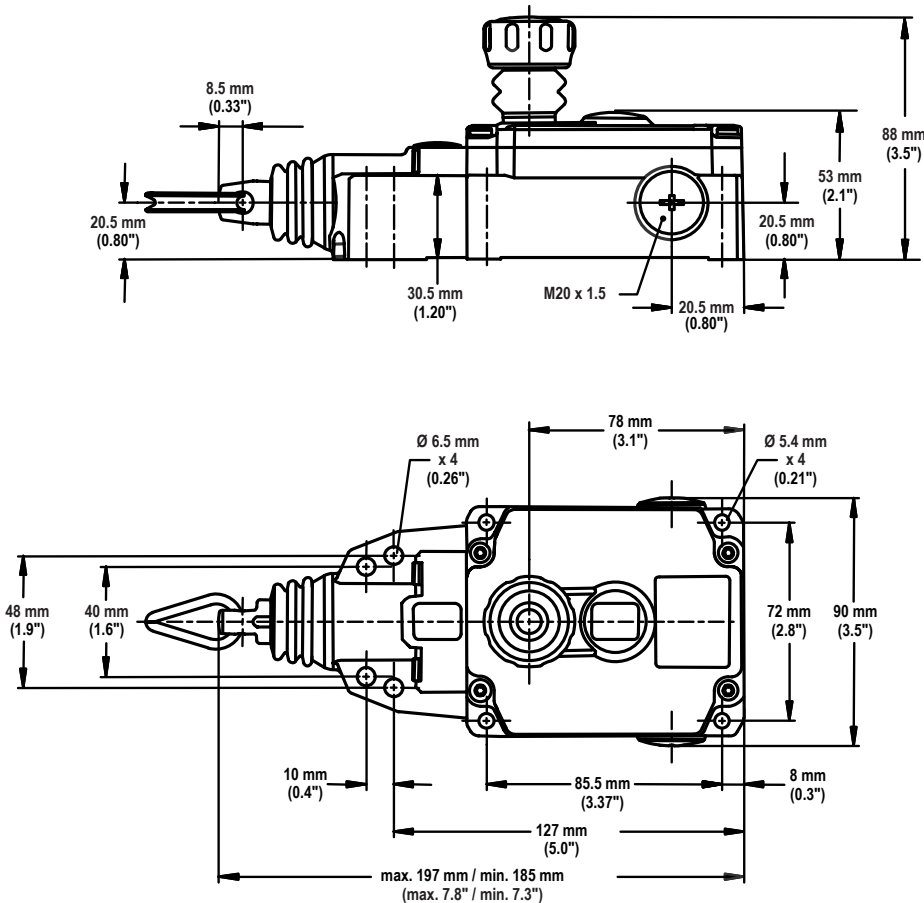
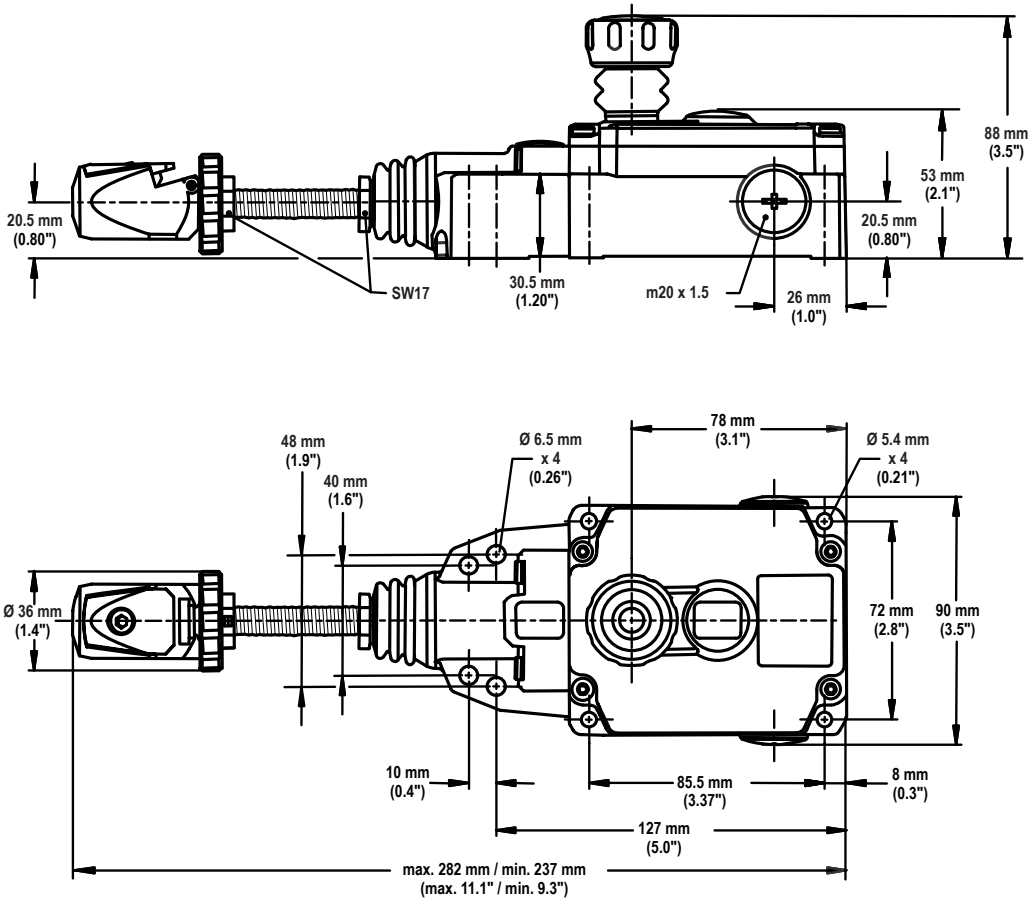
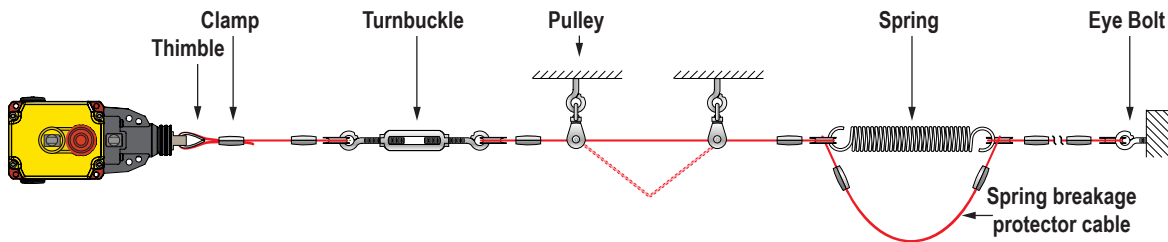



Figure 14. RP-RM83F-..LT..





Accessories

Figure 15. Wire Rope Assembly Components





Model	Length	Description	Wire Rope
RPA-C1-10	10 m (32.8 ft)	2 mm steel wire rope with 0.5 mm red PVC jacket (unterminated)	
RPA-C1-20	20 m (65.6 ft)		
RPA-C1-100	100 m (328.1 ft)		

Model	Length	Description	Wire Rope
RPA-C2-10	10 m (32.8 ft)	3 mm steel wire rope with 0.5 mm red PVC jacket (unterminated)	
RPA-C2-20	20 m (65.6 ft)		
RPA-C2-40	40 m (131.2 ft)		
RPA-C2-50	50 m (164.0 ft)		
RPA-C2-80	80 m (262.4 ft)		

Model	Length	Description	Wire Rope
RPA-C3-20	20 m (65.6 ft)	4 mm steel wire rope with 0.5 mm red PVC jacket (unterminated)	
RPA-C3-100	100 m (328.1 ft)		



Model	Quantity	Description	Thimble
RPA-T1-4	4	Thimble for 2 mm wire rope	
RPA-T2-4	4	Thimble for 3 mm wire rope	
RPA-T3-4	4	Thimble for 4 mm wire rope	

Model	Quantity	Description	Clamp
RPA-CC1-4	4	Clamp for 2 mm wire rope	
RPA-CC2-4	4	Clamp for 3 mm wire rope	
RPA-CC3-4	4	Clamp for 4 mm wire rope	

Model	Quantity	Description	Turnbuckle
RPA-TA1-1	1	#4 Turnbuckle	

Model	Quantity	Description	Eye Bolt
RPA-EB1-1	1	¼ in -20 Eye bolt (3 in bolt shaft)	

Model	Quantity	Description	Eye Bolt
RPA-EB2-1	1	5/16 in-18 Eye bolt (3 in bolt shaft)	

Model	Quantity	Description	Pulley
RPA-P1-1	1	Hanging pulley for in-line use	
RPA-DP1-1	1	Right-angle mount deflection pulley for corner turns (90° to 180°)	

Model	Quantity	Description	Tensioning Spring	Used With
RPA-S3-1	1	Tensioning spring #3		RP-LM40D-6 RP-LM40D-6L RP-RM83F-..75..
RPA-S5-1	1	Tensioning spring #5		RP-RM83 models (38 m) RP-LS42 models (25 & 38 m)

Model	Quantity	Description	Tensioning Spring	Used With
RPA-S4-1	1	Tensioning spring #4 with built-in eye bolt (used with customer-supplied M12 × 1.75 pitch nut), cable thimble, clamping, tensioning, and overload protection.		RP-LM40D-6 RP-LM40D-6L RP-RM83F-..75..
RPA-S6-1	1	Tensioning spring #6 with built-in eye bolt (used with customer-supplied M12 × 1.75 pitch nut), cable thimble, clamping, tensioning, and overload protection.		RP-RM83F-..38..

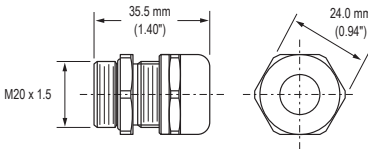
Model	Size	For Cable Diameter	Dimensions	Used With
SI-QM-CGM20	M20 × 1.5 Metal	5.0 to 12.0 mm (0.20 to 0.47 inches)		RP-RM83 Rope Pull Switch RP-LM40 Rope Pull Switch RP-QM72/QMT72 Rope Pull Switch RP-QM90 Rope Pull Switch SI-LM40 Safety Interlock Switch

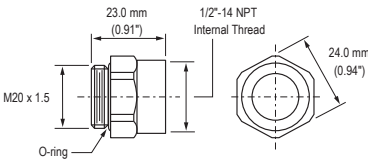
Model	Size	Thread Conversion	Dimensions	Used With
SI-QM-M20	½ in-14 NPT Metal	M20 × 1.5 to ½ in-14 NPT		SI-LM40 Safety Interlock Switches RP-LM40 Rope Pull Switches RP-QM72/QMT72 Rope Pull Switches RP-QM90 Rope Pull Switches RP-RM83 Rope Pull Switches

Product Support and Maintenance

Repairs

Contact Banner Engineering for troubleshooting of this device. **Do not attempt any repairs to this Banner device; it contains no field-replaceable parts or components.** If the device, device part, or device component is determined to be defective by a Banner Applications Engineer, they will advise you of Banner's RMA (Return Merchandise Authorization) procedure.



Important: If instructed to return the device, pack it with care. Damage that occurs in return shipping is not covered by warranty.

EU/UK Declaration of Conformity (DoC)

Banner Engineering Corp. herewith declares that these products are in conformity with the provisions of the listed directives, regulations, and all essential health and safety requirements have been met. For the complete DoC, please go to www.bannerengineering.com.

Product	Directive
RP-RM83F Heavy-Duty Rope Pull Emergency Stop Switch	EU: Machinery Directive 2006/42/EC UK: Machinery (Safety) Regulations 2008

Representative in EU: Spiridon Lachanidis, Managing Director, **Banner Engineering Europe** Park Lane, Culliganlaan 2F bus 3, 1831 Diegem, BELGIUM

Representative in UK: Tony Coghlan, Managing Director, **Turck Banner LTD** Blenheim House, Blenheim Court, Wickford, Essex SS11 8YT, Great Britain