

# Features

# Evaluation Module

- Evaluation platform for RPMB-2.0 Power Modules
- Thermal design considerations included
- EMI Class B filter
- Easy evaluation of control, power good and sensing functions

**RECOM**  
Evaluation Module

## RPMB-2.0-EVM-1

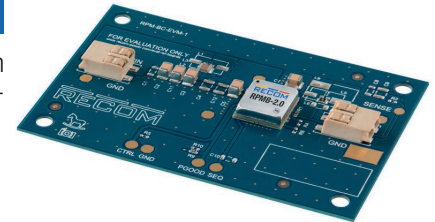

## Description

The RPMB-2.0-EVM-1 generates a constant output voltage with an output current up to 2.0A from an external DC source. Functions of the RPMB-2.0 such as trimming, control, and sensing can be evaluated. Also the behavior in overload or over temperature can be evaluated easily before design-in.

## Selection Guide

Part Number	Input Voltage Range [VDC]	nom. Output Voltage [VDC]	Vout Adjust Range [VDC]	Output Current max. [A]
RPMB3.3-2.0-EVM-1	4-36	3.3	1-9	2.0
RPMB5.0-2.0-EVM-1	5.5-36	5	1-9	2.0
RPMB12-2.0-EVM-1	12.8-36	12	9-24	2.0
RPMB15-2.0-EVM-1	16-36	15	9-24	2.0

## Quick Start Guide

- 1) Connect P1 to power supply (observe correct polarity!)
- 2) Connect P2 to a Load
- 3) Connect sense to the required potential  
The sense preset is via R1 directly at the power module, so the preset voltage is very accurate at the output of the RPMB-2.0. To equalize ohmic losses of the output filter, remove the resistor at R1, and solder a 0 $\Omega$  resistor at R2.
- 4) Disable the device via R5  
The device is preset as normally on. It can be disabled by pulling the CTRL pad to GND. Short R5 to disable the device.

Specifications (measured @ Ta= 25°C, full load after warm up unless otherwise stated)

### Component Placement

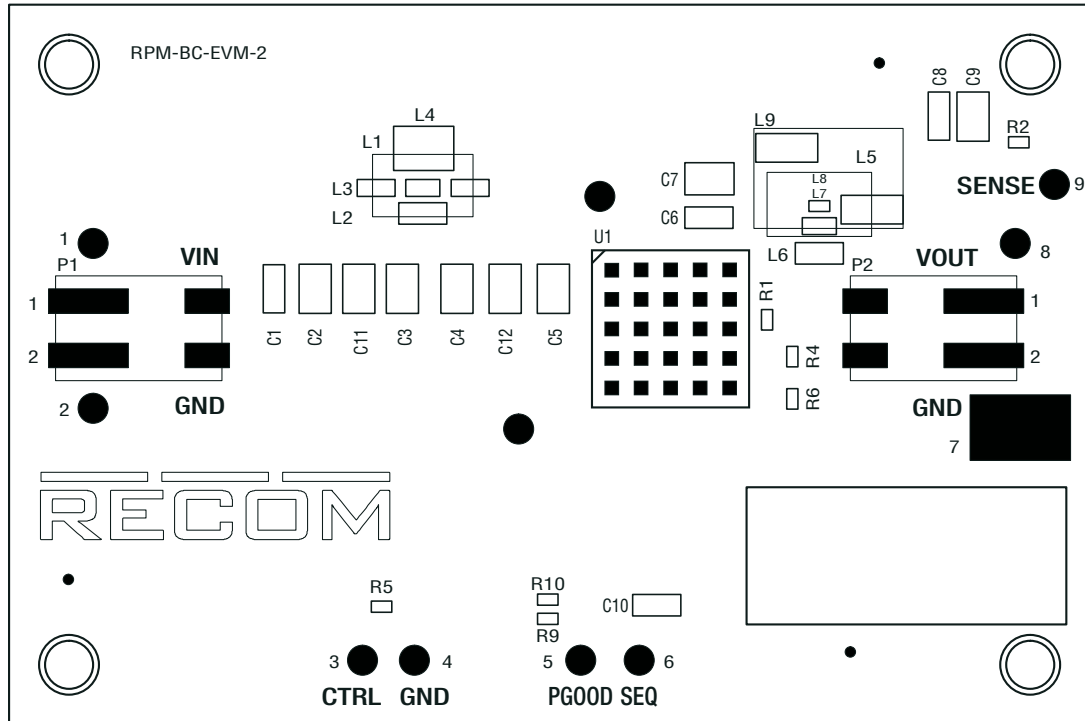

### Connector Description

#### P1

Pin	Name	Description
1	$V_{in}$	Positive Input Voltage (observe correct polarity!)
2	GND	Common GND

#### P2

Pin	Name	Description
1	$V_{out}$	Positive Output Voltage
2	GND	Common GND

#### PADS direct connection

Pin	Name	Description
1	$V_{in}$	Positive Input Voltage
2	GND	Common GND
3	CTRL	CTRL Pin (leave open if not used)
4	GND	Common GND
5	PGOOD	Power good signal
6	SEQ	Sequencing and soft start (not applicable for RPMB-2.0-EVM-1)
7	GND	Common GND, can connect oscilloscope GND for measurement
8	$V_{out}$	Positive Output Voltage
9	SENSE	Output Voltage Sense Pin (leave open if not used)

Specifications (measured @ Ta= 25°C, full load after warm up unless otherwise stated)

## Schematic

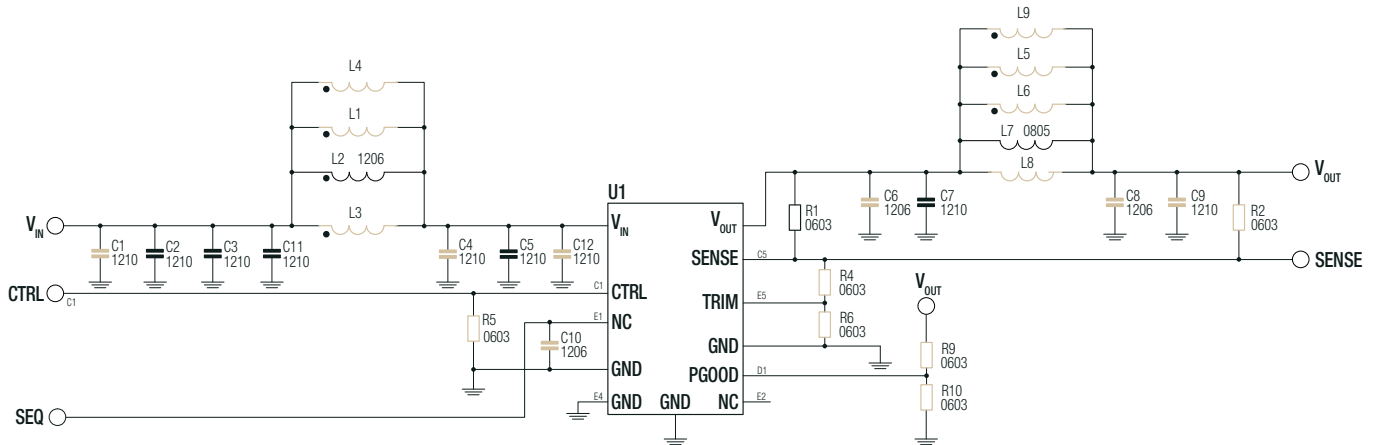

### Notes:

Note1: Grey colored components are not mounted

## Description

U1: RPMB-2.0 power module.

C1, C2, C3, C11, L1, L2, L3, L4, C4, C5, C12: allow placement of various sized components to test input filter design. The populated filter is designed to meet EN55032 class B ew

C6, C7, L5, L6, L7, L8, L9, C8, C9: allow placement of various sized components to test output filter design. The populated filter is designed to meet EN55032 class B

R5: connect 0Ω resistor to disable the module. This resistor is not populated.

C10: not applicable for RPMB-2.0-EVM-1

R9 and R10: leave open (RPMB-2.0 has PGOOD internally pulled up to 5V)

R1: populated 0Ω resistor for direct output voltage measurement. If sense is desired at a different location, for example after the filter or directly at the load, remove R1, and connect sense to the new measurement point.

R2: sense point for output voltage after the filter. To set sense point here, remove R1 and solder a 0Ω resistor at R2.

R4 and R6: trim the output voltage. Refer to **"OUTPUT VOLTAGE TRIMMING"**

### Specifications (measured @ Ta= 25°C, full load after warm up unless otherwise stated)

#### OUTPUT VOLTAGE TRIMMING

The RPMB-series offers the feature of trimming the output voltage by using external trim resistors. The values for trim resistors shown in trim tables below are according to standard E96 values; therefore, the specified voltage may slightly vary. Refer to **"Selection Guide"** for applicable Vout range.

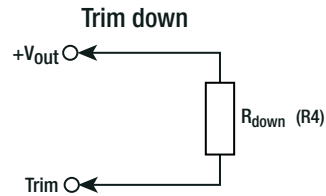
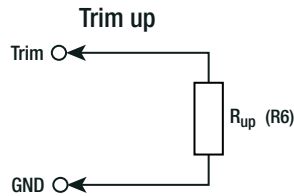

#### Calculation:

$V_{out_{nom}}$  = nominal output voltage [VDC]  
 $V_{out_{set}}$  = trimmed output voltage [VDC]  
 $R_{up}$  (R6) = trim up resistor [kΩ]  
 $R_{down}$  (R4) = trim down resistor [kΩ]  
 $R_{Hi}, R_{Lo}$  = internal resistors [kΩ]

Vout <sub>nom</sub>	R <sub>Hi</sub>	R <sub>Lo</sub>
3.3VDC	100kΩ	43.2kΩ
5VDC	100kΩ	24.9kΩ
12VDC	100kΩ	9.09kΩ
15VDC	90.9kΩ	6.49kΩ

$$R_{up} = \frac{R_{Lo} \times (V_{out_{set}} - 1) - R_{Hi} \times (R_{Lo} + 1)}{R_{Hi} - R_{Lo} \times (V_{out_{set}} - 1)}$$

$$R_{down} = \frac{R_{Lo} \times (V_{out_{set}} - 1) \times (R_{Hi} + 1) - R_{Hi}}{R_{Hi} - R_{Lo} \times (V_{out_{set}} - 1)}$$

#### Practical Example RPMB5.0-2.0, trim up

Vout<sub>set</sub> = 5.5VDC

$$R_{up} = \frac{24.9 \times (5.5 - 1) - 100 \times (24.9 + 1)}{100 - 24.9 \times (5.5 - 1)}$$

R<sub>up</sub> according to E96 ≈ **205kΩ**

#### Practical Example RPMB3.3-2.0, trim down

Vout<sub>set</sub> = 1.2VDC

$$R_{down} = \frac{43.2 \times (1.2 - 1) \times (100 + 1) - 100}{100 - 43.2 \times (1.2 - 1)}$$

R<sub>down</sub> according to E96 ≈ **8k45Ω**

#### RPMB3.3-2.0

##### Trim up

Vout <sub>set</sub> =	5	[VDC]
R <sub>up</sub> (E96) ≈	57k6	[Ω]

##### Trim down

Vout <sub>set</sub> =	2.5	1.8	1.5	1.1	[VDC]
R <sub>down</sub> (E96) ≈	182k	52k3	26k7	3k48	[Ω]

#### RPMB12-2.0

##### Trim up

Vout <sub>set</sub> =	15	24	[VDC]
R <sub>up</sub> (E96) ≈	32k4	7k32	[Ω]

##### Trim down

Vout <sub>set</sub> =	10	9	[VDC]
R <sub>down</sub> (E96) ≈	453k	267k	[Ω]

#### RPMB5.0-2.0

##### Trim up

Vout <sub>set</sub> =	5.5	9	[VDC]
R <sub>up</sub> (E96) ≈	205k	23k7	[Ω]

##### Trim down

Vout <sub>set</sub> =	3.3	2.5	[VDC]
R <sub>down</sub> (E96) ≈	133k	59k	[Ω]

#### RPMB15-2.0

##### Trim up

Vout <sub>set</sub> =	20	24	[VDC]
R <sub>up</sub> (E96) ≈	16k9	9k09	[Ω]

##### Trim down

Vout <sub>set</sub> =	12	9.99	[VDC]
R <sub>down</sub> (E96) ≈	332k	162k	[Ω]

**Specifications** (measured @ Ta= 25°C, full load after warm up unless otherwise stated)

**DIMENSION AND PHYSICAL CHARACTERISTICS**

Parameter	Type	Value
Dimension (LxWxH)		85.0 x 55.0 x 5.9mm
Weight		20g

**Layout**

Top Layer

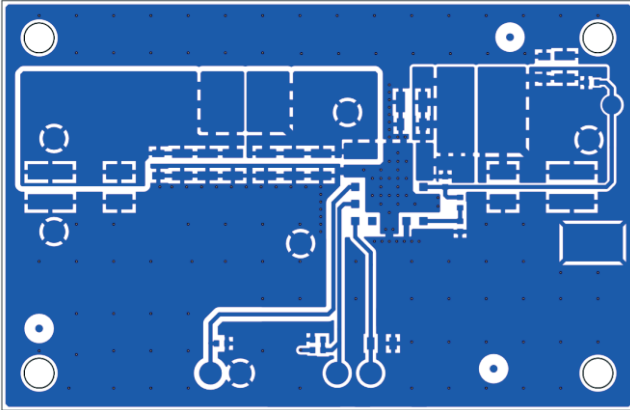

Layer 2 (Signal)

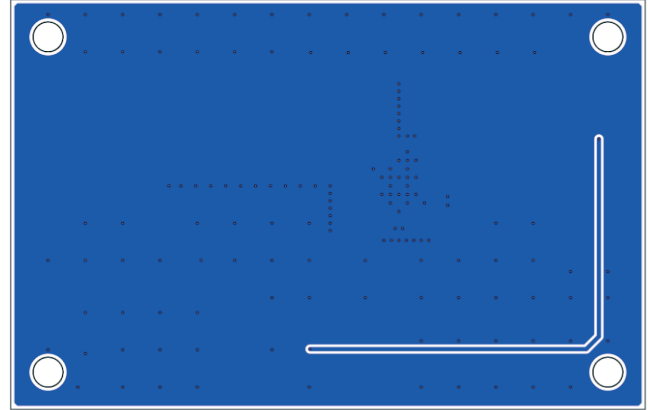

Layer 3 (GND)

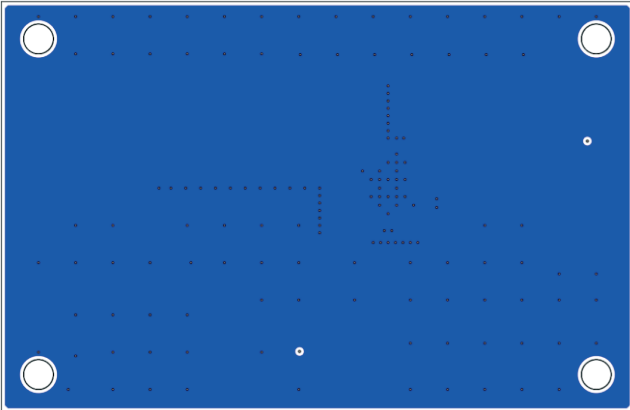

Bottom (GND)

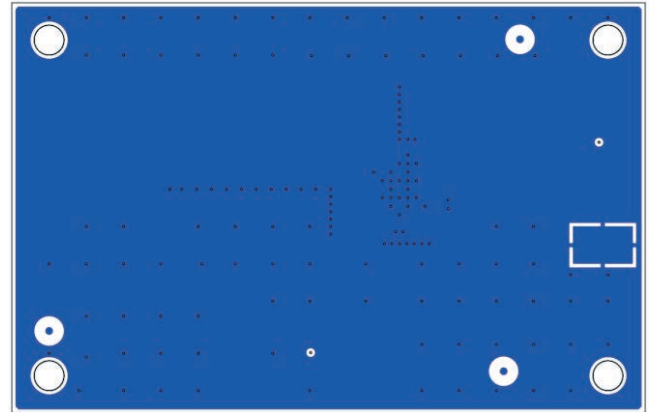

**Notes:**

Note2: Visit [www.recom-power.com/eval-ref-boards](http://www.recom-power.com/eval-ref-boards) to download the Gerber files

**Specifications** (measured @ Ta= 25°C, full load after warm up unless otherwise stated)

**BOM**

**RPMB-2.0-EVM-1 (all versions)**

Component	Description	Manufacturer Part Number	Manufacturer	Remarks
C1	1206			Not Mounted
C2	10µF 50V X7R 1210	12105C106KAT2A	AVX	
C3	10µF 50V X7R 1210	12105C106KAT2A	AVX	
C4	1210			Not Mounted
C5	10µF 50V X7R 1210	12105C106KAT2A	AVX	
C6	1206			Not Mounted
C7	10µF 50V X7R 1210	12105C106KAT2A	AVX	
C8	1206			Not Mounted
C9	1210			Not Mounted
C10	1206			Not Mounted
C11	10µF 50V X7R 1210	12105C106KAT2A	AVX	
C12	1210			Not Mounted
L1	8.8mm x 4.75mm			Not Mounted
L2	2.2uH 1206	DFE252012F-2R2M=P2	Murata	
L3	0805			Not Mounted
L4	4.5mm x 3.2mm			Not Mounted
L5	8.8mm x 4.75mm			Not Mounted
L6	1206			Not Mounted
L7	0 OHM JUMPER 0805 0W125	CRCW08050000Z0ECC	VISHAY	Use 0R 0805
L8	0603			Not Mounted
L9	11.68mm x 7.2mm			Not Mounted
P1	CONNECTOR	695402400222	WURTH	
P2	CONNECTOR	695402400222	WURTH	
R1	0 OHM JUMPER 0603 0W1	CRCW06030000Z0EAC	VISHAY	
R2	0 OHM JUMPER 0603 0W1	CRCW06030000Z0EAC	VISHAY	Not Mounted
R4	0603			Not Mounted
R5	0603			Not Mounted
R6	0603			Not Mounted
R9	0603			Not Mounted
R10	0603			Not Mounted
U1	RPMB3.3-2.0 MODULES RPMB5.0-2.0 MODULES RPMB12-2.0 MODULES RPMB15-2.0 MODULES	RPMB3.3-2.0 RPMB5.0-2.0 RPMB12-2.0 RPMB15-2.0	RECOM	3.3Vout version 5.0Vout version 12Vout version 15Vout version