

Features

Evaluation Module

- Evaluation platform for RPMH-0.5 Power Modules
- Thermal design considerations included
- EMI Class B filter
- Easy evaluation of control, power good and sensing functions

RECOM
Evaluation Module

RPMH-0.5-EVM-1

Description

The RPMH-0.5-EVM-1 generates a constant output voltage with an output current up to 0.5A from an external DC source. All the functions of the RPMH-0.5 such as trimming, sequencing, control, and sensing can be evaluated. Also the behavior in overload or over temperature can be evaluated easily before design-in.

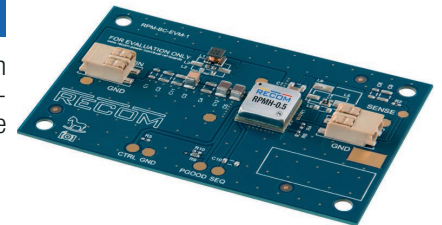

Selection Guide

| Part Number | Input Voltage Range [VDC] | Output Voltage nom. [VDC] | Vout Adjust Range [VDC] | Output Current max. [A] |
|-------------------|---------------------------|---------------------------|-------------------------|-------------------------|
| RPMH3.3-0.5-EVM-1 | 4.3-65 | 3.3 | 2.64-3.63 | 0.5 |
| RPMH5.0-0.5-EVM-1 | 6-65 | 5 | 4-5.5 | 0.5 |
| RPMH12-0.5-EVM-1 | 13.5-65 | 12 | 7.2-13.2 | 0.5 |
| RPMH15-0.5-EVM-1 | 16.5-65 | 15 | 9-16.5 | 0.5 |
| RPMH24-0.5-EVM-1 | 25.5-65 | 24 | 15-28 | 0.5 |

Quick Start Guide

- 1) Connect P1 to power supply (observe correct polarity!)
- 2) Connect P2 to a Load
- 3) Connect sense to the required potential
The sense preset is via R1 directly at the power module, so the preset voltage is very accurate at the output of the RPMH-0.5. To equalize ohmic losses of the output filter, remove the resistor at R1, and solder a 0 Ω resistor at R2.
- 4) Disable the device via R5
The device is preset as normally on. It can be disabled by pulling the CTRL pad to GND. Short R5 to disable the device.

Specifications (measured @ Ta= 25°C, full load after warm up unless otherwise stated)

Component Placement

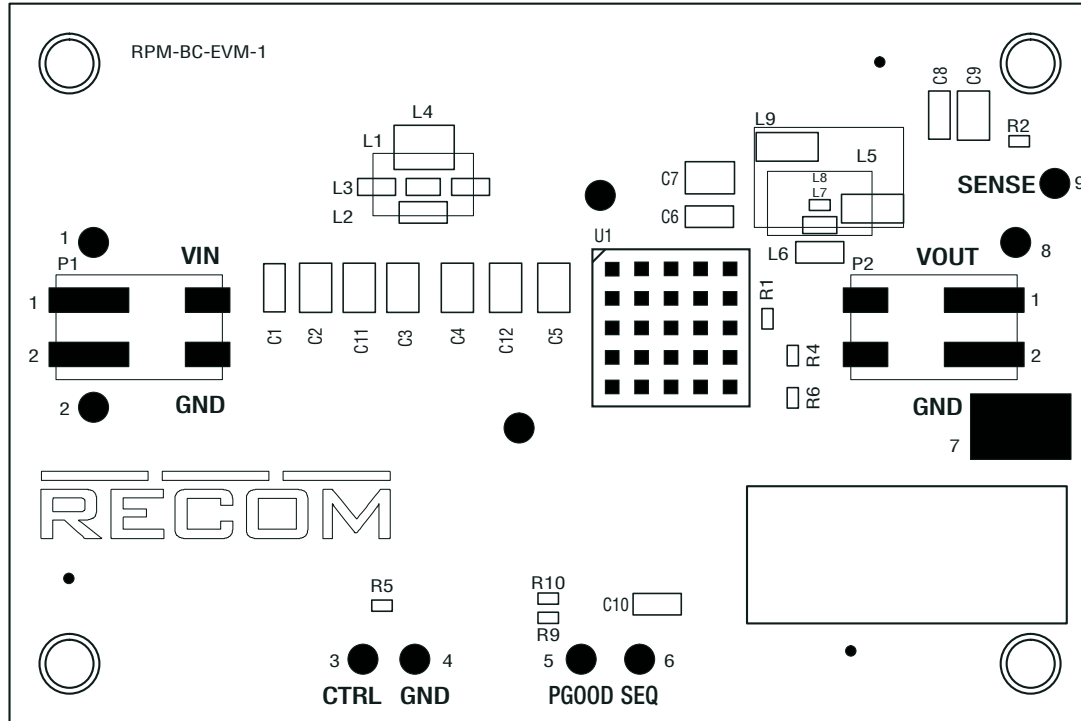

Connector Description

P1

| Pin | Name | Description |
|-----|----------|--|
| 1 | V_{in} | Positive Input Voltage (observe correct polarity!) |
| 2 | GND | Common GND |

P2

| Pin | Name | Description |
|-----|-----------|-------------------------|
| 1 | V_{out} | Positive Output Voltage |
| 2 | GND | Common GND |

PADS direct connection

| Pin | Name | Description |
|-----|-----------|--|
| 1 | V_{in} | Connect to V_{in} |
| 2 | GND | Common GND |
| 3 | CTRL | CTRL Pin (leave open if not used) |
| 4 | GND | Common GND |
| 5 | PGOOD | Power good signal |
| 6 | SEQ | Sequencing and soft start |
| 7 | GND | Common GND, can connect oscilloscope GND for measurement |
| 8 | V_{out} | Positive Output Voltage |
| 9 | SENSE | Output Voltage Sense Pin (leave open if not used) |

Specifications (measured @ Ta= 25°C, full load after warm up unless otherwise stated)

Schematic

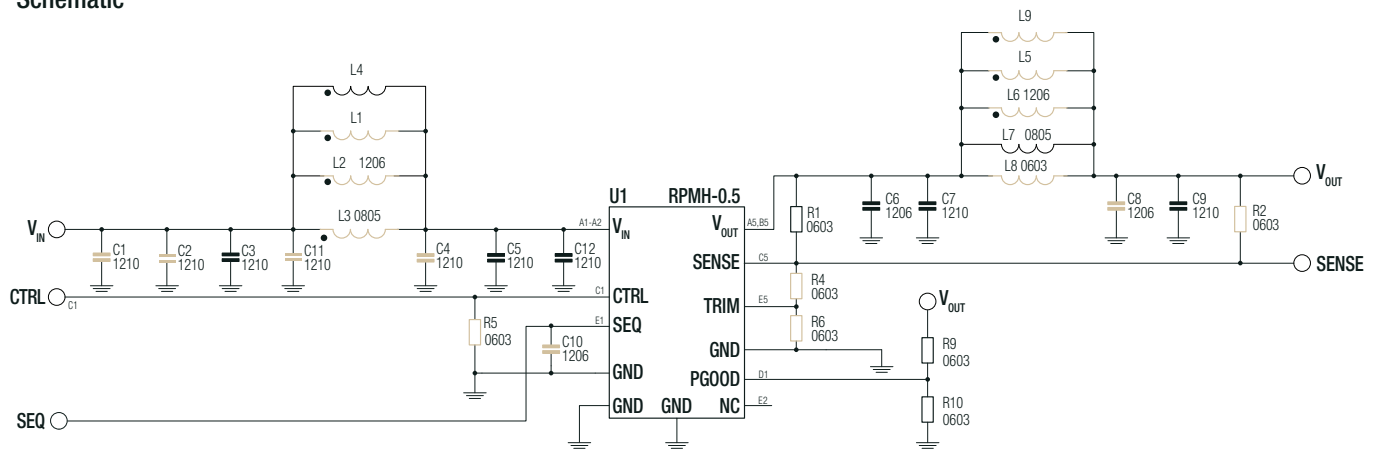

Notes:

Note1: Grey colored components are not mounted

Description

U1: RPMH-0.5 power module.

C1,C2,C3,C11,L1,L2,L3,L4,C4,C5,C12: allow placement of various sized components to test input filter design. The populated filter is designed to meet EN55032 class B

C6,C7,L5,L6,L7, L8, L9,C8,C9: allow placement of various sized components to test output filter design. The populated filter is designed to meet EN55032 class B

R5: connect 0Ω resistor to disable the module. This resistor is not populated.

C10: sets soft-start time. Refer to RPMH-0.5 datasheet for more information.

R9: populated 100kΩ resistor which is pulled up to VOUT. This is for output power good signal.

R10: this resistor is only populated for RPMH12-0.5-EVM-1, RPMH15-0.5-EVM-1, and RPMH24-0.5-EVM-1. This limits the voltage of PGOOD signal to half the output voltage. Refer to RPMH-0.5 datasheet for more information.

R1: populated 0Ω resistor for direct output voltage measurement. If sense is desired at a different location, for example after the filter or directly at the load), desolder R1, and connect sense to the new measurement point.

R2: sense point for output voltage after the filter. To set sense point here, remove R1 and solder a 0Ω resistor at R2.

R4 and R6: trim the output voltage. Refer to „**OUTPUT VOLTAGE TRIMMING**“

OUTPUT VOLTAGE TRIMMING

The RPMH-series offers the feature of trimming the output voltage over a range between -20% to +10% for lower output voltages and from -40% to +10% for higher output voltages. This can be done by using external trim resistors. The values for the trim resistors in trim tables are according to standard E96 values; therefore, the specified voltage may slightly vary.

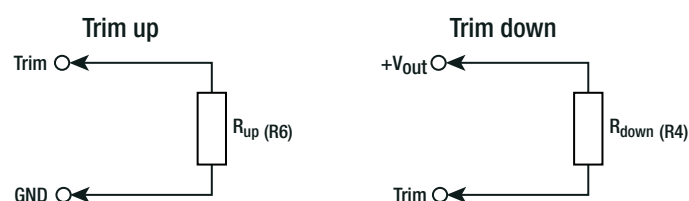

continued on next page

Specifications (measured @ Ta= 25°C, full load after warm up unless otherwise stated)

Calculation:

- V_{out_nom} = nominal output voltage [VDC]
- V_{out_set} = trimmed output voltage [VDC]
- V_{ref} = reference voltage [VDC]
- R_{up} = trim up resistor [kΩ]
- R_{down} = trim down resistor [kΩ]
- R_{Hi}, R_{Lo} = internal resistors [kΩ]

| V_{out_nom} | R_{Hi} | R_{Lo} | V_{ref} |
|----------------|----------|----------|-----------|
| 3.3VDC | 205kΩ | 169kΩ | 1.223k |
| 5VDC | 374kΩ | 309kΩ | |
| 12VDC | 1.22MΩ | 1MΩ | |
| 15VDC | 1.22MΩ | 1MΩ | |
| 24VDC | 1.22MΩ | 1MΩ | |

$$R_{up} = \left[\frac{R_{Hi}}{V_{out_set} - V_{nom}} \right] - 1k$$

$$R_{down} = \left[\frac{(V_{out_set} - V_{ref}) \times R_{Lo}}{V_{out_nom} - V_{set}} \right]$$

Practical Example RPMH3.3-0.5, trim up

$V_{out_set} = 3.63VDC$

$$R_{up} = \left[\frac{205k}{3.63 - 3.3} \right] - 1k = \underline{\underline{621k\Omega}}$$

R_{up} according to E96 \approx 619kΩ

Practical Example RPMH3.3-0.5, trim down

$V_{out_set} = 2.64VDC$

$$R_{down} = \left[\frac{(2.64 - 1.223) \times 169k}{3.3 - 2.64} \right] = \underline{\underline{363k\Omega}}$$

R_{down} according to E96 \approx 365kΩ

RPMH3.3-0.5

Trim up

| | | | | |
|--------------------------|------|------|-------|-------|
| $V_{out_set} =$ | 3.4V | 3.5V | 3.63V | [VDC] |
| R_{up} (E96) \approx | 2M05 | 1M02 | 619k | [Ω] |

Trim down

| | | | | | |
|----------------------------|------|----|------|-------|-------|
| $V_{out_set} =$ | 3.1V | 3V | 2.8V | 2.64V | [VDC] |
| R_{down} (E96) \approx | 1M58 | 1M | 536k | 365k | [Ω] |

RPMH5.0-0.5

Trim up

| | | | | |
|--------------------------|------|------|------|-------|
| $V_{out_set} =$ | 5.1V | 5.3V | 5.5V | [VDC] |
| R_{up} (E96) \approx | 3M74 | 1M24 | 750k | [Ω] |

Trim down

| | | | | | |
|----------------------------|------|------|------|------|-------|
| $V_{out_set} =$ | 4.7V | 4.5V | 4.3V | 4V | [VDC] |
| R_{down} (E96) \approx | 3M57 | 2M | 1M33 | 845k | [Ω] |

RPMH12-0.5

Trim up

| | | | | | | |
|--------------------------|------|------|------|-----|------|-------|
| $V_{out_set} =$ | 12.4 | 12.6 | 12.8 | 13 | 13.2 | [VDC] |
| R_{up} (E96) \approx | 3M01 | 2M | 1M5 | 1M2 | 1M | [Ω] |

Trim down

| | | | | | | | | |
|----------------------------|------|-----|------|------|------|-----|------|-------|
| $V_{out_set} =$ | 10 | 9.6 | 9 | 8.5 | 8 | 7.7 | 7.2 | [VDC] |
| R_{down} (E96) \approx | 4M32 | 3M4 | 2M61 | 2M05 | 1M69 | 1M5 | 1M24 | [Ω] |

continued on next page

Specifications (measured @ Ta= 25°C, full load after warm up unless otherwise stated)

RPMH15-0.5

Trim up

| | | | | | | | |
|-------------------------|------|------|------|------|------|------|-------|
| V _{outset} = | 15.5 | 15.7 | 15.9 | 16.1 | 16.3 | 16.5 | [VDC] |
| R _{up} (E96) ≈ | 2M4 | 1M74 | 1M33 | 1M1 | 931k | 820k | [Ω] |

Trim down

| | | | | | | | | |
|---------------------------|-----|------|-----|------|------|-----|-----|-------|
| V _{outset} = | 12 | 11.5 | 11 | 10.5 | 10 | 9.5 | 9 | [VDC] |
| R _{down} (E96) ≈ | 3M6 | 2M94 | 2M4 | 2M05 | 1M74 | 1M5 | 1M3 | [Ω] |

RPMH24-0.5

Trim up

| | | | | | | | | |
|-------------------------|------|-----|------|------|------|------|------|-------|
| V _{outset} = | 24.5 | 25 | 25.5 | 26 | 26.4 | 27 | 28 | [VDC] |
| R _{up} (E96) ≈ | 2M43 | 1M2 | 806k | 604k | 511k | 402k | 300k | [Ω] |

Trim down

| | | | | | | | | | | |
|---------------------------|------|------|-----|------|------|------|------|------|-----|-------|
| V _{outset} = | 19.5 | 19.2 | 18 | 17.5 | 17 | 16.5 | 16 | 15.5 | 15 | [VDC] |
| R _{down} (E96) ≈ | 3M9 | 3M74 | 2M8 | 2M49 | 2M26 | 2M | 1M82 | 1M69 | 1M5 | [Ω] |

DIMENSION AND PHYSICAL CHARACTERISTICS

| Parameter | Type | Value |
|-------------------|------|---------------------|
| Dimension (LxWxH) | | 85.0 x 55.0 x 5.9mm |
| Weight | | 20.5g. typ. |

Layout

Top Layer

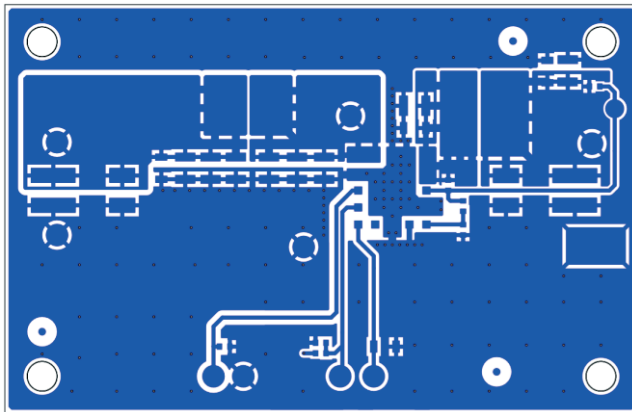

Layer 2 (GND)

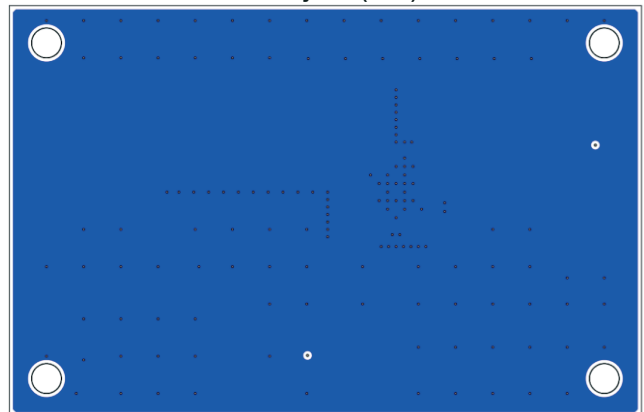

Layer 3 (Single)



Bottom (GND)

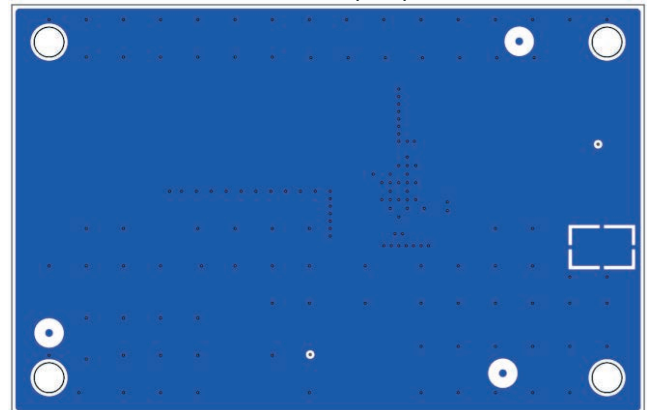

Notes:

Note2: Visit www.recom-power.com/eval-ref-boards to download the Gerber files.

Specifications (measured @ Ta= 25°C, full load after warm up unless otherwise stated)

BOM

RPMH3.3-0.5-EVM-1 or RPMH5.0-0.5-EVM-1

| Component | Description | Manufacturer Part Number | Manufacturer | Remarks |
|-----------|-----------------------------------|------------------------------|--------------|------------------------------------|
| C1 | 1206 | | | Not Mounted |
| C2 | 1210 | | | Not Mounted |
| C3 | 2.2µF 100V X7R 1210 | 12101C225KAT4A | AVX | |
| C4 | 1210 | | | Not Mounted |
| C5 | 4.7µF 100V X7R 1210 | 12101C475K4T2A | AVX | X7S as alternate |
| C6 | 22µF 10V X7R 1206 | 1206ZC226KAT2A | AVX | |
| C7 | 1210 | | | Not Mounted |
| C8 | 1206 | | | Not Mounted |
| C9 | 1210 | | | Not Mounted |
| C10 | 1206 | | | Not Mounted |
| C11 | 1210 | | | Not Mounted |
| C12 | 4.7µF 100V X7R 1210 | 12101C475K4T2A | AVX | X7S as alternate |
| L1 | 8.8mm x 4.75mm | | | Not Mounted |
| L2 | 1206 | | | Not Mounted |
| L3 | 0805 | | | Not Mounted |
| L4 | FIXED INDUCTOR 12µH 0.8A | RLS-126 | RECOM | |
| L5 | 8.8mm x 4.75mm | | | Not Mounted |
| L6 | 1206 | | | Not Mounted |
| L7 | 0 OHM JUMPER 0805 0W125 | CRCW08050000Z0ECC | VISHAY | Use 0R 0805 |
| L8 | 0603 | | | Not Mounted |
| L9 | 11.68mm x 7.2mm | | | Not Mounted |
| P1 | CONNECTOR | 695402400222 | WURTH | |
| P2 | CONNECTOR | 695402400222 | WURTH | |
| R1 | 0 OHM JUMPER 0603 0W1 | CRCW06030000Z0EAC | VISHAY | |
| R2 | 0 OHM JUMPER 0603 0W1 | CRCW06030000Z0EAC | VISHAY | Not Mounted |
| R4 | 0603 | | | Not Mounted |
| R5 | 0603 | | | Not Mounted |
| R6 | 0603 | | | Not Mounted |
| R9 | 100K OHM 1% 0603 0W1 | CRCW0603100KFKEAC | VISHAY | |
| R10 | 100K OHM 1% 0603 0W1 | CRCW0603100KFKEAC | VISHAY | Not Mounted |
| U1 | RPMH3.3-0.5 or RPMH5.0-0.5 MODULE | RPMH3.3-0.5 or RPM5.0-0.5 | RECOM | 3.3Vout version 5.0Vout version |

continued on next page

Specifications (measured @ Ta= 25°C, full load after warm up unless otherwise stated)

RPMH12-0.5-EVM-1 or RPMH15-0.5-EVM-1

| Component | Description | Manufacturer Part Number | Manufacturer | Remarks |
|-----------|-------------------------------|----------------------------|--------------|----------------------------------|
| C1 | 1206 | | | Not Mounted |
| C2 | 1210 | | | Not Mounted |
| C3 | 2.2µF 100V X7R 1210 | 12101C225KAT4A | AVX | |
| C4 | 1210 | | | Not Mounted |
| C5 | 4.7µF 100V X7R 1210 | 12101C475K4T2A | AVX | X7S as alternate |
| C6 | 1206 | | | Not Mounted |
| C7 | 22µF 25V X7R 1210 | 12103C226KAT2A | AVX | |
| C8 | 1206 | | | Not Mounted |
| C9 | 1210 | | | Not Mounted |
| C10 | 1206 | | | Not Mounted |
| C11 | 1210 | | | Not Mounted |
| C12 | 4.7µF 100V X7R 1210 | 12101C475K4T2A | AVX | X7S as alternate |
| L1 | 8.8mm x 4.75mm | | | Not Mounted |
| L2 | 1206 | | | Not Mounted |
| L3 | 0805 | | | Not Mounted |
| L4 | FIXED INDUCTOR 12µH 0.8A | RLS-126 | RECOM | |
| L5 | 8.8mm x 4.75mm | | | Not Mounted |
| L6 | 1206 | | | Not Mounted |
| L7 | 0 OHM JUMPER 0805 0W125 | CRCW08050000Z0ECC | VISHAY | Use 0R 0805 |
| L8 | 0603 | | | Not Mounted |
| L9 | 11.68mm x 7.2mm | | | Not Mounted |
| P1 | CONNECTOR | 695402400222 | WURTH | |
| P2 | CONNECTOR | 695402400222 | WURTH | |
| R1 | 0 OHM JUMPER 0603 0W1 | CRCW06030000Z0EAC | VISHAY | |
| R2 | 0 OHM JUMPER 0603 0W1 | CRCW06030000Z0EAC | VISHAY | Not Mounted |
| R4 | 0603 | | | Not Mounted |
| R5 | 0603 | | | Not Mounted |
| R6 | 0603 | | | Not Mounted |
| R9 | 100K OHM 1% 0603 0W1 | CRCW0603100KFKEAC | VISHAY | |
| R10 | 100K OHM 1% 0603 0W1 | CRCW0603100KFKEAC | VISHAY | |
| U1 | RPMH12-0.5, RPMH15-0.5 MODULE | RPMH12-0.5 or RPM15-0.5 | RECOM | 12Vout version 15Vout version |

continued on next page