

Features

Evaluation Module

- Evaluation platform for RPMH-1.5 Power Modules
- Thermal design considerations included
- EMI Class B filter
- Easy evaluation of control, power good, sequencing and sensing functions

RECOM
Evaluation Module

RPMH-1.5-EVM-1

Description

The RPMH-1.5-EVM-1 generates a constant output voltage with an output current up to 1.5A from an external DC source. All the functions of the RPMH-1.5 like trimming, sequencing, control, and sensing can be evaluated. Also the behavior in overload or over temperature can be evaluated easily before it is designed in.

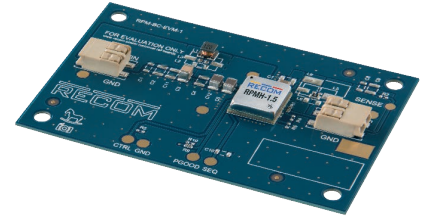

Selection Guide

Part Number	Input Voltage Range [VDC]	Output Voltage nom. [VDC]	Output Current max. [A]
RPMH3.3-1.5-EVM-1	5 - 60	3.3	1.5
RPMH5.0-1.5-EVM-1	7 - 60	5	1.5
RPMH12-1.5-EVM-1	14 - 60	12	1.5
RPMH15-1.5-EVM-1	17 - 60	15	1.5
RPMH24-1.5-EVM-1	26 - 60	24	1.5

Quick Start Guide

- 1) Connect P1 to power supply (observe correct polarity!)
- 2) Connect P2 to a Load
- 3) Connect sense to the required potential
The sense preset is via R1 directly at the power module, so the preset voltage is very accurate at the output of the RPMH-1.5. To equalize ohmic losses of the filter, remove the resistor at R1, and solder a 0 Ω resistor at R2.
- 4) Disable the device via R5
The device is preset as normally on. It can be disabled by pulling the CTRL pad to GND. Short R5 to disable the device.

Specifications (measured @ Ta= 25°C, full load after warm up unless otherwise stated)

Component Placement

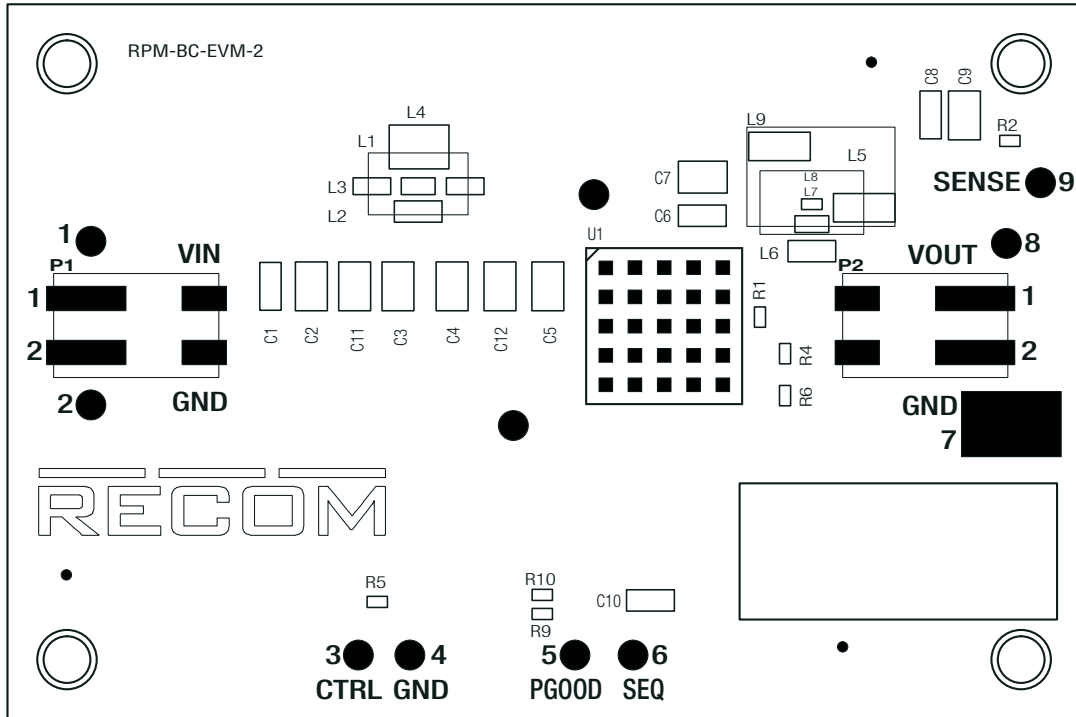

Connector Description

P1

Pin	Name	Description
1	V _{in}	Positive Output Voltage (observe correct polarity!)
2	GND	Common GND

P2

Pin	Name	Description
1	V _{out}	Positive Output Voltage
2	GND	Common GND

PADS direct connection

Pin	Name	Description
1	V _{in}	Positive Input Voltage
2	GND	Common GND
3	CTRL	CTRL Pin (leave open if not used)
4	GND	Common GND
5	PGOOD	Power good signal
6	SEQ	Not used
7	GND	Common GND, can connect oscilloscope GND for measurement
8	V _{out}	Positive Output Voltage
9	SENSE	Output Voltage Sense Pin (leave open if not used)

Specifications (measured @ Ta= 25°C, full load after warm up unless otherwise stated)

Schematic

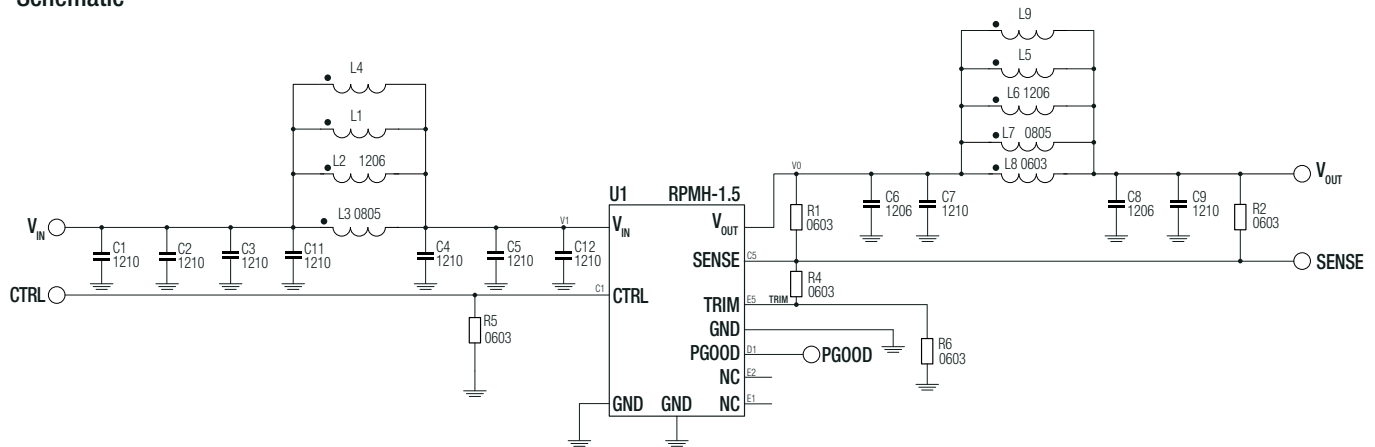

Notes:

Note1: Not all components are populated. See the BOM for all EVM variants.

Description

U1: RPMH-1.5 power module.

C1,C2,C3,C11,L1,L2,L3,L4,C4,C5,C12: allow placement of various sized components to test input filter design. The populated filter is designed to meet EN55032 class B.

C6,C7,L5,L6,L7, C8,C9: allow placement of various sized components to test output filter design. The populated filter is designed to meet EN55032 class B.

R5: connect 0Ω resistor to disable the module. This resistor is not populated.

R9: optional, this resistor is not populated. PGOOD is internally pulled up to 5V. This is for output power good signal. Refer to [RPMH-1.5 datasheet](#) for more information.

R10: optional, this resistor is not populated. Refer to [RPMH-1.5 datasheet](#) for more information.

R1: populated 0Ω resistor for direct output voltage measurement. If sense is desired at a different location, for example after the filter or directly at the load, desolder R1, and connect sense to the new measurement point.

R2: sense point for output voltage after the filter. To set sense point here, remove R1 and solder a 0Ω resistor at R2.

R4 and R6: trim the output voltage. Refer to „**OUTPUT VOLTAGE TRIMMING**“.

OUTPUT VOLTAGE TRIMMING

The RPMH-series offers the feature of trimming the output voltage over a range **between -20% to +10% for lower output voltages and from -40% to +10% for higher output voltages**. This can be done by using external trim resistors. The values for the trim resistors in trim tables are according to standard E96 values; therefore, the specified voltage may slightly vary.

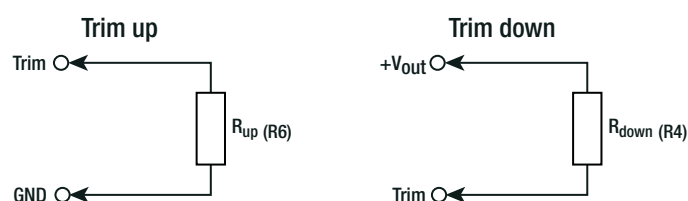

continued on next page

Specifications (measured @ Ta= 25°C, full load after warm up unless otherwise stated)

Calculation:

$V_{out_{nom}}$ = nominal output voltage [VDC]
 $V_{out_{set}}$ = trimmed output voltage [VDC]
 R_{up} = trim up resistor [kΩ]
 R_{down} = trim down resistor [kΩ]
 R_{HI}, R_{LO} = internal resistors [kΩ]

$V_{out_{nom}}$	R_{HI}	R_{LO}
3.3VDC	100kΩ	43k2Ω
5VDC	100kΩ	24k9Ω
12VDC	100kΩ	9k09Ω
15VDC	100kΩ	7k15Ω
24VDC	100kΩ	4k32Ω

$$R_{up} = \frac{R_{HI} \times R_{LO} \times V_{out_{nom}}}{(V_{out_{set}} - V_{out_{nom}}) \times (R_{HI} + R_{LO})}$$

$$R_{down} = R_{HI} \times \left[\frac{(V_{out_{set}} - V_{out_{nom}}) \times R_{LO} + V_{out_{set}} \times R_{HI}}{(V_{out_{nom}} - V_{out_{set}}) \times (R_{HI} + R_{LO})} \right]$$

Practical Example RPMH3.3-1.5, trim up

$V_{out_{set}} = 3.63VDC$

$$R_{up} = \frac{100k \times 43k2 \times 3.3}{(3.63 - 3.3) \times (100k + 43k2)} = \underline{\underline{301k\Omega}}$$

R_{up} according to E96 \approx 301kΩ

Practical Example RPMH3.3-1.5, trim down

$V_{out_{set}} = 2.64VDC$

$$R_{down} = 100k \times \left[\frac{(2.64 - 3.3) \times 43k2 + 2.64 \times 100k}{(3.3 - 2.64) \times (100k + 43k2)} \right] = \underline{\underline{249 k\Omega}}$$

R_{down} according to E96 \approx 249kΩ

RPMH3.3-1.5

Trim up

$V_{out_{set}} =$	3.4V	3.45V	3.5V	3.63V	[VDC]
R_{up} (E96) \approx	1M	665k	499k	301k	[Ω]

Trim down

$V_{out_{set}} =$	3.1V	3V	2.8V	2.64V	[VDC]
R_{down} (E96) \approx	1M05	665k	357k	249k	[Ω]

RPMH5.0-1.5

Trim up

$V_{out_{set}} =$	5.1V	5.3V	5.5V	[VDC]
R_{up} (E96) \approx	1M	332k	200k	[Ω]

Trim down

$V_{out_{set}} =$	4.7V	4.5V	4.3V	4V	[VDC]
R_{down} (E96) \approx	1M24	698k	475k	301k	[Ω]

RPMH12-1.5

Trim up

$V_{out_{set}} =$	12.4	12.6	12.8	13	13.2	[VDC]
R_{up} (E96) \approx	249k	165k	124k	100k	82k5	[Ω]

Trim down

$V_{out_{set}} =$	10	9.6	9	8.5	8	7.7	7.2	[VDC]
R_{down} (E96) \approx	453k	357k	267k	215k	174k	154k	130k	[Ω]

continued on next page

Specifications (measured @ Ta= 25°C, full load after warm up unless otherwise stated)

RPMH15-1.5

Trim up

V _{outset} =	15.5	15.7	15.9	16.1	16.3	16.5	[VDC]
R _{up} (E96) ≈	200k	143k	110k	88k7	76k8	66k5	[Ω]

Trim down

V _{outset} =	14.5	14	13.5	13	[VDC]
R _{down} (E96) ≈	2M67	1M30	825k	604k	[Ω]

RPMH24-1.5

Trim up

V _{outset} =	24.5	25	25.5	26	26.5	27	28	[VDC]
R _{up} (E96) ≈	200k	100k	66k5	49k9	40k2	33k2	24k9	[Ω]

Trim down

V _{outset} =	20.1	19.6	18	17.6	17	16.5	[VDC]
R _{down} (E96) ≈	487k	422k	280k	261k	226k	205k	[Ω]

DIMENSION AND PHYSICAL CHARACTERISTICS

Parameter	Type	Value
Dimension (LxWxH)		85.0 x 55.0 x 5.9mm
Weight		21g typ.

Layout

Top Layer

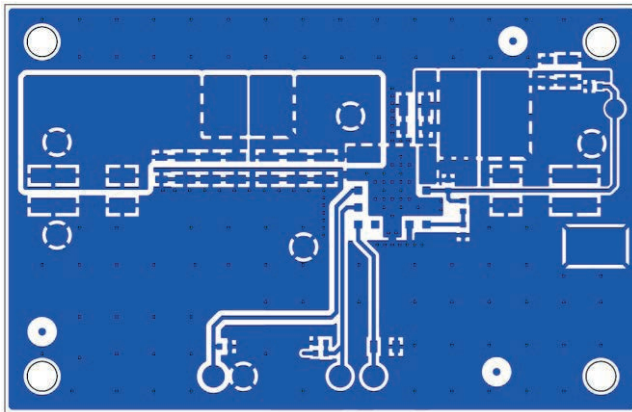

Layer 2 (GND)

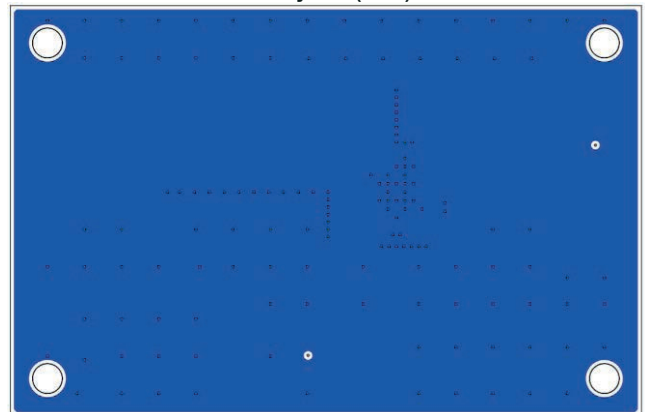

Layer 3 (Single)

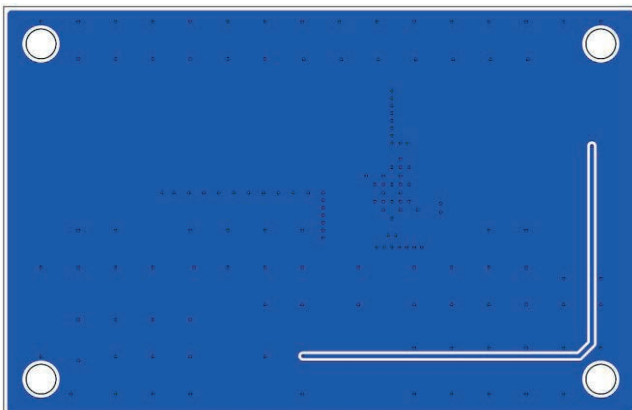

Bottom (GND)

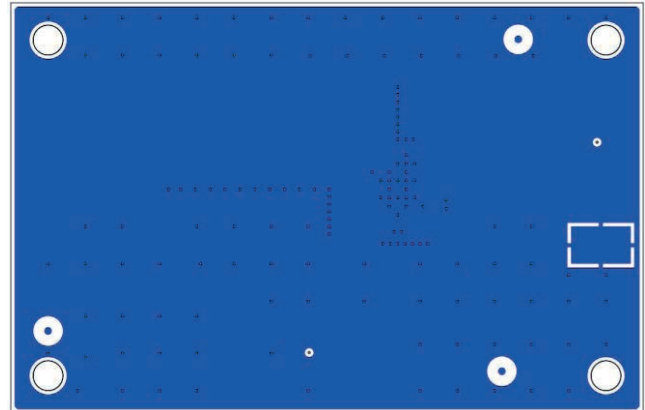

Notes:

Note2: Visit www.recom-power.com/eval-ref-boards to download the Gerber files.

Specifications (measured @ Ta= 25°C, full load after warm up unless otherwise stated)

BOM

RPMH3.3-1.5-EVM-1

Component	Description	Manufacturer Part Number	Manufacturer	Remarks
C1	1206			Not Mounted
C2	1210			Not Mounted
C3	3.3µF 100V X7R 1210	AVX	12101C335K4T2A	X7S as alternate
C4	1210			Not Mounted
C5	2.2µF 100V X7R 1206	AVX	12101C225KAT4A	X7S as alternate
C6	1206			Not Mounted
C7	1210			Not Mounted
C8	1206			Not Mounted
C9	1210			Not Mounted
C10	1206			Not Mounted
C11	1210			Not Mounted
C12	1210			Not Mounted
L1	8.8mm x 4.75mm			Not Mounted
L2	1206			Not Mounted
L3	FIXED INDUCTOR 4.7µH 1.5A	MURATA	DFE252012F-4R7M=P2	
L4	4.5mm x 3.2mm			Not Mounted
L5	8.8mm x 4.75mm			Not Mounted
L6	1206			Not Mounted
L7	0Ω JUMPER 0805 0W125	VISHAY	CRCW08050000Z0ECC	Use 0R 0805
L8	0603			Not Mounted
L9	11.68mm x 7.2mm			Not Mounted
P1	CONNECTOR	WURTH	695402400222	
P2	CONNECTOR	WURTH	695402400222	
R1	0Ω JUMPER 0603 0W1	VISHAY	CRCW06030000Z0EAC	
R2	0603			Not Mounted
R4	0603			Not Mounted
R5	0603			Not Mounted
R6	0603			Not Mounted
R9	0603			Not Mounted
R10	0603			Not Mounted
U1	RPMH3.3-1.5 MODULE	RECOM	RPMH3.3-1.5	

continued on next page

Specifications (measured @ Ta= 25°C, full load after warm up unless otherwise stated)

RPMH5.0-1.5-EVM-1

Component	Description	Manufacturer Part Number	Manufacturer	Remarks
C1	1206			Not Mounted
C2	1210			Not Mounted
C3	3.3 μ F 100V X7R 1210	AVX	12101C335K4T2A	X7S as alternate
C4	1210			Not Mounted
C5	2.2 μ F 100V X7R 1206	AVX	12101C225KAT4A	X7S as alternate
C6	1206			Not Mounted
C7	1210			Not Mounted
C8	1206			Not Mounted
C9	1210			Not Mounted
C10	1206			Not Mounted
C11	1210			Not Mounted
C12	1210			Not Mounted
L1	8.8mm x 4.75mm			Not Mounted
L2	1206			Not Mounted
L3	FIXED INDUCTOR 4.7 μ H 1.5A	MURATA	DFE252012F-4R7M=P2	
L4	4.5mm x 3.2mm			Not Mounted
L5	8.8mm x 4.75mm			Not Mounted
L6	1206			Not Mounted
L7	0 Ω JUMPER 0805 0W125	VISHAY	CRCW08050000Z0ECC	Use 0R 0805
L8	0603			Not Mounted
L9	11.68mm x 7.2mm			Not Mounted
P1	CONNECTOR	WURTH	695402400222	
P2	CONNECTOR	WURTH	695402400222	
R1	0 Ω JUMPER 0603 0W1	VISHAY	CRCW06030000Z0EAC	
R2	0603			Not Mounted
R4	0603			Not Mounted
R5	0603			Not Mounted
R6	0603			Not Mounted
R9	0603			Not Mounted
R10	0603			Not Mounted
U1	RPMH5.0-1.5 MODULE	RECOM	RPMH5.0-1.5	

continued on next page

Specifications (measured @ Ta= 25°C, full load after warm up unless otherwise stated)

RPMH12-1.5-EVM-1

Component	Description	Manufacturer Part Number	Manufacturer	Remarks
C1	1206			Not Mounted
C2	1210			Not Mounted
C3	3.3μF 100V X7R 1210	AVX	12101C335K4T2A	X7S as alternate
C4	1210			Not Mounted
C5	2.2μF 100V X7R 1206	AVX	12101C225KAT4A	X7S as alternate
C6	1206			Not Mounted
C7	10μF 50V X7R 1210	AVX	2105C106KAT2A	X7S as alternate
C8	1206			Not Mounted
C9	10μF 50V X7R 1210	AVX	2105C106KAT2A	X7S as alternate
C10	1206			Not Mounted
C11	1210			Not Mounted
C12	1210			Not Mounted
L1	8.8mm x 4.75mm			Not Mounted
L2	FIXED INDUCTOR 5.6μH 1.7A	PULSE ELECTRONICS	PA4547.562NLT	
L3	0805			Not Mounted
L4	4.5mm x 3.2mm			Not Mounted
L5	8.8mm x 4.75mm			Not Mounted
L6	1206			Not Mounted
L7	0Ω JUMPER 0805 0W125	VISHAY	CRCW08050000Z0ECC	Use 0R 0805
L8	0603			Not Mounted
L9	11.68mm x 7.2mm			Not Mounted
P1	CONNECTOR	WURTH	695402400222	
P2	CONNECTOR	WURTH	695402400222	
R1	0Ω JUMPER 0603 0W1	VISHAY	CRCW06030000Z0EAC	
R2	0603			Not Mounted
R4	0603			Not Mounted
R5	0603			Not Mounted
R6	0603			Not Mounted
R9	0603			Not Mounted
R10	0603			Not Mounted
U1	RPMH12-1.5 MODULE	RECOM	RPMH12-1.5	

continued on next page

Specifications (measured @ Ta= 25°C, full load after warm up unless otherwise stated)

RPMH15-1.5-EVM-1

Component	Description	Manufacturer Part Number	Manufacturer	Remarks
C1	1206			Not Mounted
C2	1210			Not Mounted
C3	3.3μF 100V X7R 1210	AVX	12101C335K4T2A	X7S as alternate
C4	1210			Not Mounted
C5	3.3μF 100V X7R 1210	AVX	12101C335K4T2A	X7S as alternate
C6	1206			Not Mounted
C7	10μF 50V X7R 1210	AVX	2105C106KAT2A	X7S as alternate
C8	1206			Not Mounted
C9	10μF 50V X7R 1210	AVX	2105C106KAT2A	X7S as alternate
C10	1206			Not Mounted
C11	1210			Not Mounted
C12	1210			Not Mounted
L1	8.8mm x 4.75mm			Not Mounted
L2	1206			Not Mounted
L3	0805			Not Mounted
L4	FIXED INDUCTOR 10μH 1.5A	TDK	SPM4015T-100M-LR	
L5	8.8mm x 4.75mm			Not Mounted
L6	1206			Not Mounted
L7	0Ω JUMPER 0805 0W125	VISHAY	CRCW08050000Z0ECC	Use 0R 0805
L8	0603			Not Mounted
L9	11.68mm x 7.2mm			Not Mounted
P1	CONNECTOR	WURTH	695402400222	
P2	CONNECTOR	WURTH	695402400222	
R1	0Ω JUMPER 0603 0W1	VISHAY	CRCW06030000Z0EAC	
R2	0603			Not Mounted
R4	0603			Not Mounted
R5	0603			Not Mounted
R6	0603			Not Mounted
R9	0603			Not Mounted
R10	0603			Not Mounted
U1	RPMH15-1.5 MODULE	RECOM	RPMH15-1.5	

continued on next page