

**SINGLE-PHASE GLASS PASSIVATED
SILICON BRIDGE RECTIFIER**
VOLTAGE RANGE 50 to 1000 Volts CURRENT 35 Amperes

FEATURES

- * Low leakage
- * Low forward voltage
- * Surge overload rating : 300 amperes peak
- * Mounting position: Any
- * Ideal for printed circuit boards
- * High forward surge current capability

MECHANICAL DATA

- * Epoxy: Device has UL flammability classification 94V-O
- * UL list the recognized component directory, file #E252754

MAXIMUM RATINGS AND ELECTRICAL CHARACTERISTICS

Ratings at 25 °C ambient temperature unless otherwise specified.
resistive or inductive load.

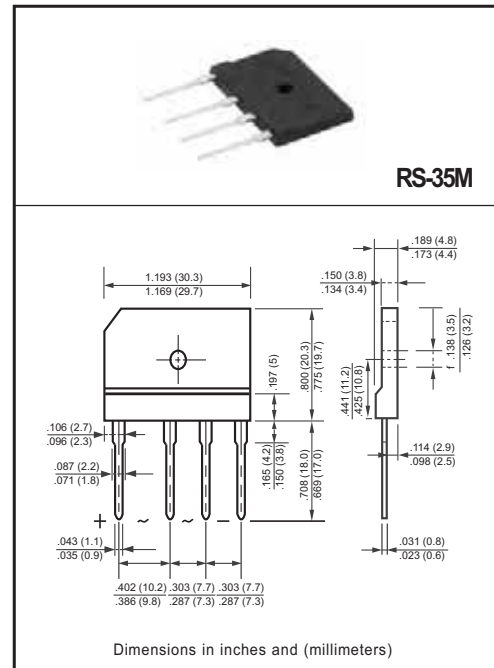

MAXIMUM RATINGS (@ TA=25 °C unless otherwise noted)

RATINGS	SYMBOL	RS3501M	RS3502M	RS3503M	RS3504M	RS3505M	RS3506M	RS3507M	UNITS
Maximum Recurrent Peak Reverse Voltage	V _{RRM}	50	100	200	400	600	800	1000	Volts
Maximum RMS Voltage	V _{RMS}	35	70	140	280	420	560	700	Volts
Maximum DC Blocking Voltage	V _{DC}	50	100	200	400	600	800	1000	Volts
Maximum RSM Blocking Voltage	V _{RSM}	150	200	300	500	700	900	1100	Volts
Maximum Average Forward Rectified Current	I _O	35							Amps
Peak Forward Surge Current 8.3 ms single half sine-wave superimposed on rated load (JEDEC method)	I _{FSM}	400							Amps
Typical Current Squared Time	I _t ²	664							A ² /S
Insulation voltage	V _{ISO}	3000							Volts
Typical Thermal Resistance (Note 1)	R _{θJL}	1.0							°C/W
	R _{θJA}	22							
Operating and Storage Temperature Range	T _J , T _{STG}	-55 to + 150							°C

ELECTRICAL CHARACTERISTICS (@TA=25 °C unless otherwise noted)

CHARACTERISTICS	SYMBOL	RS3501M	RS3502M	RS3503M	RS3504M	RS3505M	RS3506M	RS3507M	UNITS
Maximum Instantaneous Forward Voltage at 17.5A DC	V _F	1.0							Volts
Maximum DC Reverse Current at Rated DC Blocking Voltage	@T _A = 25°C	0.5							uAmps
	@T _A = 150°C	500							

NOTES : 1. Thermal Resistance : Heat-sink case mounted or if PCB mounted.
2. "ROHS compliant".

2019-06
REV: J

RATING AND CHARACTERISTICS CURVES (RS3501M THRU RS3507M)

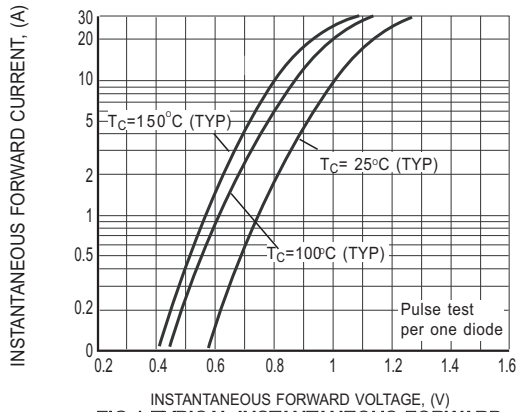

FIG.1 TYPICAL INSTANTANEOUS FORWARD CHARACTERISTICS

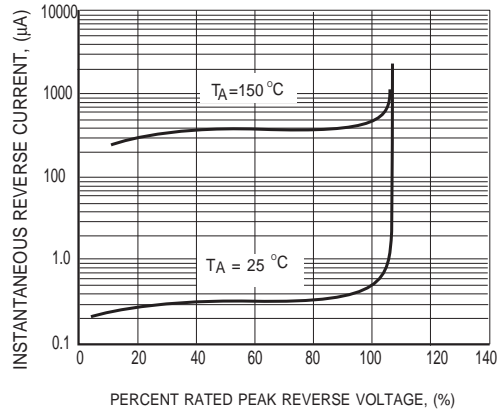

FIG.2 MAXIMUM REVERSE CHARACTERISTICS

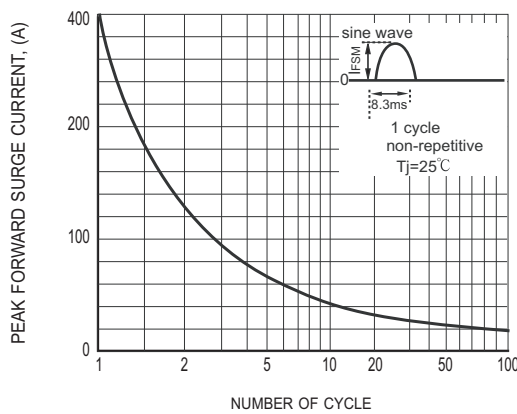

FIG.3 SURGE FORWARD CURRENT CAPABILITY

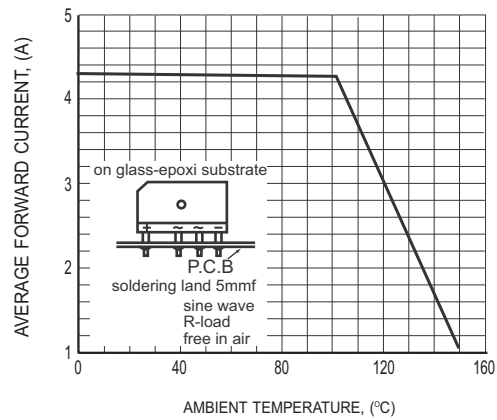

FIG.4 TYPICAL FORWARD CURRENT DERATING CURVE

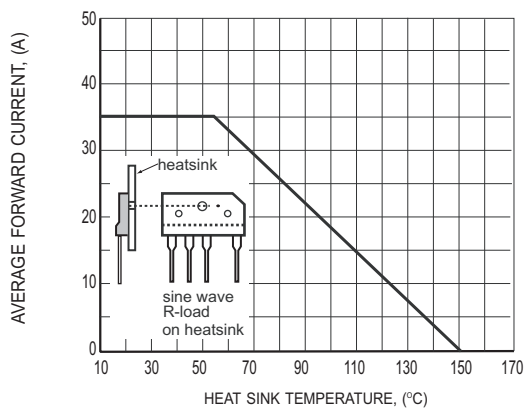

FIG.5 TYPICAL FORWARD CURRENT DERATING CURVE

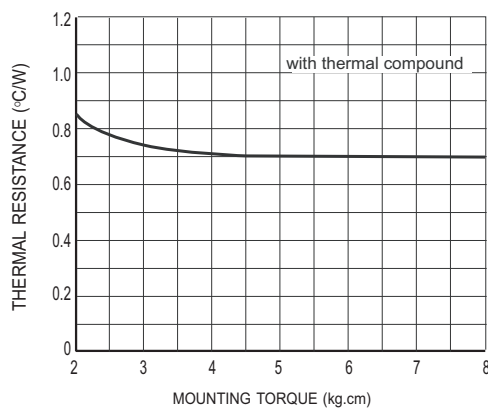
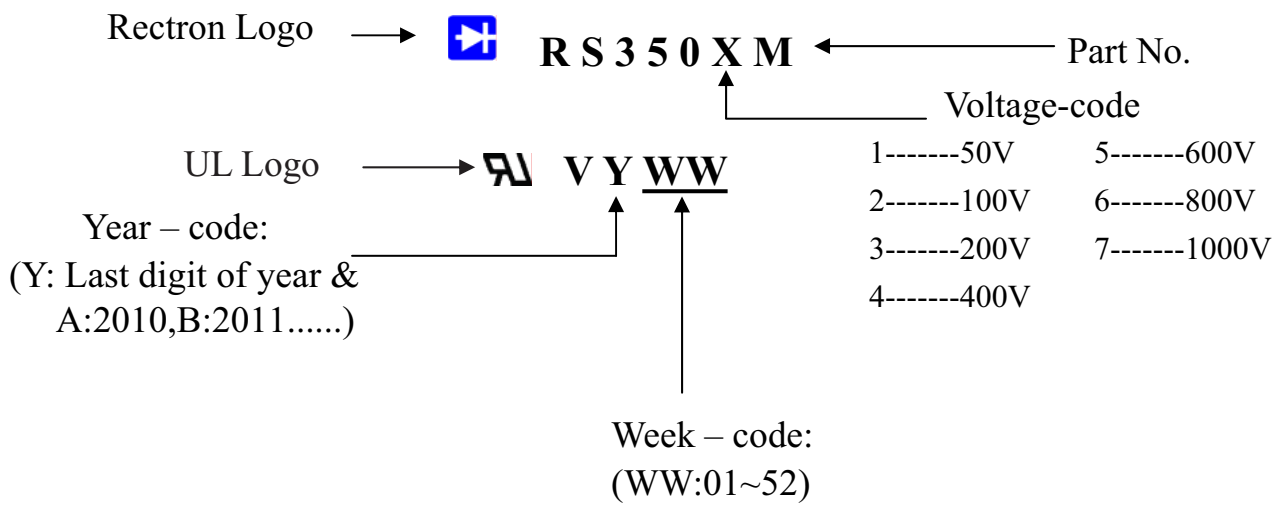

FIG.6 CONTACT THERMAL RESISTANCE fcf

Marking Description



PACKAGING OF DIODE AND BRIDGE RECTIFIERS

TUBE PACK

PACKAGE	PACKING CODE	EA PER BOX	INNER BOX SIZE (mm)	CARTON SIZE (mm)	EA PER CARTON	WEIGHT(Kg)
RS-35M	-C	600	490*135*110	510*293*131	1,200	13.12

