

RS5AC-HF Thru. RS5MC-HF

Reverse Voltage: 50 to 1000 Volts

Forward Current: 5 Amp

RoHS Device

Halogen Free

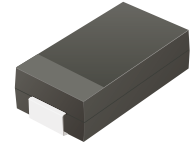

Features

- For surface mounted applications.
- Low profile package.
- Glass passivated chip junction.
- Easy to pick and place.
- Fast reverse recovery time.

Mechanical data

- Case: SMC
- Terminals: Solderable per MIL-STD-750, method 2026.

Circuit Diagram

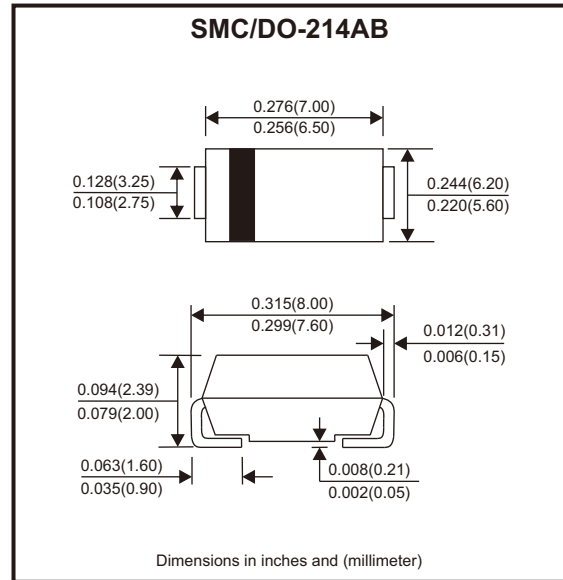

Maximum Ratings and Electrical Characteristics

Ratings at 25°C ambient temperature unless otherwise specified.
Single phase, half wave, 60Hz resistive or inductive load, for capacitive load, derate by 20%

Parameter	Symbols	RS5AC -HF	RS5BC -HF	RS5DC -HF	RS5GC -HF	RS5JC -HF	RS5KC -HF	RS5MC -HF	Units
Maximum repetitive peak reverse voltage	V _{RRM}	50	100	200	400	600	800	1000	V
Maximum RMS voltage	V _{RMS}	35	70	140	280	420	560	700	V
Maximum DC blocking voltage	V _{DC}	50	100	200	400	600	800	1000	V
Maximum average forward rectified current	I _{F(AV)}	5							A
Peak forward surge current, 8.3ms single half sine-wave superimposed on rated load	I _{FSM}	120							A
Max. forward voltage at 5A	V _F	1.3							V
Maximum DC reverse current at rated DC blocking voltage	I _R	5 100							μA
Typical junction capacitance at V _R = 4V, f = 1MHz	C _j	50							pF
Maximum reverse recovery time (Note 1)	t _{rr}	150				250	500		ns
Typical thermal resistance (Note 2)	R _{θJA} R _{θJC}	35 13							°C/W
Operating and storage temperature range	T _j , T _{stg}	-55 ~ +150							°C

Notes: 1. Measured with I_F = 0.5A, I_R = 1A, I_{rr} = 0.25A.
2. P.C.B. mounted with 2.0" x 2.0" (5 x 5 cm) copper pad areas.

Company reserves the right to improve product design, functions and reliability without notice.

REV:A

Rating and Characteristic Curves (RS5AC-HF Thru. RS5MC-HF)

Fig.1 - Forward Current Derating Curve

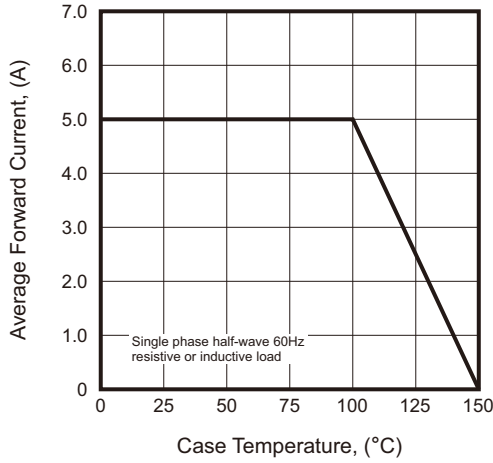

Fig.2 - Typical Reverse Characteristics

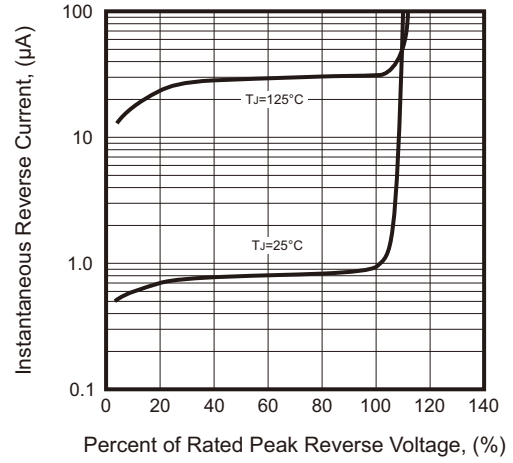

Fig.3 - Typical Instantaneous Forward Characteristic

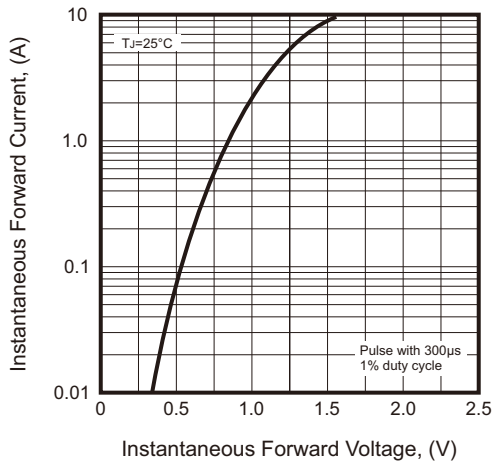

Fig.4 - Typical Junction Capacitance

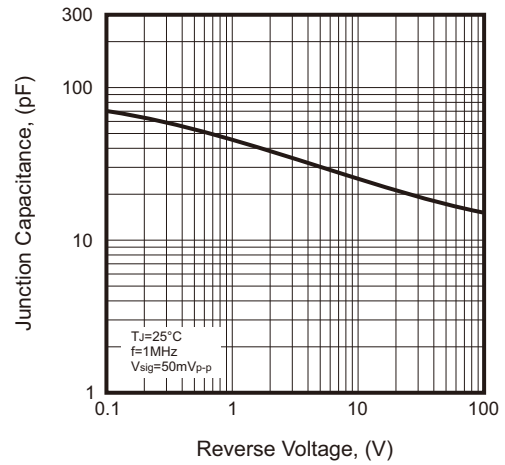
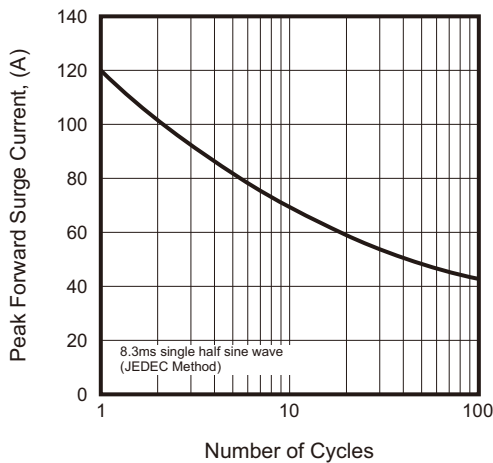
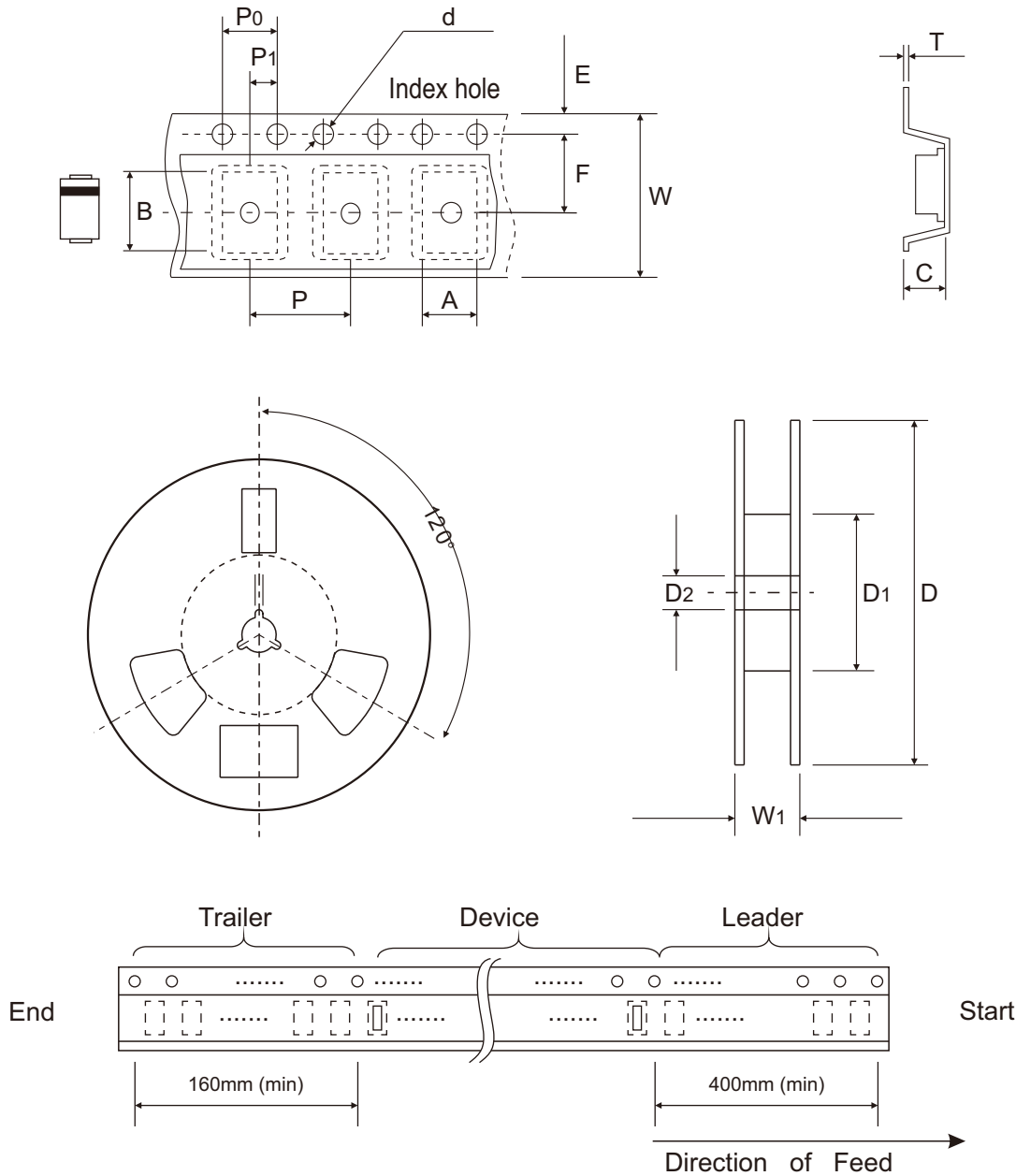

Fig.5 - Maximum Non-Repetitive Peak Forward Surge Current



Company reserves the right to improve product design, functions and reliability without notice.

Reel Taping Specification



DO-214AB (SMC)	SYMBOL	A	B	C	d	D	D1	D2
	(mm)	6.22 ± 0.10	8.31 ± 0.10	2.49 ± 0.10	1.55 ± 0.05	330 ± 2.00	100.00 ± 1.00	13.00 ± 0.20
	(inch)	0.245 ± 0.004	0.327 ± 0.004	0.098 ± 0.004	0.061 ± 0.002	12.992 ± 0.079	3.937 ± 0.039	0.512 ± 0.008

DO-214AB (SMC)	SYMBOL	E	F	P	P0	P1	T	W	W1
	(mm)	1.75 ± 0.10	7.50 ± 0.10	8.00 ± 0.10	4.00 ± 0.10	2.00 ± 0.05	0.28 ± 0.02	16.00 ± 0.30	21.00 + 2.00 - 1.00
	(inch)	0.069 ± 0.004	0.295 ± 0.004	0.315 ± 0.004	0.157 ± 0.004	0.079 ± 0.002	0.011 ± 0.001	0.630 ± 0.012	0.827 + 0.079 - 0.039

Company reserves the right to improve product design, functions and reliability without notice.

REV:A