

**SINGLE-PHASE GLASS PASSIVATED
SILICON BRIDGE RECTIFIER**
VOLTAGE RANGE 50 to 1000 Volts CURRENT 8.0 Amperes

FEATURES

- * Low leakage
- * Low forward voltage
- * Surge overload rating : 200 amperes peak
- * Mounting position: Any
- * Ideal for printed circuit boards
- * High forward surge current capability

MECHANICAL DATA

- * Epoxy: Device has UL flammability classification 94V-O
- * UL list the recognized component directory, file #E94233

MAXIMUM RATINGS AND ELECTRICAL CHARACTERISTICS

Ratings at 25 °C ambient temperature unless otherwise specified.
resistive or inductive load.

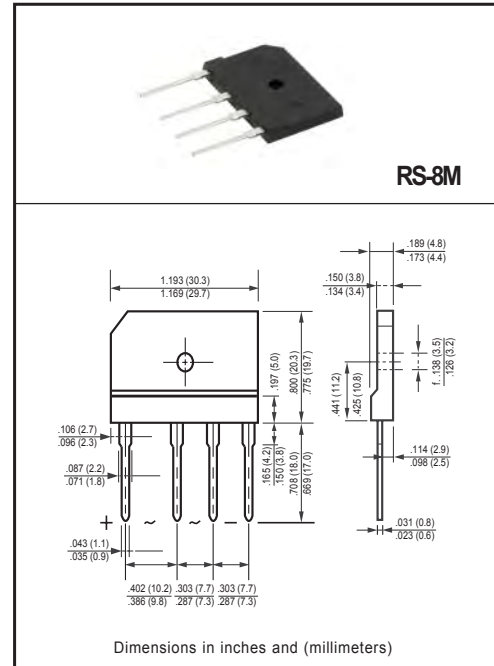

MAXIMUM RATINGS (@ TA=25 °C unless otherwise noted)

RATINGS	SYMBOL	RS801M	RS802M	RS803M	RS804M	RS805M	RS806M	RS807M	UNITS
Maximum Recurrent Peak Reverse Voltage	V _{RRM}	50	100	200	400	600	800	1000	Volts
Maximum RMS Voltage	V _{RMS}	35	70	140	280	420	560	700	Volts
Maximum DC Blocking Voltage	V _{DC}	50	100	200	400	600	800	1000	Volts
Maximum Average Forward Rectified Current at T _C = 75 °C (with heat sink)	I _O	8.0							Amps
Peak Forward Surge Current 8.3 ms single half sine-wave superimposed on rated load (JEDEC method)	I _{FSM}	200							Amps
Current Squared Time	I ² T	165.9							A ² /Sec
RMS isolation voltage from case to lead	V _{iso}	2000							Vac
Typical Thermal Resistance (Note 1)	R _{θJC}	3.4							°C/W
	R _{θJA}	26							
Operating and Storage Temperature Range	T _J , T _{STG}	-55 to + 150							°C

ELECTRICAL CHARACTERISTICS (@TA=25 °C unless otherwise noted)

CHARACTERISTICS	SYMBOL	RS801M	RS802M	RS803M	RS804M	RS805M	RS806M	RS807M	UNITS
Maximum Instantaneous Forward Voltage at 8.0A DC	V _F	1.2							Volts
Maximum DC Reverse Current at Rated DC Blocking Voltage	@T _A = 25°C	5.0							uAmps
	@T _A = 125°C	500							

NOTES : 1. Thermal Resistance : Heat-sink case mounted or if PCB mounted.
2. "Fully ROHS compliant", "100% Sn plating (Pb-free)".

2010-01
REV:A

RATING AND CHARACTERISTICS CURVES (RS801M THRU RS807M)

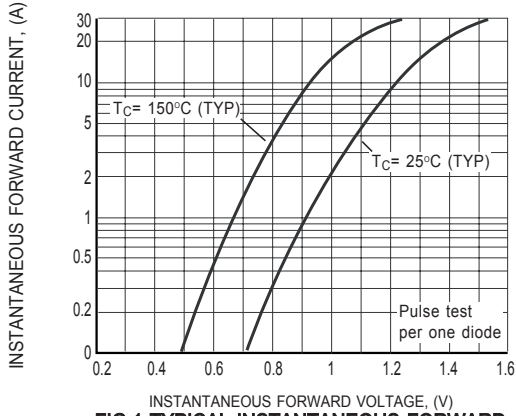

FIG.1 TYPICAL INSTANTANEOUS FORWARD CHARACTERISTICS

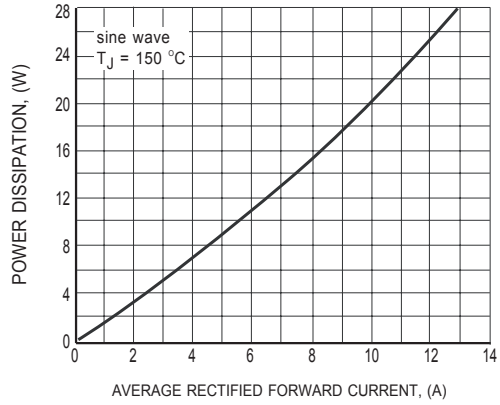

FIG.2 POWER DISSIPATION

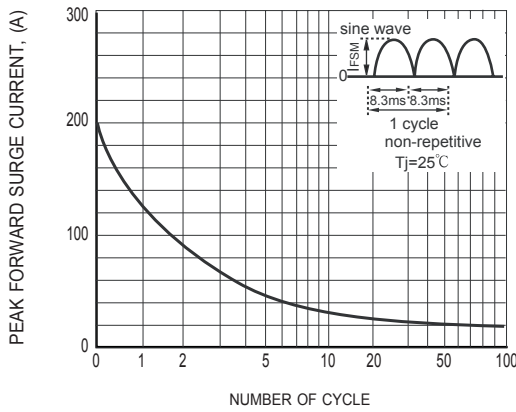

FIG.3 SURGE FORWARD CURRENT CAPABILITY

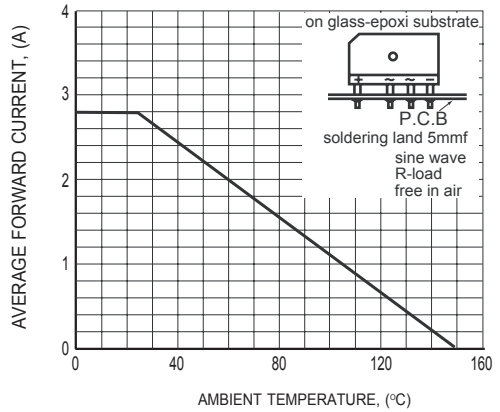

FIG.4 TYPICAL FORWARD CURRENT DERATING CURVE

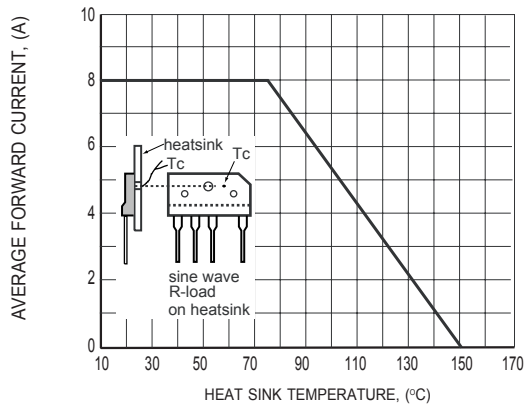
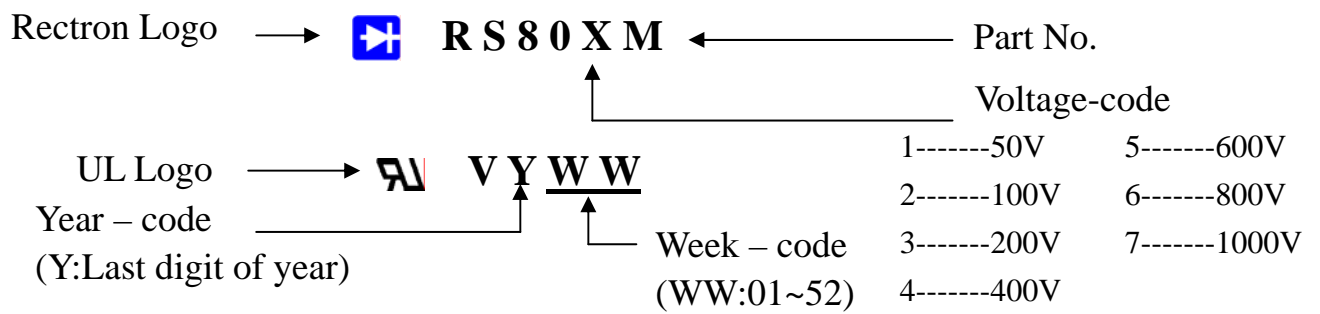

FIG.5 TYPICAL FORWARD CURRENT DERATING CURVE

Marking Description



PACKAGING OF DIODE AND BRIDGE RECTIFIERS

BULK PACK

PACKAGE	PACKING CODE	EA PER BOX	INNER BOX SIZE (mm)	CARTON SIZE (mm)	EA PER CARTON	GROSS WEIGHT(Kg)
RS-8M	-B	300	230*190*46	410*243*157	1,800	13.37

TUBE PACK

PACKAGE	PACKING CODE	EA PER BOX	INNER BOX SIZE (mm)	CARTON SIZE (mm)	EA PER CARTON	WEIGHT(Kg)
RS-8M	-C	600	490*135*110	510*293*131	1,200	13.12