

Datasheet

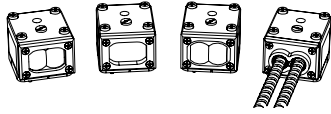

- Modular design for easy exchange of all sensing components and wiring logic
- Interchangeable AC or DC power blocks
- Opposed, polarized and non-polarized retroreflective, diffuse, convergent, fixed-field, and glass or plastic fiber optic sensing modes available
- Interchangeable sensing heads with 90° increment rotation
- Optional output timing logic modules with programming ring
- Quad-ring sealed components resist dirt, dust, and moisture
- Banner Engineering's Alignment Indicating Device (AID) for indication of signal strength
- 15-turn potentiometer for manual adjustment of sensitivity
- Range up to 90 m
- Logic modules offer ON-delay, OFF-delay, ON/OFF-delay, One Shot, and Delayed One Shot output switching logic, depending on model
- Logic modules also offer 0.01 s to 1 s, 0.5 s to 15 s, or 0.1 s to 1 s delay, depending on model
- Power blocks plug into required RWB4 wiring base and feature two LED indicators for output and input status



WARNING:

- **Do not use this device for personnel protection**
- Using this device for personnel protection could result in serious injury or death.
- This device does not include the self-checking redundant circuitry necessary to allow its use in personnel safety applications. A device failure or malfunction can cause either an energized (on) or de-energized (off) output condition.

Overview

Banner MAXI-BEAM® sensors are highly versatile, self-contained, modularized photoelectric sensing controls that are ideally suited to industrial environments. The basic MAXI-BEAM is an ON/OFF switch consisting of three modules (sensor head, power block, and wiring base) and a unique, patented, rotatable programming ring that enables you to program your choice of light or dark operate mode, sensing range, and response time.

MAXI-BEAM sensor heads have an easily-accessible multi-turn sensitivity control for precise adjustment of system gain. Interchangeable sensor heads are rotatable in 90-degree increments and are available in retroreflective, diffuse, opposed, convergent, fixed-field proximity, and fiberoptic sensing modes. Each sensor head also includes Banner's exclusive, patented AID™ circuit (Alignment Indicating Device, US Patent no. 4356393), which features an LED alignment indicator that lights whenever the sensor sees its own modulated light source, and pulses at a rate proportional to the strength of the received light signal.

A wide selection of MAXI-BEAM power block modules is available to interface the sensor head to the circuit to be controlled. The plug-in design of the wiring base enables easy exchange of the entire sensing electronics without disturbing field wiring.

Optional customer-installable logic modules easily convert the basic ON/OFF MAXI-BEAM into either a one-shot or delay logic function control, with several programmable timing ranges for each function.

MAXI-BEAM sensors are ruggedly constructed of molded PBT to NEMA standards 1, 3, 4, 12, and 13, and have interchangeable molded acrylic lenses. Modules simply snap and bolt together, with no interwiring necessary. Module interfaces are o-ring and quad-ring sealed for the ultimate in dust, dirt, and moisture resistance.

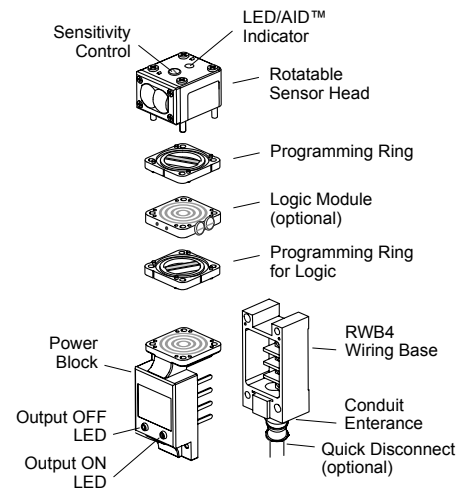

MAXI-BEAM Opposed Mode Emitter (E) and Receiver (R)

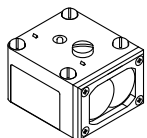

MAXI-BEAM emitters have a visible red "tracer beam". This beam is non-active, and is used as a means of visual alignment during installation. A retroreflector temporarily attached to the receiver lens provides an effective target for the tracer beam during alignment. The narrow beam of the RSBESR/RSBRSR pair is ideal for sensing small parts (effective beam diameter is 3.6 mm (0.14 in)).

One emitter and one receiver are required for use.



Models	Range	Sensing Beam	Effective Beam	Response	Repeatability
RSBE RSBR	90 m (300 feet) in HP (high power) and 2W (2 wire) modes	Infrared, 880 nm with a visible red tracer beam	0.5-inch diameter	HP, 2W mode: 10 ms on/ 5 ms off HS mode: 1 ms on/0.5 ms off SP mode: 0.3 ms on/off	HP, 2W= 1.4 ms HS = 0.1 ms SP = 0.04 ms
RSBESR RSBRSR	4.5 m (15 feet) in HP (high power) and 2W (2 wire) modes	Infrared, 880 nm	N/A	HP, 2W modes: 10 ms on/5 ms off HS mode: 1 ms on/0.5 ms off SP mode: 0.3 ms on/off	HP, 2W= 1.4 ms HS = 0.1 ms SP = 0.04 ms

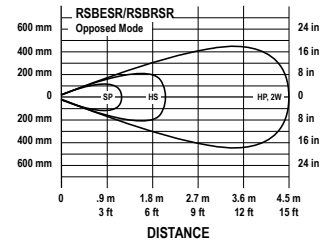
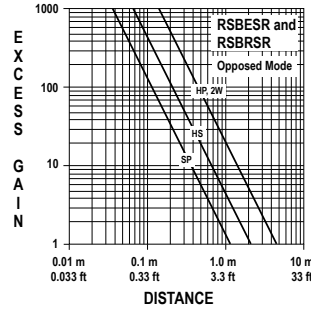
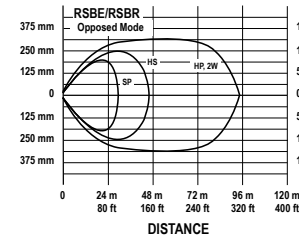
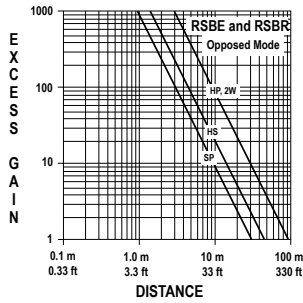

MAXI-BEAM Opposed Fiber Optic Mode (Glass Fibers)

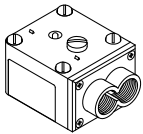

This sensor pair is designed for opposed mode operation using Banner glass fiber optics. Maximum range (HP mode) using L9 lenses is 12 feet. Maximum range using L16F lenses is 50 feet. One emitter and one receiver are required for use.

Models	Range	Sensing Beam	Response	Repeatability
RSBEF RSBRF	See the excess gain curves	Infrared, 880 nm	HP, 2W modes: 10 ms HS mode: 1 ms SP mode: 0.3 ms on/off	HP, 2W = 3.3 ms HS = 0.3 ms SP = 0.1 ms

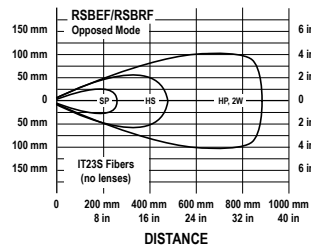
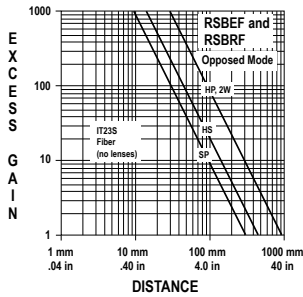

Retroreflective Mode

Models	Range	Sensing Beam	Response	Repeatability
RSBLV	152 mm to 9 m (6 in to 30 ft) in all program modes	Visible red, 650 nm	HP, 2W, SP modes: 4 ms HS mode: 1 ms	HP, 2W, SP = 1.3 ms HS = 0.3 ms
RSBLVAG (anti-glare filter)	305 mm to 4.5 m (1 ft to 15 ft) in all program modes	Visible red, 650 nm, with polarizing filter	HP, 2W, SP modes: 4 ms HS mode: 1 ms	HP, 2W, SP = 1.3 ms HS = 0.3 ms

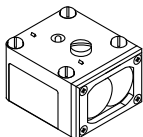

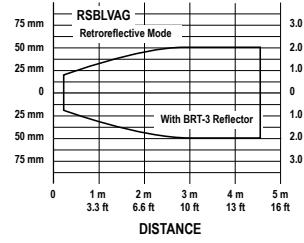
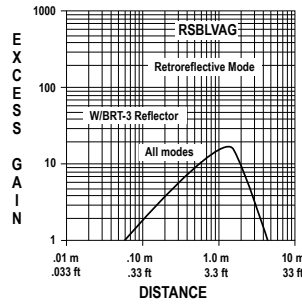
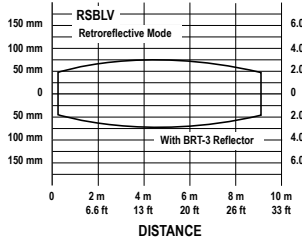
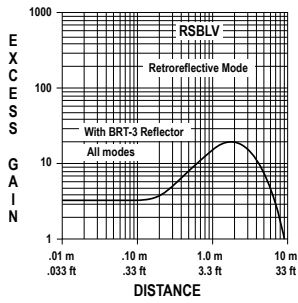

Diffuse Mode

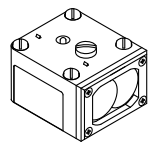
	Models	Range	Sensing Beam	Response	Repeatability
	RSBD	1.5 m (5 ft) in HP and 2W modes	Infrared, 880 nm	HP, 2W modes: 10 ms HS mode: 1 ms SP mode: 0.3 ms	HP, 2W= 3.3 ms HS = 0.3 ms SP = 0.1 ms
	RSBDSR (short range)	762 mm (30 in) in HP and 2W modes	Infrared, 880 nm	HP, 2W modes: 10 ms HS mode: 1 ms SP mode: 0.3 ms	HP, 2W= 3.3 ms HS = 0.3 ms SP = 0.1 ms

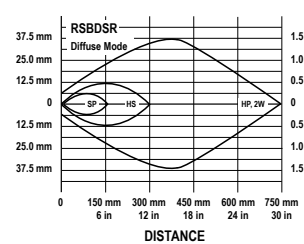
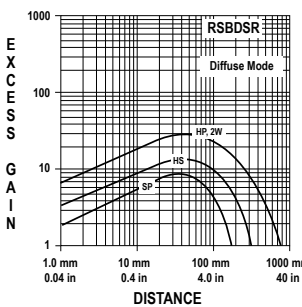
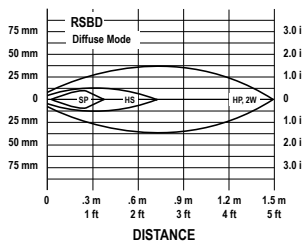
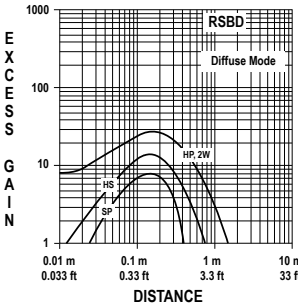

Convergent Mode

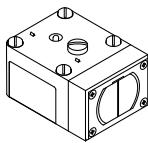

RSBC: Powerful infrared beam reliably senses objects of low reflectivity. Ideal for counting the flow of radiused products at a fixed distance from the sensor.

RSBCV: Powerful visible red beam with precise .06 inch diameter sensing spot. Useful in many high-contrast color registration applications.

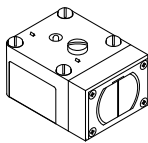
	Models	Focus	Sensing Beam	Response	Repeatability
	RSBC	38 mm (1.5 in)	Infrared, 940 nm	HP, 2W modes: 10 ms HS mode: 1 ms SP mode: 0.3 ms	HP, 2W= 3.3 ms HS = 0.3 ms SP= 0.1 ms
	RSBCV	38 mm (1.5 in) The performance is equal in all program modes	Visible red, 650 nm	HP, 2W, SP modes: 4 ms HS mode: 1 ms	HP, 2W, SP= 1.3 ms HS = 0.3 ms

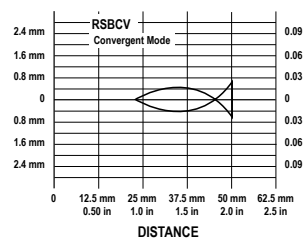
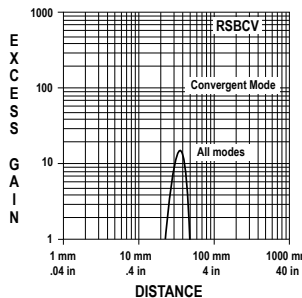
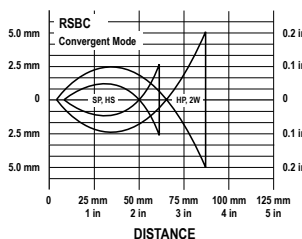
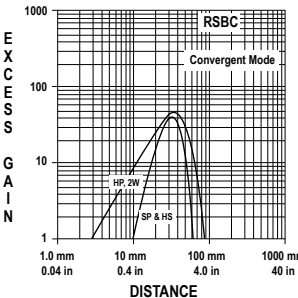

Fixed-Field Mode

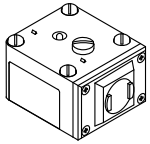

Fixed-field sensor heads have an emitter element and two differently-aimed receiver elements. This creates a high-gain sensing field able to detect objects of low reflectivity, and a sharp far-limit sensing cutoff of 50mm (2 inches) or 100mm (4 inches) which ignores backgrounds beyond cutoff.

These sensors are ideal for detecting a part or surface that is only a fraction of an inch in front of another surface.

RSBFFs may not be used with 2-wire power blocks.

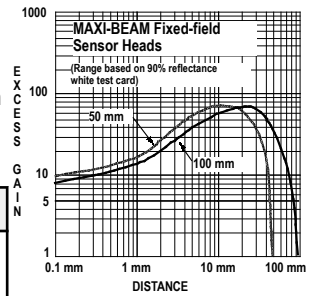

Models	Far Limit Cutoff	Sensing Beam	Response	Repeatability
RSBFF50	50 mm	Infrared, 880 nm	HP mode: 10 ms	HP mode: 3.3 ms
RSBFF100	100 mm			

Fiber Optic Mode (Glass Fibers)

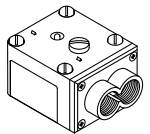

Note: If the retroreflective sensing mode is used in conjunction with the HP or 2W program mode, the GAIN control must be reduced from the factory setting to avoid optical feedback from the lens assembly.

For information on the complete line of Banner glass fiber optics, go to www.bannerengineering.com.

Models	Modes	Range	Sensing Beam	Response	Repeatability
RSBF	Opposed mode	See the excess gain curves	Infrared, 880 nm	HP, 2W modes: 10 ms HS mode: 1 ms SP mode: 0.3 ms	HP, 2W= 3.3 ms HS = 0.3 ms SP = 0.1 ms
	Retroreflective mode				
	Diffuse mode				

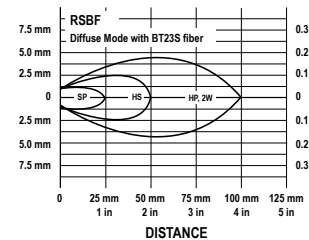
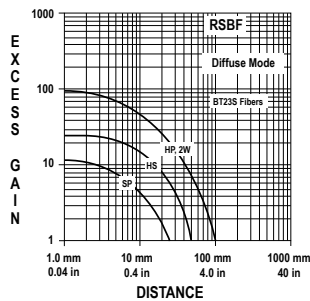
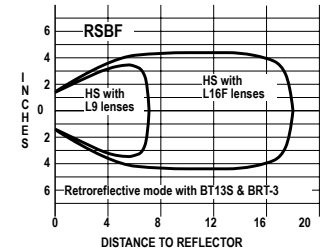
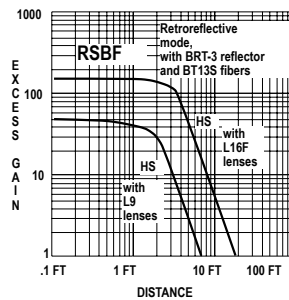
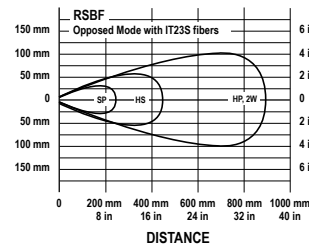
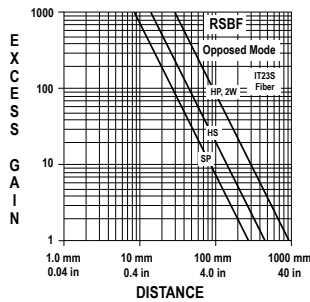

Fiber Optic Mode

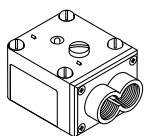

Model RSBFP is a visible-light sensor head designed for use with plastic fiber optics. It is compatible with all standard Banner plastic fiber optic assemblies (see Banner product catalog). In order to function properly, the RSBFP must be programmed for the "HS" response mode. The RSBFP is not for use with glass fiber optics (instead use model RSBF or RSBFV). The model RSBFP will function only when programmed for the "HS" response mode. The model RSBFP will not operate with 2-wire power blocks (models R2PBA and R2PBB).

For information on the complete line of Banner plastic fiber optics, go to www.bannerengineering.com.

Models	Mode	Range	Sensing Beam	Response	Repeatability
RSBFP	Opposed	See the excess gain curves	Visible red, 650 nm	HS mode only, 1 ms on/off	HS = 0.3 ms
	Diffuse				

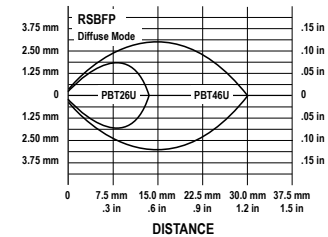
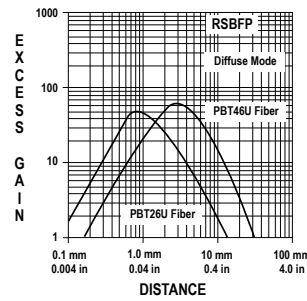
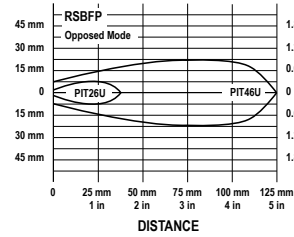
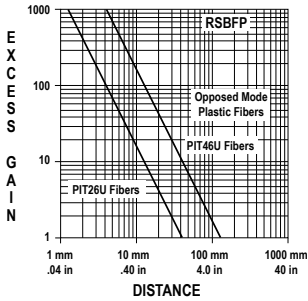

Fiber Optic Models (Glass Fiber, Visible Sensing Beam)

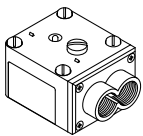

The model RSBFV will function only when programmed for the "HS" response mode. The model RSBFV will not operate with 2-wire power blocks (models R2PBA and R2PBB). Model RSBFV is a visible-light sensor head designed for use with glass fiber optics. It is compatible with all standard Banner glass fiber optic assemblies (see www.bannerengineering.com). To function properly, the RSBFV must be programmed for the "HS" response mode. The RSBFV is not for use with plastic fiber optics (instead use RSBFP). For information on the complete line of Banner glass fiber optics, go to www.bannerengineering.com.

Models	Modes	Range	Sensing Beam	Response	Repeatability
RSBFV	Opposed mode	See the excess gain curves	Visible red, 650 nm	HS mode only, 1 ms on/off	HS = 0.3 ms
	Retroreflective mode				
	Diffuse mode				

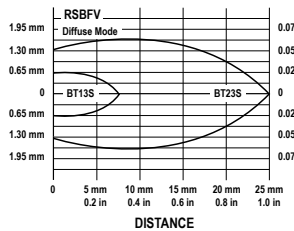
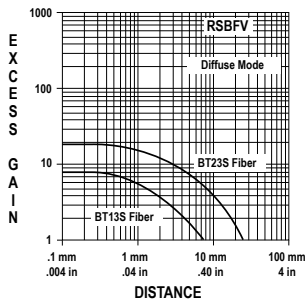
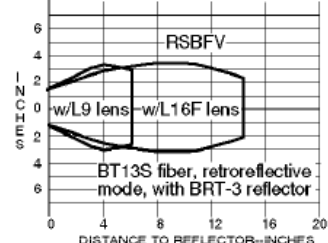
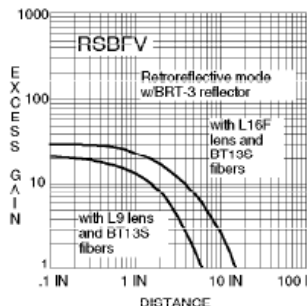
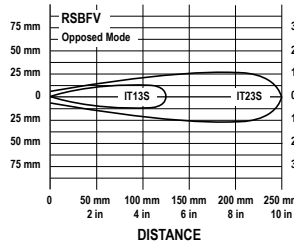
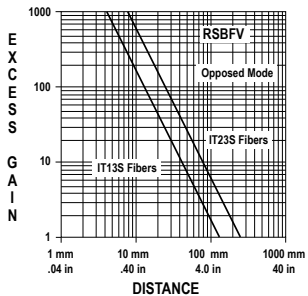

Program the Sensor Head

Program MAXI-BEAM sensor heads for sensor response time (and range) and for LIGHT/DARK operate.

Each sensor head is supplied with a programming ring which attaches below the sensor head by a system of pegs. There are four programming notches around the perimeter of the ring. To program the sensor head, find the notch that will align with the desired program combination (see figure).

Figure 1. Sensor Head and Programming Ring

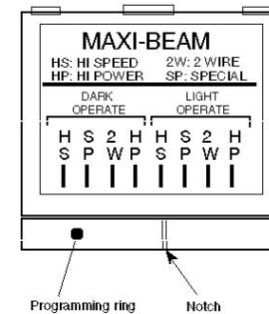

Note: The programming ring may have to be turned upside-down to align the notch with the program.

If LIGHT OPERATE is selected, the MAXI-BEAM output will energize on a dark-to-light transition. If DARK OPERATE is selected, the MAXI BEAM output will energize on a light-to-dark transition. In the illustration, the MAXI-BEAM is set for high speed (HS) operation in the LIGHT OPERATE output state. See the information about each individual sensor head for the response time and range associated with each setting (HP, 2W, HS, SP).



Note: When programming the RSBE, RSBSER, or RSBEF emitter, select the mode that is programmed for the receiver. **EXCEPTION:** If the receiver is programmed for the 2-wire (2W) mode, select high power (HP) on the emitter.

Sensor Head Specifications

Sensitivity Adjustment

15-turn clutched control
Easily accessible, located on top of the sensor head beneath a watertight gasketed screw-cover
Rotate clockwise to increase sensitivity

Alignment Indicator

Red LED on top of sensor head. Banner's exclusive AID™ circuit [¶] lights the LED whenever the sensor sees its own modulated light source, and pulses the LED at a rate proportional to the strength of the received light signal

False Pulse Suppression on Power-up

100 ms delay on power-up

Response Time and Repeatability

See models tables. The response time and repeatability are independent of signal strength.

Certifications



Banner Engineering Europe
Park Lane,
Culliganlaan 2F bus 3, 1831
Diegem, BELGIUM



Turck Banner LTD
Blenheim House, Blenheim
Court, Wickford, Essex
SS11 8YT, Great Britain



Construction

Reinforced molded PBT housing, molded acrylic lenses, o-ring and quad-ring gasketed components. Electronic components are fully epoxy encapsulated.

Environmental Rating

NEMA 1, 3, 4, 12, and 13.

Operating Temperature

-40 °C to +70 °C (-40 °F to +158 °F)

Required Overcurrent Protection



WARNING: Electrical connections must be made by qualified personnel in accordance with local and national electrical codes and regulations.

Overcurrent protection is required to be provided by end product application per the supplied table.

Overcurrent protection may be provided with external fusing or via Current Limiting, Class 2 Power Supply.

Supply wiring leads < 24 AWG shall not be spliced.

For additional product support, go to www.bannerengineering.com.

Supply Wiring (AWG)	Required Overcurrent Protection (Amps)
20	5.0
22	3.0
24	2.0
26	1.0
28	0.8
30	0.5

[¶] US patent no. 4356393

Dimensions

All measurements are listed in millimeters, unless noted otherwise.

Figure 2. Dimensions for the C-CV-D-E-R-LV models

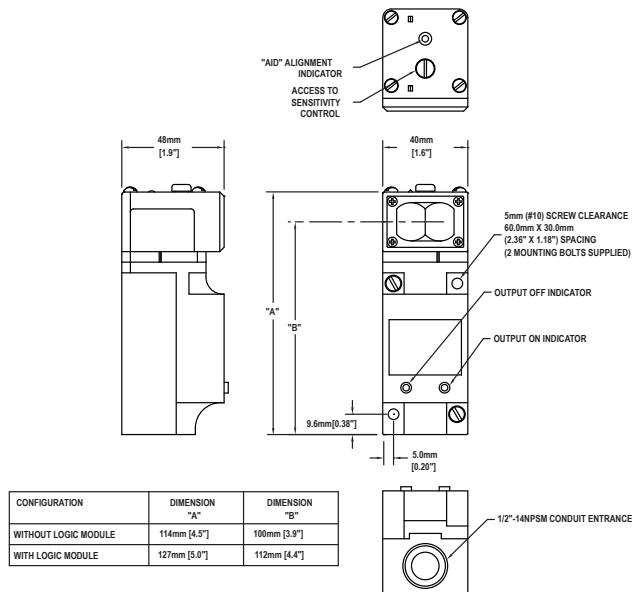

Figure 3. Dimensions for the FF models

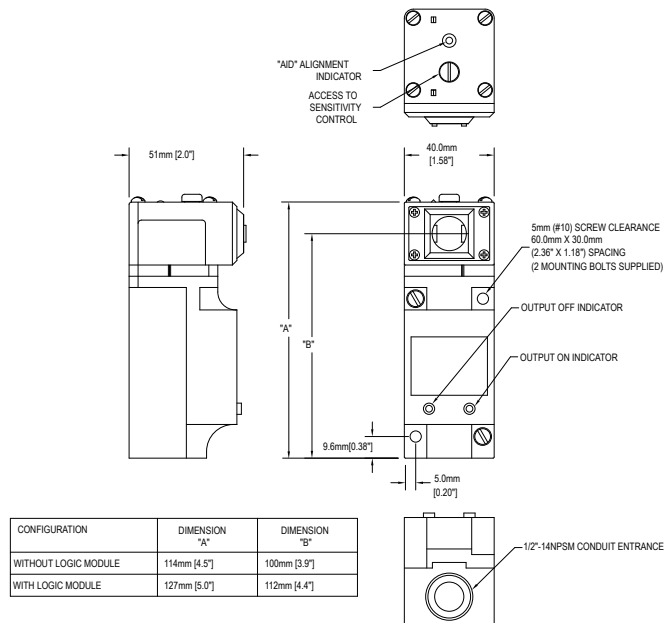
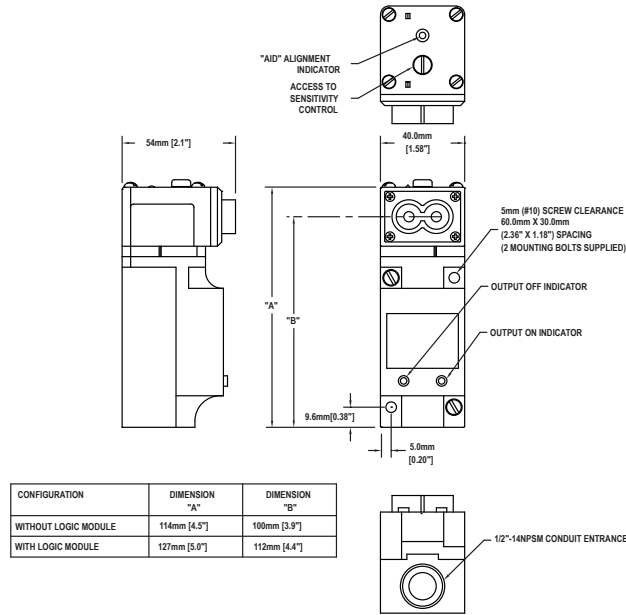

Figure 4. Dimensions for the fiber models



Schematics

Figure 5. Functional Schematic

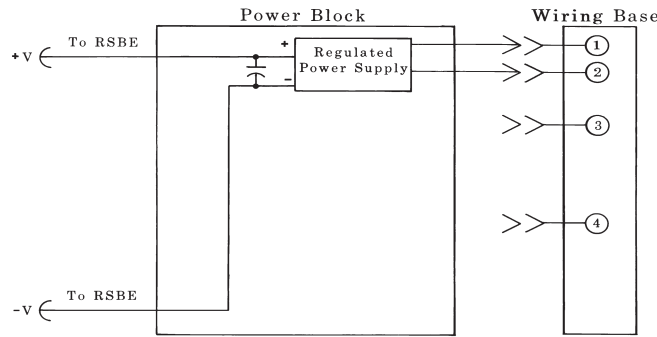
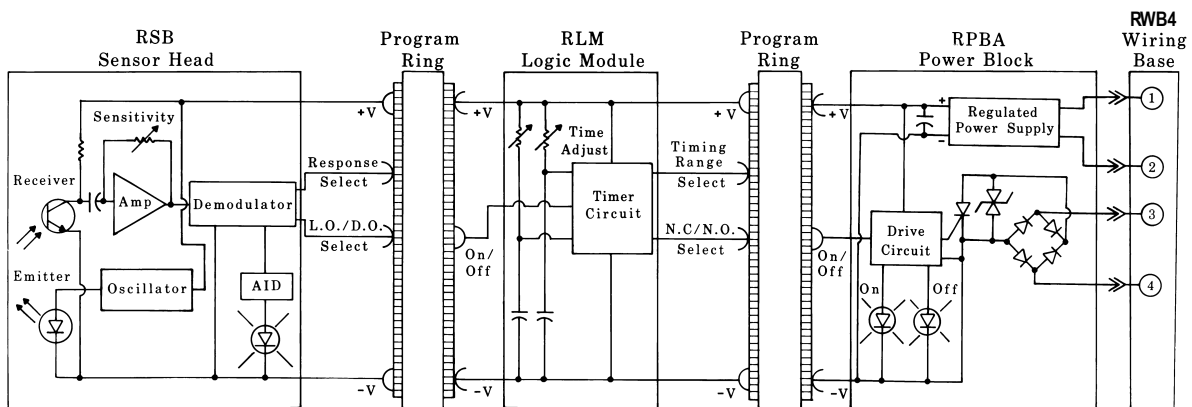

Figure 6. Composite Functional Schematic



Ordering Information

To order a MAXI-BEAM, follow these steps:

1. Select a sensor head module.
2. Select a power block module.
3. Select a wiring base. The wiring base is purchased separately from the power block.
4. Select a logic module (if needed).
5. Select accessories as needed (see www.bannerengineering.com).

Sensor Head Models

Sensor head modules are described in datasheet p/n 03416.

Model	Sensing Type	Range	Model	Sensing Type	Range	
RSBE and RSBR	Opposed mode	91.4 m (300 ft)	RSBF	Infrared fiber optic; for glass fibers	Varies depending on the fiber optics used	
RSBESR and RSBRSR	Opposed mode (short range; narrow beam)	4.6 m (15 ft)	RSBFV	Visible red fiber optic; for glass fibers		
RSBLV	Retroreflective mode	9.1 m (30 ft)	RSBEF and RSBRF	Infrared fiber optic opposed mode; for glass fibers		
RSBLVAG	Retroreflective mode (anti-glare filter)	4.6 m (15 ft)	RSBFP	Visible red fiber optic; for plastic fibers		
RSBD	Long range diffuse proximity mode	1.5 m (5 ft)	RSBFF50	Fixed-field proximity		Sharp far-limit cutoff at 50 mm (2 in)
RSBDSR	Short-range diffuse proximity mode	762 mm (30 in)	RSBFF100			Sharp far-limit cutoff at 100 mm (3.9 in)
RSBCV	Visible red convergent mode,	Focus at: 38.1 mm (1.5 in)				
RSBC	Infrared convergent mode	Focus at: 38.1 mm (1.5 in)				

Power Block Module Models

Power Block modules are described in datasheet p/n 03418.

Model	Supply Voltage	Output Type	Model	Supply Voltage	Output Type
RPBT	10–30 V dc	one sinking and one sourcing solid-state output	RPBB	210 V ac to 250 V ac (50/60 Hz)	SPST solid-state output
RPBT-1		for use with RSBE, ESR, EF emitters (no output circuit)	RPBB-1		use with emitter (no output circuit)
RPBTLM	10–30 V dc Low-profile power block (requires no RWB4 wiring base)		R2PBB , 2-wire operation		SPST solid-state output
RPBA	105–130 V ac (50/60 Hz)	SPST solid-state output	RPBU	12–250 V ac or 12–30 V dc	SPST solid-state output (ac or dc)
RPBA-1		for use with emitter (no output circuit)	RPBR	12–250 V ac (50/60 Hz) or 12–30 V dc	SPST E/M relay output
R2PBA , 2-wire operation		SPST solid-state output	RPBR2	V dc	SPDT E/M relay output

Wiring Base Models

Wiring Base modules are described in datasheet p/n 03418.

Model	Description
RWB4	4-terminal wiring base for all models (except RPBTLM)

Logic Module Models

Logic modules are described in datasheet p/n 03417.

Model	Description
RLM5	On/Off delay (both functions adjustable up to 15 seconds)
RLM8	Delayed One-Shot (delay and pulse adjustable up to 15 seconds)