

# RSGD



## Three phase AC motor soft starter



### Description

RSGD is an extremely compact and easy to use 3-phase soft starter for AC induction motors rated up to 100Arms. The starting parameters can be easily set-up through 3 knobs. The integrated motor overload protection (Class 10) and Modbus communication\*\* result in a higher installation flexibility.

### Applications

RSGD soft starters are the ideal solution for 3-phase fixed speed AC induction motor applications where there is the need to reduce the starting current and/or minimise stresses on the motor during start and stop. The RSGD offers a number of integrated diagnostic functions that can replace additional components inside the electrical panel. Typical applications include: compressors, pumps and fans.

### Main functions

- Soft starting and soft stopping of AC motors.
- Integrated electronic overload protection (Class 10)\*.
- Serial communication (Modbus) over RS485\*\*.

\* RSGD VD210, VX210, VX310C, VX311C models only

\*\* RSGD 75mm models only

### Benefits

- **Easy to use.** The RSGD is equipped with a self-learning algorithm that automatically adjusts the start parameters to optimise the motor starts and stops.
- **Fast installation and set-up.** Only 3 settings are required (FLC, ramp-up and ramp-down).
- **Compact dimensions.** 12 - 45Arms in 45mm wide housing, 55 - 100Arms in 75mm wide housing.
- **Integrated protection.** Diagnostic functions provide additional protection. RSGD is also equipped with an overload protection (Class 10)\*.
- **Torque control during ramp-down.** Smoother deceleration of the load.
- **Complete monitoring.** The RSGD is equipped with a Modbus/RTU communication port by 2-wire RS485 connection\*\*.
- **Guided model selection.** Easy to use selection tool to select the appropriate soft starter model depending on the application type.

## References

### Order code

 RSG D  V

Enter the code entering the corresponding option instead of

| Code                     | Option | Description   | Notes                                     |
|--------------------------|--------|---|---|
| R                        | -      |   |   |
| S                        | -      | Soft starter  |   |
| G                        | -      | General purpose   |   |
| D                        | -      | Dual phase control  |   |
| <input type="checkbox"/> | 40     | 220 – 400 VAC +10% -15% operational voltage (Ue)                                      |   |
|                          | 60     | 220 – 600 VAC +10% -15% operational voltage (Ue)                                      |   |
| <input type="checkbox"/> | 12     | 12 Arms   | Rated operational current @ 40°C          |
|                          | 16     | 16 Arms   |   |
|                          | 25     | 25 Arms   |   |
|                          | 32     | 32 Arms   |   |
|                          | 45     | 45 Arms   |   |
|                          | 55     | 55 Arms   |   |
|                          | 70     | 70 Arms   |   |
|                          | 85     | 85 Arms   |   |
| <input type="checkbox"/> | E0     | 110 - 400 VAC +10% -15% control voltage (Uc)<br>Supply voltage: internally supplied   | RSGD40 only                               |
|                          | F0     | 24 VAC/DC +10% -10% control voltage (Uc)<br>Supply voltage: internally supplied       |   |
|                          | FF     | 24 VAC/DC +10% -10% control/supply voltage<br>Supply voltage: externally supplied     | RSGD60 models from 55Arms to 100Arms only |
|                          | GG     | 100 - 240 VAC +10% -15% control/supply voltage<br>Supply voltage: externally supplied | RSGD60 only                               |
| V                        | -      |   |   |
| <input type="checkbox"/> | D      | No heatsink   | RSGD 45mm only                            |
|                          | X      | With heatsink   |   |
| <input type="checkbox"/> | 2      | 2 relay outputs   | RSGD 45mm only                            |
|                          | 3      | 3 relay outputs   | RSGD 75mm only                            |
| <input type="checkbox"/> | 1      | With integrated motor overload protection (Class 10)                                  |   |
|                          | 0      | Without motor overload protection   | RSGD 45mm only                            |
| <input type="checkbox"/> | 1      | With fan  | RSGD 100 only                             |
|                          | 0      | No fan  |   |
| <input type="checkbox"/> | -      | Without communication   | RSGD 45mm only                            |
|                          | C      | With Modbus communication   | RSGD 75mm only                            |

## Selection guide

| Rated operational current (I <sub>e</sub> ) | Operational voltage: 400VAC        |                                    | Operational voltage: 600VAC          |                                  |
|---|------------------------------------|------------------------------------|--------------------------------------|----------------------------------|
|   | Control voltage 110 - 400 VAC      | Control voltage 24 VAC/DC          | Control/supply voltage 100 - 240 VAC | Control/supply voltage 24 VAC/DC |
| <b>12 Arms</b>                              | RSGD4012E0VD200<br>RSGD4012E0VD210 | RSGD4012F0VD200<br>RSGD4012F0VD210 | RSGD6012GGVD210                      | -                                |
| <b>16 Arms</b>                              | RSGD4016E0VD200<br>RSGD4016E0VD210 | RSGD4016F0VD200<br>RSGD4016F0VD210 | RSGD6016GGVD210                      | -                                |
| <b>25 Arms</b>                              | RSGD4025E0VD200<br>RSGD4025E0VX210 | RSGD4025F0VD200<br>RSGD4025F0VX210 | RSGD6025GGVX210                      | -                                |
| <b>32 Arms</b>                              | RSGD4032E0VD200<br>RSGD4032E0VX210 | RSGD4032F0VD200<br>RSGD4032F0VX210 | RSGD6032GGVX210                      | -                                |
| <b>45 Arms</b>                              | RSGD4045E0VX200<br>RSGD4045E0VX210 | RSGD4045F0VX200<br>RSGD4045F0VX210 | RSGD6045GGVX210                      | -                                |
| <b>55 Arms</b>                              | RSGD4055E0VX310C                   | RSGD4055F0VX310C                   | RSGD6055GGVX310C                     | RSGD6055FFVX310C                 |
| <b>70 Arms</b>                              | RSGD4070E0VX310C                   | RSGD4070F0VX310C                   | RSGD6070GGVX310C                     | RSGD6070FFVX310C                 |
| <b>85 Arms</b>                              | RSGD4085E0VX310C                   | RSGD4085F0VX310C                   | RSGD6085GGVX310C                     | RSGD6085FFVX310C                 |
| <b>100 Arms</b>                             | RSGD40100E0VX311C                  | RSGD40100F0VX311C                  | RSGD60100GGVX311C                    | RSGD60100FFVX311C                |

## Further reading

| Information                   | Where to find it  |
|-------------------------------|---|
| RSGD 45mm instruction manual  | <a href="http://www.productselection.net/MANUALS/UK/mc_il_rsgd_45mm.pdf">http://www.productselection.net/MANUALS/UK/mc_il_rsgd_45mm.pdf</a>             |
| RSGD 75mm instruction manual  | <a href="http://www.productselection.net/MANUALS/UK/mc_il_rsgd_75mm.pdf">http://www.productselection.net/MANUALS/UK/mc_il_rsgd_75mm.pdf</a>             |
| RSGD Troubleshooting guide    | <a href="http://www.gavazziautomation.com/document/manual/mc_rsgd_qsg.pdf">http://www.gavazziautomation.com/document/manual/mc_rsgd_qsg.pdf</a>         |
| Modbus communication protocol | <a href="http://www.productselection.net/MANUALS/UK/mc_rsgd_modbus_manual.pdf">http://www.productselection.net/MANUALS/UK/mc_rsgd_modbus_manual.pdf</a> |
| RSGD 45mm Monitor software    | <a href="http://www.gavazziautomation.com/document/manual/mc_RS-USB.pdf">http://www.gavazziautomation.com/document/manual/mc_RS-USB.pdf</a>             |
| CAD drawings (RSGD 45mm)      | <a href="http://www.productselection.net/DXF/MC_RSGD_45mm.zip">http://www.productselection.net/DXF/MC_RSGD_45mm.zip</a>                                 |
| CAD drawings (RSGD 75mm)      | <a href="http://www.productselection.net/DXF/MC_RSGD_75mm.zip">http://www.productselection.net/DXF/MC_RSGD_75mm.zip</a>                                 |

**Selection guide and typical application settings**

| Category                  | Type                                 | Trip Class | Ramp-up setting [s] | Ramp-down setting [s] |
|---------------------------|--------------------------------------|------------|---------------------|-----------------------|
| <b>Compressors</b>        | Scroll compressor                    | 5          | 1                   | 0                     |
|                           | Screw compressor                     | 5          | 2 to 5              | 0                     |
|                           | Piston compressor                    | 5          | 2                   | 0                     |
|                           | Centrifugal compressor               | 10         | 10                  | 0                     |
| <b>Pumps</b>              | Hydraulic pump                       | 5          | 2                   | 0                     |
|                           | Centrifugal pump (start time <10sec) | 5          | 5 to 10             | 10                    |
|                           | Centrifugal pump (start time >10sec) | 10         | 10 to 20            | 15                    |
|                           | Piston pump                          | 10         | 5 to 10             | 0                     |
| <b>Fans</b>               | Centrifugal fan (<0.5m diameter)     | 10         | 5 to 10             | 0                     |
|                           | Centrifugal fan (>0.5m diameter)     | 20         | 15 to 30*           | 0                     |
|                           | Vacuum blowers                       | 10         | 5 to 10             | 0                     |
| <b>Feeders</b>            | Screw feeder                         | 10         | 2 to 10             | 0                     |
|                           | Auger                                | 10         | 5 to 10             | 0                     |
| <b>Rotating machinery</b> | Agitators                            | 10         | 5 to 15             | 0                     |
|                           | Mixers                               | 10         | 5 to 10             | 0                     |
|                           | Saws (<0.5m diameter)                | 10         | 5 to 10             | 5                     |
|                           | Saws (>0.5m diameter)                | 20         | 15 to 30*           | 10                    |
|                           | Grinder                              | 20         | 15 to 30*           | 0                     |
|                           | Crusher                              | 30         | 20 to 30*           | 0                     |
|                           | Conveyors                            | 10         | 5 to 10             | 5                     |

Note: when using the RSGD on high inertia loads (Trip Class 20, 30) ensure that enough time is left between starts to allow the RSGD to cool down.

\* For RSGD 45mm models set ramp-up time to 20.

| Motor FLC [A] | HP Rating @ 230V | Power kW @ 400V | Trip class 5                               | Trip class 10                              | Trip class 20                              | Trip class 30                              |
|---------------|------------------|-----------------|--|--|--|--|
| 6             | 1.5              | 3               | RSGD4012..<br>VD200<br>RSGD4012..<br>VD210 | RSGD4012..<br>VD200<br>RSGD4012..<br>VD210 | RSGD4025..<br>VD200<br>RSGD4012..<br>VD210 | RSGD4025..<br>VD200<br>RSGD4012..<br>VD210 |
| 9             | 2                | 3.7             | RSGD4012..<br>VD200<br>RSGD4012..<br>VD210 | RSGD4012..<br>VD200<br>RSGD4012..<br>VD210 | RSGD4025..<br>VD200<br>RSGD4016..<br>VD210 | RSGD4032..<br>VD200<br>RSGD4025..<br>VX210 |
| 12            | 3                | 5.5             | RSGD4012..<br>VD200<br>RSGD4012..<br>VD210 | RSGD4016..<br>VD200<br>RSGD4012..<br>VD210 | RSGD4045..<br>VX200<br>RSGD4025..<br>VX210 | RSGD4045..<br>VX200<br>RSGD4025..<br>VX210 |
| 16            | 5                | 7.5             | RSGD4016..<br>VD200<br>RSGD4016..<br>VD210 | RSGD4025..<br>VD200<br>RSGD4016..<br>VD210 | RSGD4045..<br>VX200<br>RSGD4032..<br>VX210 | RSGD4045..<br>VX200<br>RSGD4032..<br>VX210 |
| 22            | 7.5              | 11              | RSGD4025..<br>VD200<br>RSGD4025..<br>VX210 | RSGD4032..<br>VD200<br>RSGD4025..<br>VX210 | RSGD4045..<br>VX200<br>RSGD4045..<br>VX210 | RSGD4045..<br>VX200<br>RSGD4045..<br>VX210 |
| 30            | 10               | 15              | RSGD4032..<br>VD200<br>RSGD4032..<br>VX210 | RSGD4045..<br>VX200<br>RSGD4032..<br>VX210 | RSGD4055..<br>VX310C                       | RSGD4070..<br>VX310C                       |
| 37            | 10               | 18.5            | RSGD4045..<br>VX200<br>RSGD4045..<br>VX210 | RSGD4045..<br>VX200<br>RSGD4045..<br>VX210 | RSGD4070..<br>VX310C                       | RSGD4085..<br>VX310C                       |
| 45            | 15               | 22              | RSGD4045..<br>VX200<br>RSGD4045..<br>VX210 | RSGD4045..<br>VX200<br>RSGD4045..<br>VX210 | RSGD4085..<br>VX310C                       | RSGD40100..<br>VX311C                      |
| 55            | 20               | 30              | RSGD4055..<br>VX310C                       | RSGD4055..<br>VX310C                       | RSGD40100..<br>VX311C                      | -  |
| 70            | 25               | 37              | RSGD4070..<br>VX310C                       | RSGD4070..<br>VX310C                       | -  | -  |
| 85            | 30               | 45              | RSGD4085..<br>VX310C                       | RSGD4085..<br>VX310C                       | -  | -  |
| 100           | 30               | 55              | RSGD40100..<br>VX311C                      | RSGD40100..<br>VX311C                      | -  | -  |

- Contact Carlo Gavazzi representative for further information.
- Option "E0": 110 - 400 VAC or option "F0": 24 VAC/DC.

| Motor FLC [A] | HP rating @ 480V | HP Rating @ 600V | Trip class 5          | Trip class 10        | Trip class 20         | Trip class 30        |
|---------------|------------------|------------------|-----------------------|----------------------|-----------------------|----------------------|
| 6             | 3                | 5                | RSGD6012..<br>VD210   | RSGD6012..<br>VD210  | RSGD6012..<br>VX210   | RSGD6012..<br>VX210  |
| 9             | 5                | 7.5              | RSGD6012..<br>VD210   | RSGD6012..<br>VD210  | RSGD6016..<br>VX210   | RSGD6025..<br>VX210  |
| 11            | 7.5              | 10               | RSGD6012..<br>VD210   | RSGD6012..<br>VD210  | RSGD6025..<br>VX210   | RSGD6025..<br>VX210  |
| 16            | 10               | 15               | RSGD6016..<br>VD210   | RSGD6016..<br>VX210  | RSGD6032..<br>VX210   | RSGD6032..<br>VX210  |
| 22            | 15               | 20               | RSGD6025..<br>VX210   | RSGD6025..<br>VX210  | RSGD6055..<br>VX310C  | RSGD6055..<br>VX310C |
| 27            | 20               | 25               | RSGD6032..<br>VX210   | RSGD6032..<br>VX210  | RSGD6055..<br>VX310C  | RSGD6055..<br>VX310C |
| 32            | 20               | 30               | RSGD6032..<br>VX210   | RSGD6032..<br>VX210  | RSGD6070..<br>VX310C  | RSGD6070..<br>VX310C |
| 41            | 30               | 40               | RSGD6045..<br>VX200   | RSGD6045..<br>VX200  | RSGD6085..<br>VX310C  | RSGD6085..<br>VX310C |
| 52            | 40               | 50               | RSGD6055..<br>VX310C  | RSGD6055..<br>VX310C | RSGD60100..<br>VX311C | -                    |
| 70            | 50               | 60               | RSGD6070..<br>VX310C  | RSGD6070..<br>VX310C | -                     | -                    |
| 85            | 60               | 75               | RSGD6085..<br>VX310C  | RSGD6085..<br>VX310C | -                     | -                    |
| 100           | 75               | 100              | RSGD60100..<br>VX311C | RSGD6085..<br>VX310C | -                     | -                    |

- Contact Carlo Gavazzi representative for further information.
- Option "GG": 100 - 240 VAC or option "FF": 24 VAC/DC.

Note: Option FF available only for RSGD 75mm models

Caution: the actual motor amps may be higher or lower than the average values listed above. We suggest to use the actual motor current as listed on the motor nameplate. Use this table as a guide only.

### CARLO GAVAZZI compatible components

| Purpose  | Component name/code   | Notes  |
|--|---|--|
| Manual motor starters                          | GMS-32 <input type="checkbox"/> - <input type="checkbox"/><br>GMS-63 <input type="checkbox"/> - <input type="checkbox"/><br>GMS-100 <input type="checkbox"/> - <input type="checkbox"/> | <input type="checkbox"/> :<br>S: standard<br>H: high breaking capacity   |
| Finger guards                                  | RFCG X6   | 6 pcs per box  |
| Cooling fan                                    | RFAN-75-40 12 X1  | For RSGD..100 only<br>Rated voltage : 12 VDC<br>Power consumption: 0.6 W |
| PC interface cable (Isolated USB to TTL cable) | RS-USB  | For RSGD..12 to RSGD..45 only  |



# Structure

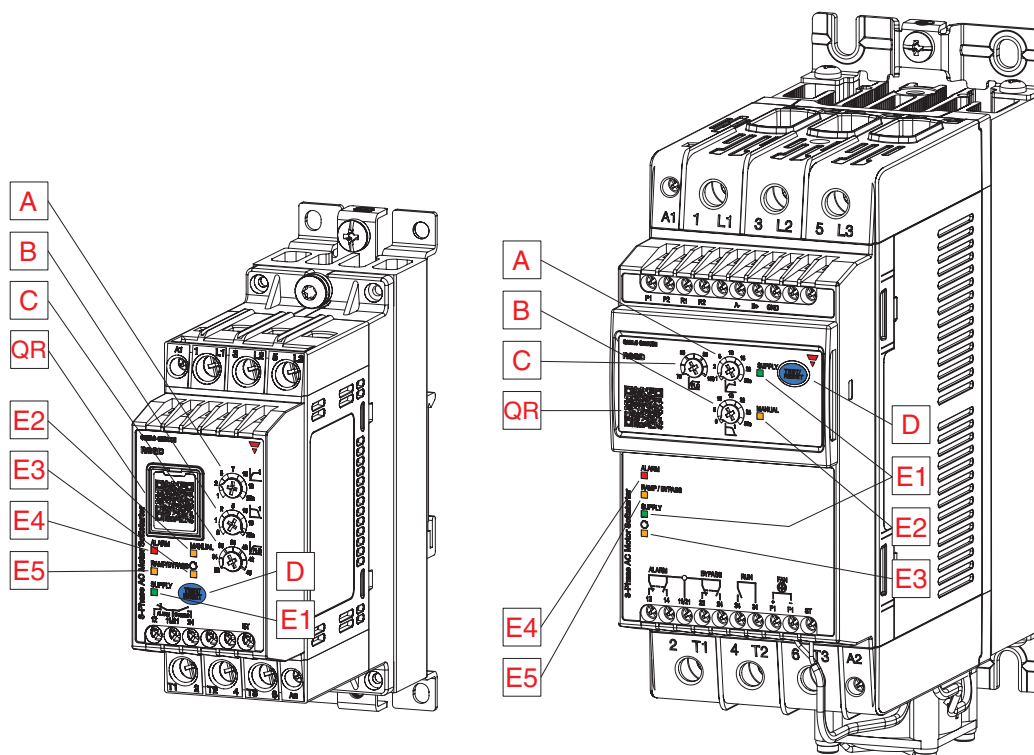

| Element | Component               | Function  |
|---------|-------------------------|---|
| A       | Ramp-up time selector   | Sets the desired motor starting time.   |
| B       | Ramp-down time selector | Sets the desired motor stopping time.   |
| C       | FLC knob selector       | Sets the motor full load current (FLC). The FLC is setting is used by the RSGD for the overload protection and for the maximum current allowed during motor start.  |
| D       | Test/Reset              | Simulate overload alarm (press for 1 sec when RSGD is in Idle state)<br>Set alarm recovery mode (press for 5 sec when RSGD is in Idle state)<br>Reset alarms (press for <1sec when RSGD is in alarm mode and alarm mode is Manual)<br>Enable/disable phase sequence protection (press for 10sec when RSGD is in Idle state) |
| E1      | LED indicators          | Supply. Indicates that the RSGD supply is ON.   |
| E2      | LED indicators          | Manual. Indicates the alarm reset mode.<br>Manual reset mode - LED ON, Auto reset mode - LED OFF<br>(Factory default setting: Auto, LED OFF)  |
| E3      | LED indicators          | Phase sequence. Indicates if the wrong phase sequence protection is enabled (LED OFF) or disabled (LED ON).<br>(Factory default setting: Enabled, LED OFF)  |
| E4      | LED indicators          | Alarm. Indicates that the RSGD is in alarm. The number of flashes indicates the alarm type.   |
| E5      | LED indicators          | Ramping/bypass. Indicates whether RSGD is in ramping (flashing) or bypass (fully ON).   |
| QR      | QR code                 | Scan to link to troubleshooting guide.  |

## Mode of operation

The RSGD series of soft starters works on two distinct self-learning algorithms depending on the ramp-up time settings.

| Ramp-up               | Mode of operation   |
|-----------------------|---|
| <b>1 or 2 seconds</b> | <ul style="list-style-type: none"> <li>• When the ramp-up knob is in position 1 or 2, the RSGD will follow a self learning current limit algorithm.</li> <li>• As soon as A1-A2 (or ST for RSGD60 models) control voltage signal is applied, the RSGD will start to ramp-up the motor.</li> <li>• At the very first start the current limit will be 4 x FLC setting.</li> <li>• In the subsequent starts, the RSGD will automatically adjust the current limit setting to maintain the motor start time as close as possible to the ramp-up time setting.</li> </ul>  |
| <b>≥ 5 seconds</b>    | <ul style="list-style-type: none"> <li>• When the ramp-up knob is in position 5 or above, the RSGD will follow a self-learning current ramp algorithm.</li> <li>• The RSGD will start with a set of default parameters for starting torque.</li> <li>• Depending on the ramp-up time setting, the RSGD will apply a current ramp algorithm to start the motor as close as possible to the set ramp-up time.</li> <li>• During the motor start, the current will be limited to a maximum of 3.5 x FLC setting.</li> <li>• In the subsequent starts, the RSGD will continue to adjust the starting parameters of initial torque and current ramp to ensure that the motor is started as close as possible to the set ramp-up time.</li> </ul> |

| Ramp-down              | Mode of operation  |
|------------------------|--|
| <b>1 to 30 seconds</b> | <ul style="list-style-type: none"> <li>• During ramp-down, the RSGD works on a torque control algorithm for smoother stopping of the motor.</li> <li>• As soon as the control voltage signal A1-A2 (or ST for RSGD 60 models) is removed, the RSGD will slow down the motor gradually according to the ramp-down setting.</li> <li>• The power semiconductors will be switched OFF as soon as the time (as per ramp-down setting) has elapsed unless there is a risk of exceeding the maximum temperature on the semiconductors. In such a case the RSGD will leave the motor to coast to stop.</li> </ul> |
| <b>0 seconds</b>       | <ul style="list-style-type: none"> <li>• If the ramp-down knob is set to 0, the RSGD will leave the motor to coast to stop (no ramp-down).</li> </ul>  |



# Features

**General**

|                      | RSGD 45mm      | RSGD 75mm    |
|----------------------|----------------|--------------|
| Material             | PA66           |              |
| Assembly             | DIN or panel   |              |
| Protection grade     | IP20           |              |
| Weight               | 0.5 to 0.75 Kg | About 2.3 Kg |
| Overvoltage category | Cat. III       |              |

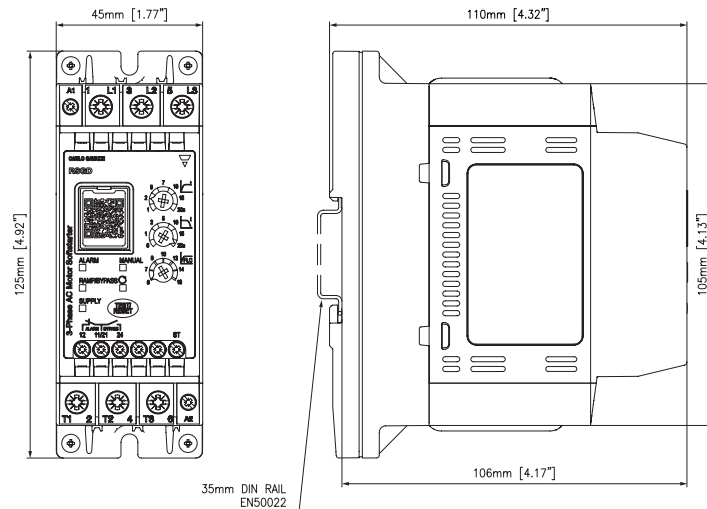

**Fig. 1** RSGD..12..VD200 to RSGD..32..VD200, RSGD..12..VD210 to RSGD..16..VD210

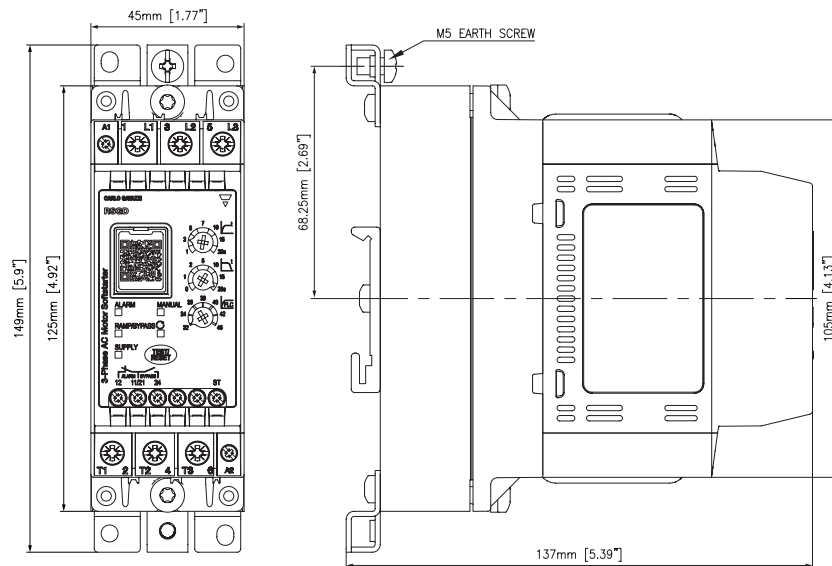

**Fig. 2** RSGD4045..VX200, RSGD..25VX210 to RSGD..45..VX210

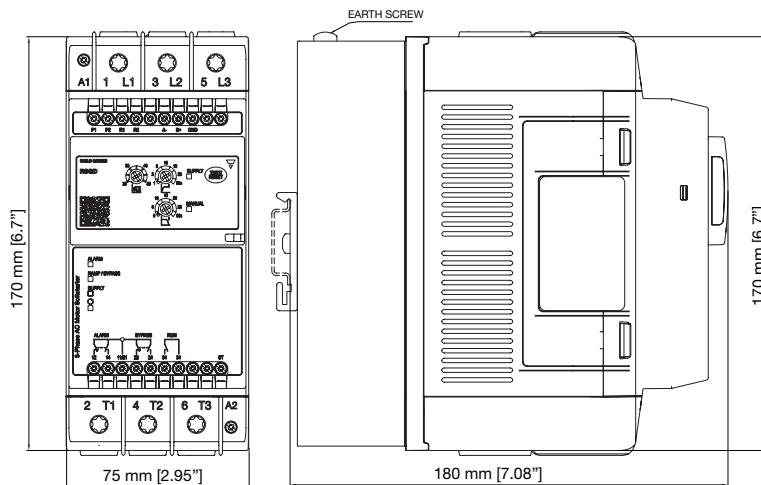

Fig. 3 RSGD..55..VX310C to RSGD..85..VX310C (DIN rail mount version)

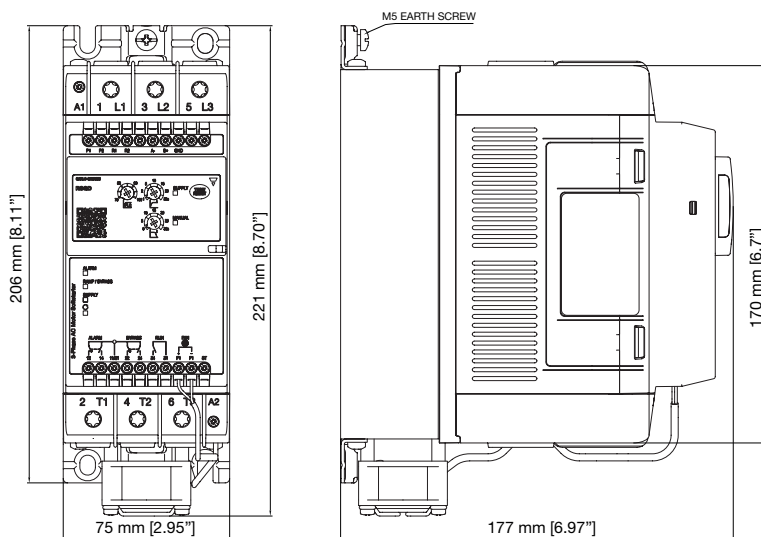

Fig. 4 RSGD..100..VX311C (panel mount version)

Settings

|                    | RSGD 45mm  | RSGD 75mm  |
|--------------------|--|--|
| Ramp-up time       | 1 - 20 s   | 1 - 30 s   |
| Ramp-down time     | 0 - 20 s   | 0 - 30 s   |
| Initial torque     | Automatically determined by RSGD   |  |
| FLC range settings | RSGD 12: 2 - 12 A<br>RSGD 16: 6 - 16 A<br>RSGD 25: 12 - 25 A<br>RSGD 32: 20 - 32 A<br>RSGD 45: 32 - 45 A | RSGD 55: 25 - 55 A<br>RSGD 70: 40 - 70 A<br>RSGD 85: 55 - 85 A<br>RSGD 100: 70 - 100 A |





## Power Supply

|  | RSGD40                         | RSGD60           |
|--|--------------------------------|------------------|
| Operational voltage range  | 187 - 440 VACrms               | 187 - 660 VACrms |
| Supply current at idle   | < 30 mArms                     |                  |
| Blocking voltage   | 1200 Vp                        | 1600 Vp          |
| Rated AC frequency   | 50/60 Hz (+/- 10%)             |                  |
| Rated insulation voltage   | 600 VAC                        | 690 VAC          |
| Dielectric withstand voltage:<br>Supply to input<br>Supply to heatsink | 2.5 kVrms<br>2.5 kVrms         |                  |
| Integrated varistor  | Yes (across controlled phases) |                  |

## Environmental

|                       |  |
|-----------------------|--|
| Working temperature   | -20°C to +60°C (-4°F to +140°F). Note: for temperatures > 40°C derating applies. |
| Storage temperature   | -40°C to +80°C (-40°F to +176°F).  |
| Relative humidity     | < 95% non-condensing @ 40°C.   |
| Pollution degree      | 2  |
| Installation category | III  |
| Installation altitude | 1000 m   |
| Vibration             | Acc. to IEC/EN 60068-2-6   |
| Frequency 1           | 2 [+3/-0] Hz to 25 Hz displacement +/- 1.6 mm                                    |
| Frequency 2           | 10 Hz to 55 Hz @ 2g (19.96m/s <sup>2</sup> ) @ constant displacement             |

## Compatibility and conformity

|                     |   |
|---------------------|---|
| Standard compliance | IEC/EN 60947-4-2  |
| Approvals           |     |

| <b>Electromagnetic compatibility (EMC) - immunity</b>   |  |
|---|--|
| <b>Electrostatic discharge (ESD)</b>                    | EN/IEC 61000-4-2<br>8 kV air discharge, 4 kV contact.  |
| <b>Radiated radio frequency</b>                         | EN/IEC 61000-4-3<br>10 V/m, from 80 MHz to 1 GHz (PC1)<br>10 V/m, from 1.4 to 2 GHz (PC1)<br>3 V/m, from 2 to 2.7 GHz (PC1)  |
| <b>Electrical fast transient (burst)</b>                | EN/IEC 61000-4-4<br>Output: 4 kV, 5 kHz (PC2)<br>AC input: 2 kV, 5 kHz (PC2)<br>DC input: 2 kV, 5 kHz (PC2)<br>Signal and control: 1 kV, 5 kHz (PC2)   |
| <b>Conducted radio frequency</b>                        | EN/IEC 61000-4-6<br>10 V/m, from 0.15 to 80 MHz  |
| <b>Electrical surge</b>                                 | EN/IEC 61000-4-5<br>Output, line to line: 1 kV (PC2)<br>Output, line to earth: 2 kV (PC2)<br>AC input, line to line: 1 kV (PC2)<br>AC input, line to earth: 2 kV (PC2)<br>DC input, line to line: 0.5 kV (PC2)<br>DC input, line to earth: 1 kV (PC2)<br>Signal and control, line to earth: 1 kV (PC2) |
| <b>Voltage dips</b>                                     | EN/IEC 61000-4-11<br>0% for 10 ms and 20 ms (PC2)<br>40% for 200 ms (PC2)<br>70% for 500 ms (PC2)<br>80% for 5000 ms (PC3)<br>0% for 5000 ms (PC3)   |
| <b>Electromagnetic compatibility (EMC) - emissions</b>  |  |
| <b>Radio interference field emission (radiated)</b>     | EN/IEC 55011<br>Class A (Industrial): from 30 to 1000 MHz  |
| <b>Radio interference voltage emissions (conducted)</b> | EN/IEC 55011<br>Class A (Industrial): from 0.15 to 30 MHz  |

Note: the tests were done using a screened cable for the communication lines.

PC2 (performance criteria 2): during the test, degradation of performance or partial loss of function is allowed. However, when the test is complete, the product should return operating as intended.

## Inputs

|  | RSGD40..E0V  | RSGD40..F0V                              | RSGD60..FFV                         | RSGD60..GGV                             |
|--|--|--|-------------------------------------|---|
| <b>Control voltage (Uc)</b>  | A1 - A2:<br>110 - 400 VAC<br>+10%, -15%              | A1 - A2:<br>24 VAC/VDC<br>+10%, -10%     | ST:<br>24 VAC/VDC<br>+10%, -15%     | ST:<br>100 - 240 VAC<br>+10%, -15%      |
| <b>Control voltage range (Uc)</b>  | 93.5 - 440 VAC                                       | 21.6 - 26.4<br>VAC/DC                    | 21.6 - 26.4<br>VAC/DC               | 85 - 264 VAC                            |
| <b>Maximum pick-up voltage</b>   | 80 VAC   | 20.4 VAC/DC                              | 20.4 VAC/DC                         | 80 VAC                                  |
| <b>Minimum drop out voltage</b>  | 20 VAC   | 5 VAC/DC                                 | 5 VAC/DC                            | 20 VAC                                  |
| <b>Supply voltage range (Us)</b>   | -  | -  | A1 - A2:<br>24 VAC/DC<br>+10%, -10% | A1 - A2:<br>100 - 240 VAC<br>+10%, -15% |
| <b>Rated AC frequency</b>  | 45 - 66 Hz   | 45 - 66 Hz<br>(applies to 24 VAC supply) |                                     | 45 - 66 Hz                              |
| <b>Rated insulation voltage (Ui)</b>   | 500 VAC  |  |                                     |   |
| <b>Dielectric strength:<br/>Dielectric withstand voltage<br/>Rated impulse withstand voltage</b> | 2 kVrms<br>4 kVrms                                   |  |                                     |   |
| <b>Control input current</b>   | 0.5 - 5 mArms<br>(0.55 - 1.3 mArms<br>for RSGD 45mm) | 0.4 - 1 mArms                            | 0.5 - 1.5 mArms                     | 0.4 - 3 mArms                           |
| <b>Input to output response time<br/>(Mains supply already present)</b>                          | 200 msec   | 200 msec                                 | 1.5 sec                             | 200 msec                                |
| <b>Input to output response time<br/>(Mains supply applied with<br/>control)</b>                 | 2.5 sec  |  | 2 sec                               |   |
| <b>Integrated varistor</b>   | Yes  |  |                                     |   |

Note 1: for the Canadian application, the control terminals A1, A2 (or A1, A2, ST for RSGD60 versions) of the RSGD devices shall be supplied by a secondary circuit where power is limited by a transformer, rectifier, voltage divider, or similar device that derives power from a primary circuit, and where the short-circuit limit between conductors of the secondary circuit or between conductors and ground is 1500VA or less. The short-circuit volt ampere limit is the product of the open circuit voltage and the short circuit ampere.

Note 2: RSGD60 soft starters require a separate 100 - 240V, 50/60Hz single phase control source. Output connections (L1, L2, L3, T1, T2, T3) are not galvanically isolated from the external supply connections (A1, A2, ST).

**Outputs**

|   | RSGD..12                          | RSGD..16 | RSGD..25                        | RSGD..32                        | RSGD..45 |
|---|-----------------------------------|----------|---------------------------------|---------------------------------|----------|
| <b>Overload cycle @ 40°C surrounding temperature (acc. to EN/IEC 60947-4-2)</b>                     | VD200: 3-5:175<br>VD210: 3-12:168 |          | VD200:3-5:355<br>VX210:3-12:168 | VD200:3-5:175<br>VX210:3-12:168 | 3-12:348 |
| <b>Maximum number of starts/hr @ rated overload cycle @ 40°C surrounding temperature</b>            | 20                                |          | VD200: 10<br>VX210: 20          | 20                              | 10       |
| <b>Maximum number of starts/hr (with fan) @ rated overload cycle @ 40°C surrounding temperature</b> | -                                 | -        | -                               | -                               | -        |
| <b>Rated operational current @ 40°C</b>   | 12 Arms                           | 16 Arms  | 25 Arms                         | 32 Arms                         | 45 Arms* |
| <b>Rated operational current @ 50°C</b>   | 12 Arms                           | 15 Arms  | 23 Arms                         | 28 Arms                         | 40 Arms  |
| <b>Rated operational current @ 60°C</b>   | 12 Arms                           | 13 Arms  | 21 Arms                         | 24 Arms                         | 34 Arms  |
| <b>Minimum load current</b>   | 1 Arms                            |          |                                 | 5 Arms                          |          |

|   | RSGD..55             | RSGD..70 | RSGD..85 | RSGD..100 |
|---|----------------------|----------|----------|-----------|
| <b>Overload cycle @ 40°C surrounding temperature (acc. to EN/IEC 60947-4-2)</b>                     | AC53b : 3 - 12 : 348 |          |          |           |
| <b>Maximum number of starts/hr @ rated overload cycle @ 40°C surrounding temperature</b>            | 10                   |          |          |           |
| <b>Maximum number of starts/hr (with fan) @ rated overload cycle @ 40°C surrounding temperature</b> | -                    | -        | -        | 10        |
| <b>Rated operational current @ 40°C</b>   | 55 Arms              | 70 Arms  | 85 Arms  | 100 Arms  |
| <b>Rated operational current @ 50°C</b>   | 50 Arms              | 64 Arms  | 78 Arms  | 88.5 Arms |
| <b>Rated operational current @ 60°C</b>   | 46 Arms              | 59 Arms  | 71 Arms  | 77 Arms   |
| <b>Minimum load current</b>   | 5 Arms               |          |          |           |

Note: the overload cycle describes the switching capability of the soft starter at a surrounding temperature of 40°C as described in EN/IEC 60947-4-2. An overload cycle AC53b:3-12:348 means that the soft starter can handle a starting current of 3x I<sub>e</sub> for 12 seconds followed by an OFF time of 348 seconds.

\* For RSGD6045 models, operational current is 45 Arms @ 25°C.

## Auxiliary relays

|                              | RSGD 45mm   | RSGD 75mm  |
|------------------------------|---|--|
| Number of output relays      | 2   | 3  |
| Function of relays           | Alarm, bypassed (top of ramp).                              | Alarm, bypassed (top of ramp), run.                                |
| Rated operational voltage    | 250 VAC/30 VDC  |  |
| Rated insulation voltage     | 250 VAC   |  |
| Dielectric withstand voltage | 2.5 kV  |  |
| Overvoltage category         | II  |  |
| Type of control circuit      | Electromechanical relay                                     |  |
| Number of contacts           | Alarm and bypassed: 1                                       | Alarm and bypassed: 2<br>Run: 1                                    |
| Type of contacts             | Alarm: normally closed (NC)<br>Bypassed: normally open (NO) | Alarm and bypassed: changeover (NO, NC)<br>Run: normally open (NO) |
| Type of current              | AC / DC   |  |
| Rated operational current    | 3 Arms @ 250 VAC, 3 Arms @ 30 VDC                           |  |

## RS485

|                                    |   |
|------------------------------------|---|
| <b>Type</b>                        | Bi-directional (static and dynamic variables and parameters)  |
| <b>Functions</b>                   | Configuration of device<br>Start/Stop<br>Modification of set-point parameters<br>Monitoring of measured variables                       |
| <b>Connection</b>                  | 2-wires<br>Note: to reduce the noise use a shielded cable and connect the shield to GND terminal and to the ground at the same point.   |
| <b>Address</b>                     | Default : 1<br>Selectable via software: range 1 - 247   |
| <b>Protocol</b>                    | MODBUS (RTU)  |
| <b>Factory defined data format</b> | Data bits: 8<br>Parity: none<br>Stop bit: 1<br>Selectable via software: parity: none (2 stop bits), odd (1 stop bit), even (1 stop bit) |
| <b>Baud rate</b>                   | Default: 9.6k bits/s<br>Selectable via software: 9.6k, 19.2k, 38.4k bits/s  |

Note: applies to RSGD 75mm models only

## Performance

### Current / power ratings: kW and HP @ 40°C

| Model     | IEC Rated Current | 220 - 240 VAC   | 380 - 415 VAC   | 440 - 480 VAC   | 550 - 600 VAC  |
|-----------|-------------------|-----------------|-----------------|-----------------|----------------|
| RSGD..12  | 12 Arms           | 3 kW / 3 HP     | 5.5 kW / 5 HP   | 5.5 kW / 7.5 HP | 9 kW / 10 HP   |
| RSGD..16  | 16 Arms           | 4 kW / 5 HP     | 7.5 kW / 7.5 HP | 9 kW / 10 HP    | 11 kW / 15 HP  |
| RSGD..25  | 25 Arms           | 5.5 kW / 7.5 HP | 11 kW / 10 HP   | 11 kW / 15 HP   | 20 kW / 20 HP  |
| RSGD..32  | 32 Arms           | 9 kW / 10 HP    | 15 kW / 15 HP   | 18.5 kW / 20 HP | 22 kW / 30 HP  |
| RSGD..45* | 45 Arms           | 11 kW / 15 HP   | 22 kW / 25 HP   | 22 kW / 30 HP   | 37 kW / 40 HP  |
| RSGD..55  | 55 Arms           | 15 kW / 20 HP   | 30 kW / 30 HP   | 30 kW / 40 HP   | 45 kW / 50 HP  |
| RSGD..70  | 70 Arms           | 20 kW / 25 HP   | 37 kW / 40 HP   | 45 kW / 50 HP   | 55 kW / 60 HP  |
| RSGD..85  | 85 Arms           | 22 kW / 30 HP   | 45 kW / 50 HP   | 45 kW / 60 HP   | 55 kW / 75 HP  |
| RSGD..100 | 100 Arms          | 30 kW / 30 HP   | 55 kW / 50 HP   | 55 kW / 75 HP   | 75 kW / 100 HP |

Ratings:

kW rating according to: IEC/EN 60947-4-2

HP rating according to: UL508

\* For RSGD6045 models, ratings are @25°C

### Starts per hour

The table below indicates the maximum number of starts/hr that can be done by the different RSGD models at different operating currents with a surrounding temperature of 40°C.

| Model           | Operational current |         |         |         |         |         |
|-----------------|---------------------|---------|---------|---------|---------|---------|
|                 | 6 Arms              | 12 Arms | 16 Arms | 25 Arms | 32 Arms | 45 Arms |
| RSGD..12..VD200 | 40                  | 20      | -       | -       | -       | -       |
| RSGD..16..VD200 | 50                  | 25      | 20      | -       | -       | -       |
| RSGD..25..VD200 | 45                  | 20      | 15      | 10      | -       | -       |
| RSGD..32..VD200 | 100                 | 55      | 40      | 25      | 20      | -       |
| RSGD..45..VX200 | 80                  | 40      | 30      | 18      | 15      | 10      |

| Model           | Operational current |         |         |         |         |         |
|-----------------|---------------------|---------|---------|---------|---------|---------|
|                 | 6 Arms              | 12 Arms | 16 Arms | 25 Arms | 32 Arms | 45 Arms |
| RSGD..12..VD210 | 40                  | 20      | -       | -       | -       | -       |
| RSGD..16..VD210 | 50                  | 25      | 20      | -       | -       | -       |
| RSGD..25..VX210 | 90                  | 40      | 30      | 20      | -       | -       |
| RSGD..32..VX210 | 100                 | 55      | 40      | 25      | 20      | -       |
| RSGD..45..VX210 | 80                  | 40      | 30      | 18      | 15      | 10      |

| Model             | Operational current |         |         |         |         |          |
|-------------------|---------------------|---------|---------|---------|---------|----------|
|                   | 25 Arms             | 45 Arms | 55 Arms | 70 Arms | 85 Arms | 100 Arms |
| RSGD..55..VX310C  | 25                  | 13      | 10      | -       | -       | -        |
| RSGD..70..VX310C  | 30                  | 16      | 13      | 10      | -       | -        |
| RSGD..85..VX310C  | 40                  | 21      | 17      | 12      | 10      | -        |
| RSGD..100..VX311C | 40                  | 22      | 18      | 14      | 12      | 10       |



▶ Current derating curves

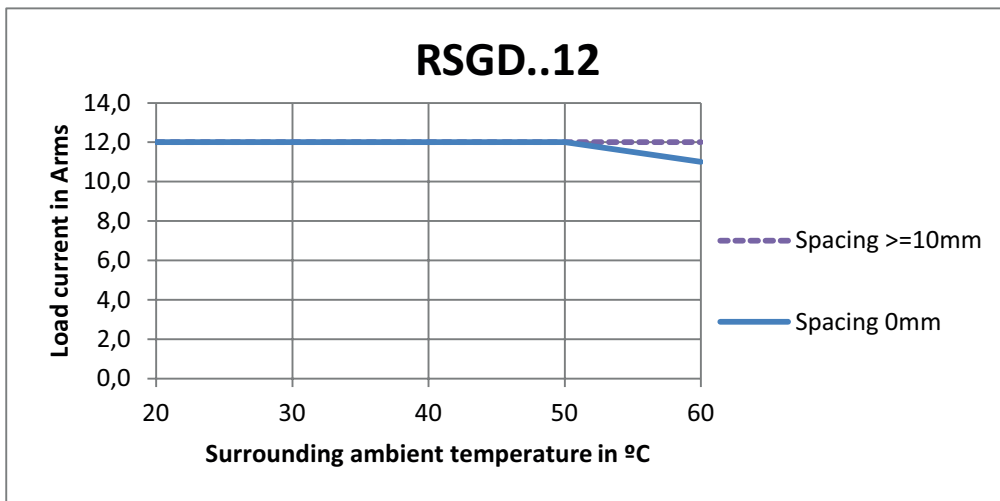
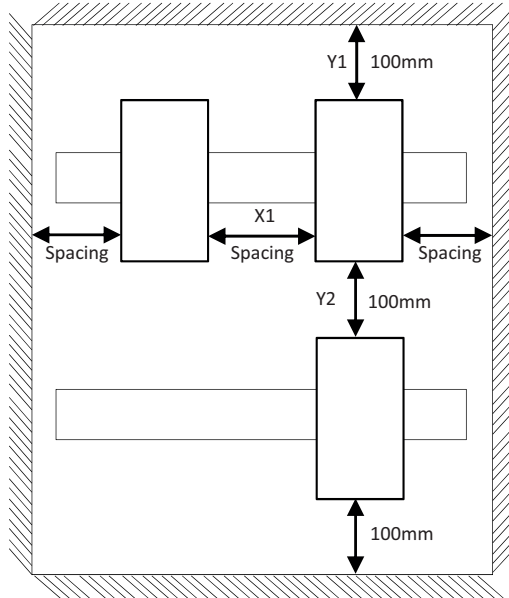

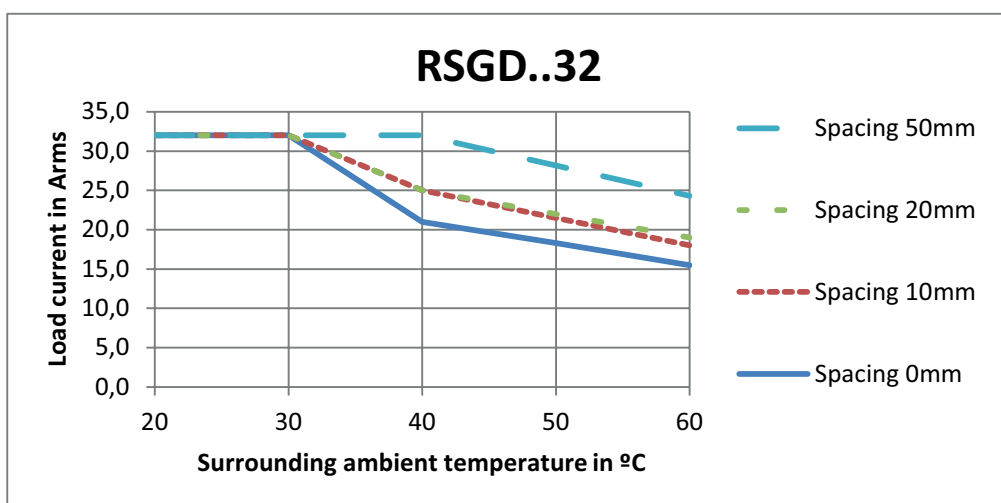
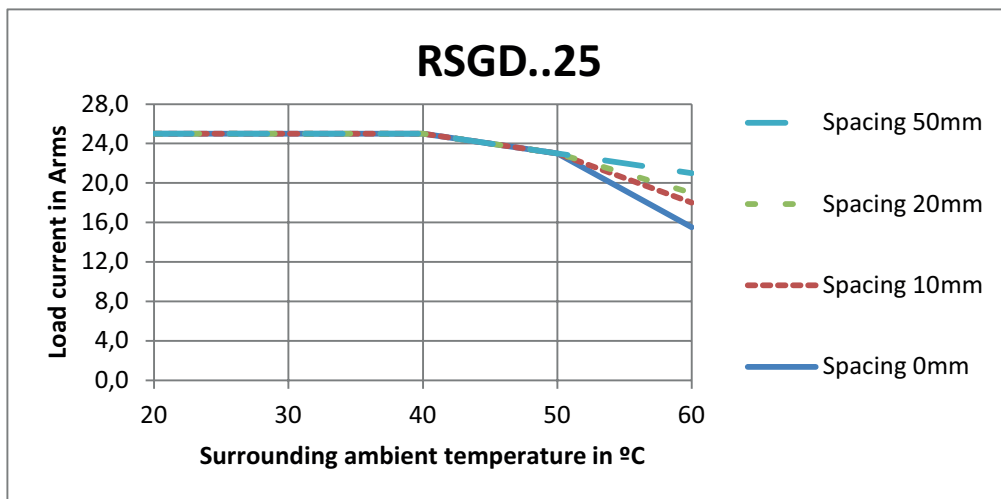
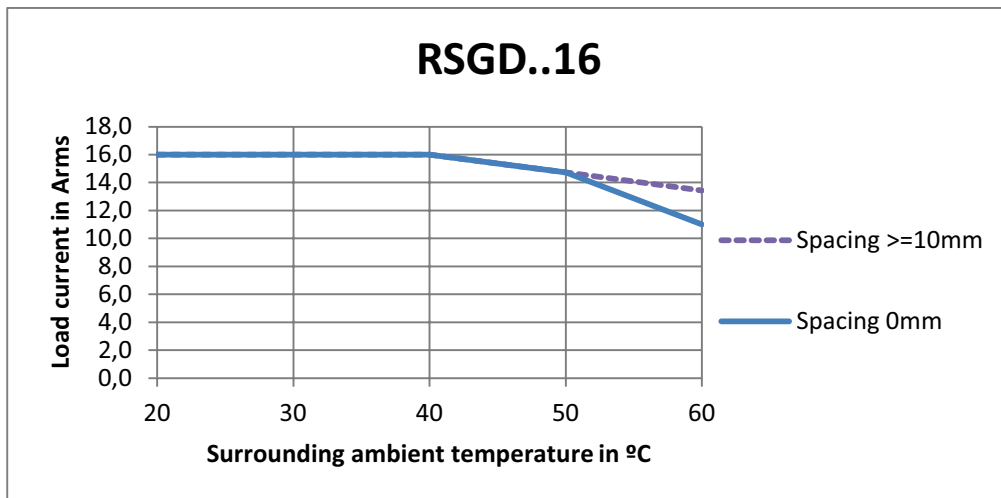

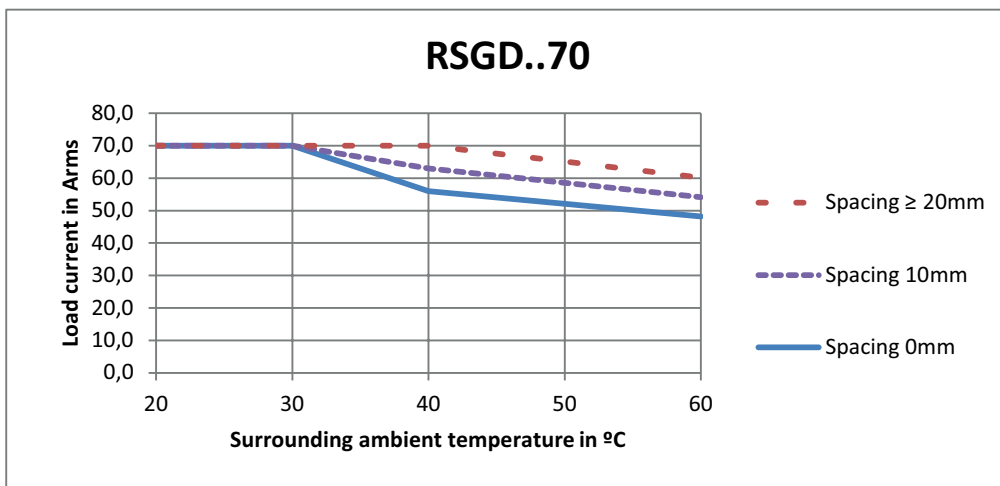
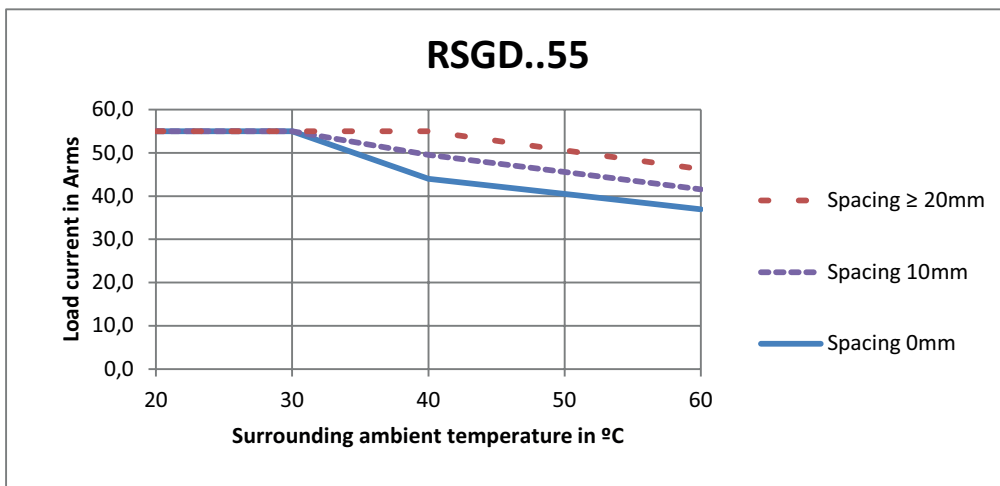
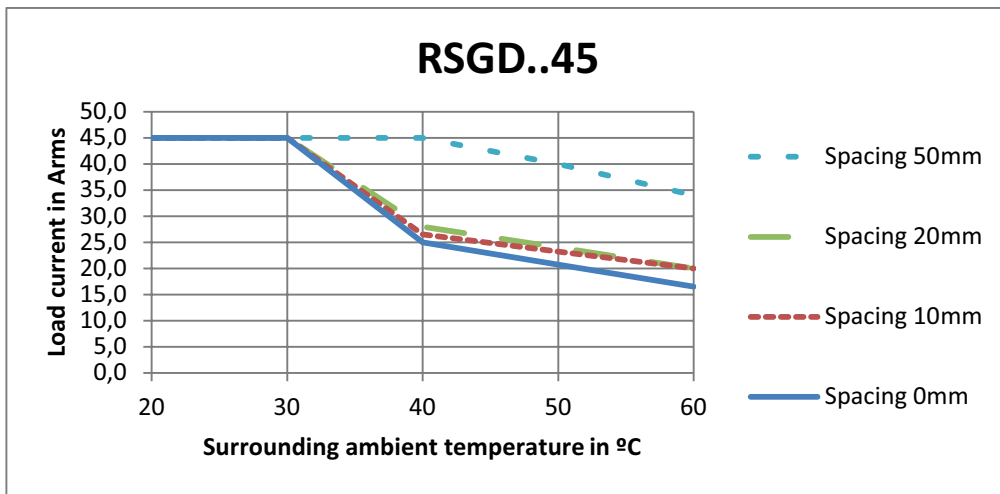

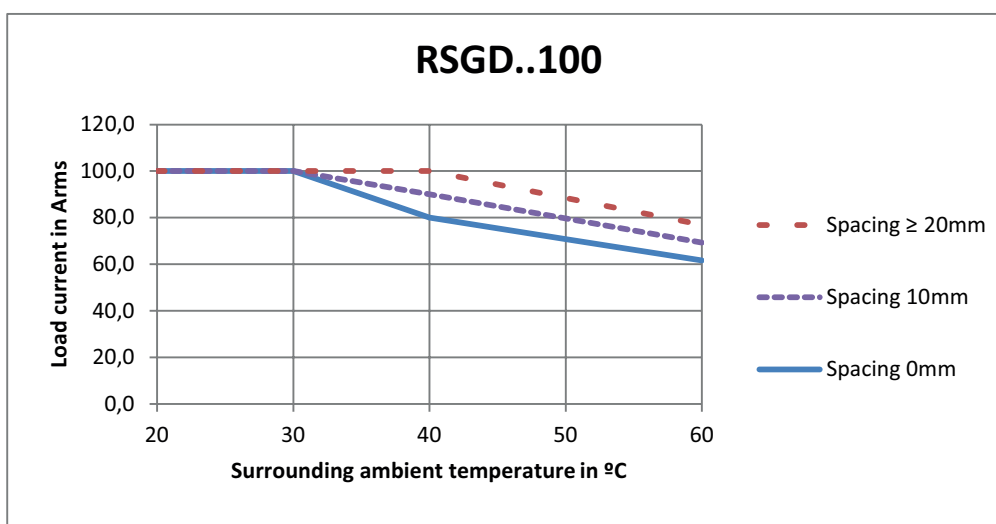
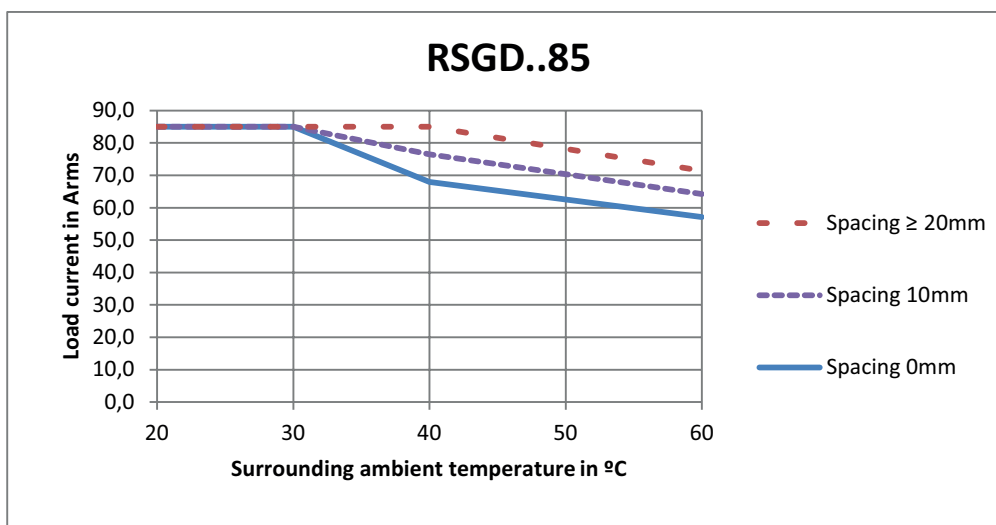

## Maximum Power Dissipation at $I_e$

|           | RSGD40            |               | RSGD60            |               |
|-----------|-------------------|---------------|-------------------|---------------|
|           | E0: 110 - 400 VAC | F0: 24 VAC/DC | GG: 100 - 240 VAC | FF: 24 VAC/DC |
| RSGD..12  | 20.3 W            |               | 6.4 W             | -             |
| RSGD..16  | 20.8 W            |               | 6.8 W             | -             |
| RSGD..25  | 21.5 W            |               | 7.0 W             | -             |
| RSGD..32  | 22.6 W            |               | 13.5 W            | -             |
| RSGD..45  | 23.9 W            |               | 16.5 W            | -             |
| RSGD..55  | 19.5 W            |               | 16.2 W            | 3.1 W         |
| RSGD..70  | 28.4 W            |               | 20.0 W            | 4.5 W         |
| RSGD..85  | 28.8 W            |               | 21.0 W            | 8.2 W         |
| RSGD..100 | 29.3 W            |               | 22.3 W            | 8.2 W         |

# Connection Diagrams

## Terminal markings

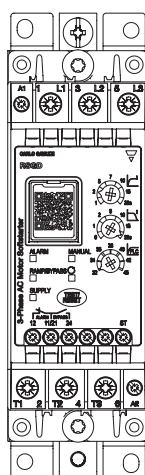

Fig. 5 RSGD 45mm

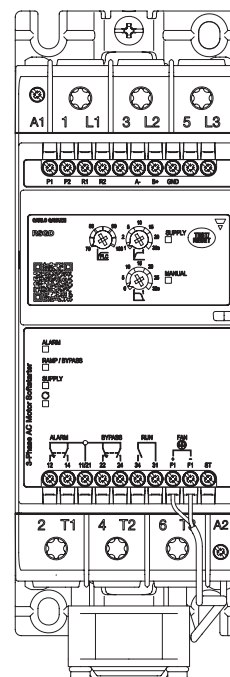
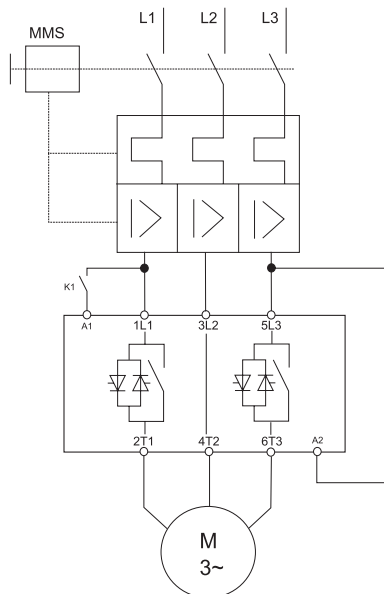

Fig. 6 RSGD 75mm

| Marking          | RSGD 45mm   |                 | RSGD 75mm                                    |                 |
|------------------|---|-----------------|--|-----------------|
|                  | RSGD40  | RSGD60          | RSGD40                                       | RSGD60          |
| 1 L1, 3 L2, 5 L3 | Line connections  |                 |  |                 |
| 2 T1, 4 T2, 6 T3 | Load connections  |                 |  |                 |
| A1, A2           | Control voltage   | Supply voltage  | Control voltage                              | Supply voltage  |
| ST               | -   | Control voltage | -  | Control voltage |
| 11, 12           | Alarm indication (normally closed, NC)  |                 |  |                 |
| 11, 14           | -   |                 | Alarm indication (normally open, NO)         |                 |
| 21, 22           | -   |                 | Top of ramp indication (normally closed, NC) |                 |
| 21, 24           | Top of ramp indication (normally open, NO)  |                 |  |                 |
| 31, 34           | -   |                 | Run relay (normally open, NO)                |                 |
| R1, R2           | -   |                 | Remote reset of alarms                       |                 |
| P1, P2           | -   |                 | PTC input                                    |                 |
| A -, B + , GND   | -   |                 | Modbus connections                           |                 |
| F1+, F1- *       | -   |                 | Fan connection                               |                 |
| <b>Note:</b>     | For the 24VDC (RSGD40..F0, RSGD60..FF) models, connect A1 to the positive (+) and A2 to the negative (-) terminal.<br>* Only for RSGD..100 models |                 |  |                 |

**Wiring diagrams**



**Fig. 7 RSGD40E0**

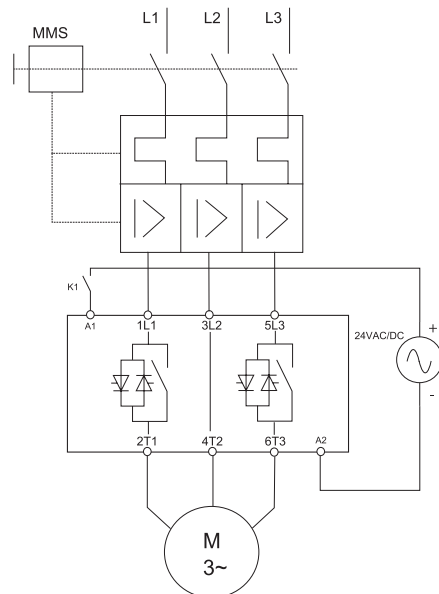

**Fig. 8 RSGD40F0**

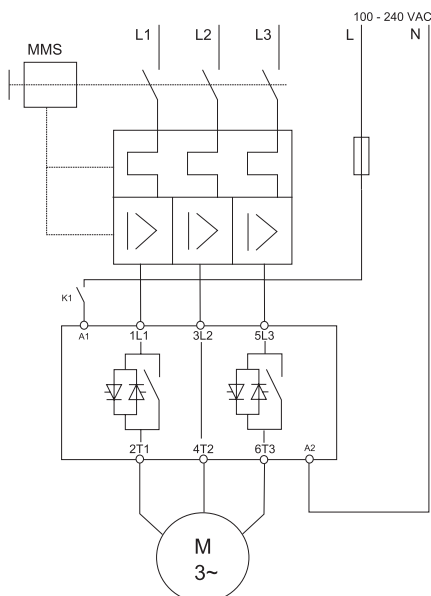

**Fig. 9 RSGD40E0**

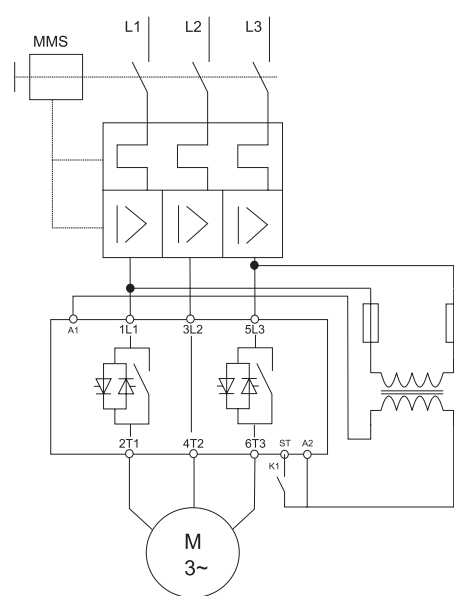

**Fig. 10 RSGD60. GG models: Apply 100 - 240VAC, FF models: Apply 24VAC/DC**

## Connection specifications

| Line conductors 1 L1, 3 L2, 5 L3, 2 T1, 4 T2, 6 T3 (acc. to EN60947-1) |   |                                      |
|--|---|--------------------------------------|
|  | RSGD 45mm   | RSGD 75mm                            |
| Flexible   | 2.5 - 10 mm <sup>2</sup><br>2.5 - 2 x 4 mm <sup>2</sup> | -                                    |
| Rigid (solid or stranded)  | 2.5 - 10 mm <sup>2</sup>                                | 2 x (10 - 50 mm <sup>2</sup> )       |
| Flexible with end sleeve (fer-rule)                                    | 2.5 - 10 mm <sup>2</sup>                                | 2 x (10 - 50 mm <sup>2</sup> )       |
| UL/cUL rated data  |   |                                      |
| Rigid (solid or stranded)  | 2 x (AWG 10 - 14)                                       | 2 x (AWG 8 - 1/0)                    |
| Terminal screws  | M4  | M8                                   |
| Maximum tightening torque  | 2.5 Nm (22 lb.in) with posidrive bit 2                  | 12 Nm (106 lb.in) with torx TT40 bit |
| Stripping length   | 8.0 mm  | 20.0 mm                              |

| Secondary conductors A1, A2 (acc. to EN60998) |   |           |
|---|---|-----------|
|   | RSGD 45mm                               | RSGD 75mm |
| Flexible                                      | 0.5 - 1.5 mm <sup>2</sup>               |           |
| Rigid (solid or stranded)                     | 0.5 - 2.5 mm <sup>2</sup>               |           |
| Flexible with end sleeve (fer-rule)           | 0.5 - 1.5 mm <sup>2</sup>               |           |
| UL/cUL rated data                             |   |           |
| Rigid (solid or stranded)                     | AWG 10 - 18                             |           |
| Terminal screws                               | M3                                      |           |
| Maximum tightening torque                     | 0.6 Nm (5.3 lb.in) with posidrive bit 0 |           |
| Stripping length                              | 6.0 mm                                  |           |

| Auxiliary conductors                |                                     |           |
|-------------------------------------|-------------------------------------|-----------|
|                                     | RSGD 45mm                           | RSGD 75mm |
| Rigid (solid or stranded)           | 0.5 - 2.5 mm <sup>2</sup>           |           |
| Flexible with end sleeve (fer-rule) | 0.05 - 1.5 mm <sup>2</sup>          |           |
| UL/cUL rated data                   |                                     |           |
| Rigid (solid or stranded)           | AWG 30 - 32                         |           |
| Terminal screws                     | M3                                  |           |
| Maximum tightening torque           | 0.45 Nm (4.0 lb.in) posidrive bit 0 |           |
| Stripping length                    | 6.0 mm                              |           |

Use 75°C copper (Cu) conductors.

## Troubleshooting

### LED status indications

| State                   | Supply<br>(green LED) | Ramp/Bypass<br>(yellow LED) | Alarm<br>(red LED) | Manual<br>(yellow LED) |
|-------------------------|-----------------------|-----------------------------|--------------------|------------------------|
| Idle                    | ON                    | OFF                         | OFF                | OFF/ON                 |
| Ramping                 | ON                    | Flashing                    | OFF                | OFF/ON                 |
| Bypass                  | ON                    | OFF                         | OFF                | OFF/ON                 |
| Alarm (Auto-recovery)   | ON                    | OFF                         | Flashing           | OFF                    |
| Alarm (Manual recovery) | ON                    | OFF                         | Flashing           | ON                     |
| Internal fault          | ON                    | OFF                         | OFF                | OFF/ON                 |

### Relay status indication

| State                      | Supply<br>(green LED) | Relay contact position |                    |                       |                        |                 |
|----------------------------|-----------------------|------------------------|--------------------|-----------------------|------------------------|-----------------|
|                            |                       | RSGD 45mm              |                    | RSGD 75mm             |                        |                 |
|                            |                       | Alarm<br>(11, 12)      | Bypass<br>(21, 24) | Alarm<br>(11, 12, 14) | Bypass<br>(21, 22, 24) | Run<br>(31, 34) |
| Idle                       | ON                    | Closed                 | Open               | 11, 12                | 21, 22                 | Open            |
| Ramping                    | ON                    | Closed                 | Open               | 11, 12                | 21, 22                 | Closed          |
| Bypass                     | ON                    | Closed                 | Closed             | 11, 12                | 21, 24                 | Closed          |
| Alarm<br>(Auto-recovery)   | ON                    | Open                   | Open               | 11, 14                | 21, 22                 | Open            |
| Alarm<br>(Manual recovery) | ON                    | Open                   | Open               | 11, 14                | 21, 22                 | Open            |
| Internal fault             | ON                    | Open                   | Open               | 11, 14                | 21, 22                 | Open            |

### Alarms

The RSGD includes a number of diagnostics and protection features each of which is signalled through a flashing sequence on the red LED.

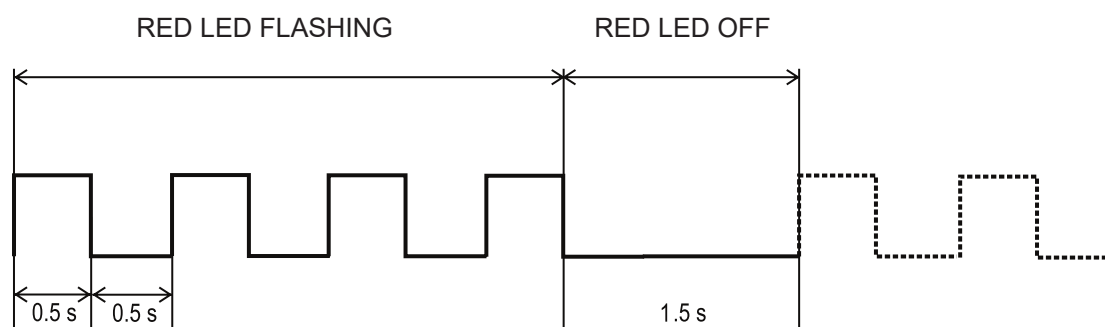





|  |  |
|--|--|
| <b>Number of flashes</b>                 | 2  |
| <b>Alarm</b>                             | Wrong phase sequence   |
| <b>Alarm description</b>                 | If the connection to the soft starter is not done in the correct sequence (L1, L2, L3), the RSGD will trigger the wrong phase sequence alarm and the motor will not be started.  |
| <b>Alarm recovery period</b>             | N/A  |
| <b>Consecutive alarms for hard reset</b> | 1  |
| <b>Action to recover alarm</b>           | User intervention is required to change the wiring sequence to recover alarm. Note: the phase sequence monitoring can be disabled. To disable the alarm, press the Test/Reset button for 10 seconds when the RSGD is in IDLE state. The yellow LED will turn ON.<br>ATTENTION: in this mode, if the wiring is not in the correct sequence, the motor will rotate in the reverse direction. |
| <b>Troubleshooting</b>                   | <ul style="list-style-type: none"> <li>• Check that wiring on L1, L2, L3 is in the correct sequence.</li> <li>• If you need to reverse the motor, make sure that the phase sequence LED is ON (phase sequence protection disabled).</li> </ul>   |

|  |   |
|--|---|
| <b>Number of flashes</b>                 | 3   |
| <b>Alarm</b>                             | Line voltage out of range   |
| <b>Alarm description</b>                 | At every power-up the RSGD automatically detects the supply voltage level and determines whether it is working on a 220, 400, 480* or 600* V supply. The under- or over- voltage alarm level is then set at a level of -20% and +20% (from the measured supply voltage level) respectively.<br>If the supply voltage level is out of these limits for more than 5 seconds then the line voltage out of range alarm will be triggered.<br>* Applies to RSGD60 models.<br>Note: for RSGD60 over-voltage alarm level (for the case of a 600V supply) is 675V (600V + 11%). |
| <b>Alarm recovery period</b>             | 5 minutes<br>(If manual reset mode is applied, alarm can be reset by pressing the Test/Reset button).   |
| <b>Consecutive alarms for hard reset</b> | 4   |
| <b>Action to recover alarm</b>           | The alarm will self-recover (in auto-recovery mode) after 5 minutes from when the supply voltage is within limits.  |
| <b>Troubleshooting</b>                   | <ul style="list-style-type: none"> <li>• Check supply voltage level across L1, L2, L3 terminals.</li> <li>• Make sure that you are not using a RSGD40 model on a supply voltage &gt; 440 VAC.</li> </ul>  |

|  |  |
|--|--|
| <b>Number of flashes</b>                 | 4  |
| <b>Alarm</b>                             | Phase loss (motor side)  |
| <b>Alarm description</b>                 | If any of the phases on the load (motor) side becomes open the RSGD will trip after 5 seconds to protect the motor from running/ starting on 2 phases.<br>Note: this alarm will also be triggered when a current unbalance of > 20% is detected on any of the three line currents for a minimum of 5 secs. Additionally if a SCR and/or bypass relay is open (damaged) the same alarm will be triggered. |
| <b>Alarm recovery period</b>             | 5 minutes<br>(If manual reset mode is applied, alarm can be reset by pressing the Test/Reset button).  |
| <b>Consecutive alarms for hard reset</b> | 4  |
| <b>Action to recover alarm</b>           | Check connections on the output side of the soft starter and on the motor terminals. The alarm will self-recover (in Auto-recovery mode) after 5 minutes.  |
| <b>Troubleshooting</b>                   | <ul style="list-style-type: none"> <li>• Check for any loose connections on the T1, T2, T3 side of the soft starter.</li> <li>• Check for any loose connections on the motor terminals.</li> <li>• Check motor windings.</li> </ul>  |

|  |  |
|--|--|
| <b>Number of flashes</b>                 | 5  |
| <b>Alarm</b>                             | Locked rotor   |
| <b>Alarm description</b>                 | If a current $\geq 8 \times \text{FLC}$ setting for 100 msec is detected, the RSGD will issue the locked rotor alarm.  |
| <b>Alarm recovery period</b>             | 5 minutes<br>(If manual reset mode is applied, alarm can be reset by pressing the Test/Reset button).  |
| <b>Consecutive alarms for hard reset</b> | 4  |
| <b>Action to recover alarm</b>           | The alarm will self-recover (in Auto-recovery mode) after 5 minutes.   |
| <b>Troubleshooting</b>                   | <ul style="list-style-type: none"> <li>• Check that FLC setting is not smaller than motor name plate current.</li> <li>• Check that the RSGD model is suitably rated for the motor.</li> <li>• Check motor windings resistance to check if motor is damaged.</li> </ul>  |
| <b>Number of flashes</b>                 | 7  |
| <b>Alarm</b>                             | Over-temperature   |
| <b>Alarm description</b>                 | The RSGD constantly measures the heatsink and thyristors (SCRs) temperature. If the maximum internal temperature is exceeded (for a minimum of 0.5 sec) an over-temperature alarm is triggered. This condition can be triggered by too many starts per hour, an over-load condition during starting and/or stopping or a high surrounding temperature.                                 |
| <b>Alarm recovery period</b>             | Depends on the cooling period.<br>(If MANUAL reset mode is applied, alarm can be reset by pressing the Test/Reset button).<br>The RSGD will only recover if the internal temperature is within safe limits.  |
| <b>Consecutive alarms for hard reset</b> | 4  |
| <b>Action to recover alarm</b>           | The alarm will self-recover (in Auto-recovery mode) - the recovery period will depend on the cooling time required by RSGD. The higher the surrounding temperature, the longer the cooling period.   |
| <b>Troubleshooting</b>                   | <ul style="list-style-type: none"> <li>• Check that the specified number of starts/hr are not exceeded.</li> <li>• Check that the surrounding temperature around the soft starter is within limits.</li> </ul>   |
| <b>Number of flashes</b>                 | 8  |
| <b>Alarm</b>                             | Overload   |
| <b>Alarm description</b>                 | The overload alarm can be triggered in case of the following conditions:<br>Measured current $> 1.05 \times \text{FLC}$ during transition from ramp-up to bypass.<br>High resistance ( $> 1000 \text{ ohm}$ ) at P1, P2 terminals.<br>Load current $> \text{FLC}$ . Trip time will vary according to Trip Class 10.  |
| <b>Alarm recovery period</b>             | Depends on the cooling period.<br>(If manual reset mode is applied, alarm can be reset by pressing the Test/Reset button).<br>The RSGD will only recover if the internal temperature is within safe limits.  |
| <b>Consecutive alarms for hard reset</b> | 4  |
| <b>Action to recover alarm</b>           | The alarm will recover automatically after 5 minutes. If manual reset mode is enabled, press Test/Reset button.<br>Note: allow enough time for the motor to cool before attempting the next start.   |
| <b>Troubleshooting</b>                   | <ul style="list-style-type: none"> <li>• Check that the P1, P2 terminals are shorted (unless PTC is used).</li> <li>• Make sure that the FLC setting is according to the current on the motor name plate.</li> <li>• Check for any blockages in the load.</li> <li>• If overload alarm occurs during ramp-up try to set a shorter ramp-up time or increase the FLC setting.</li> </ul> |

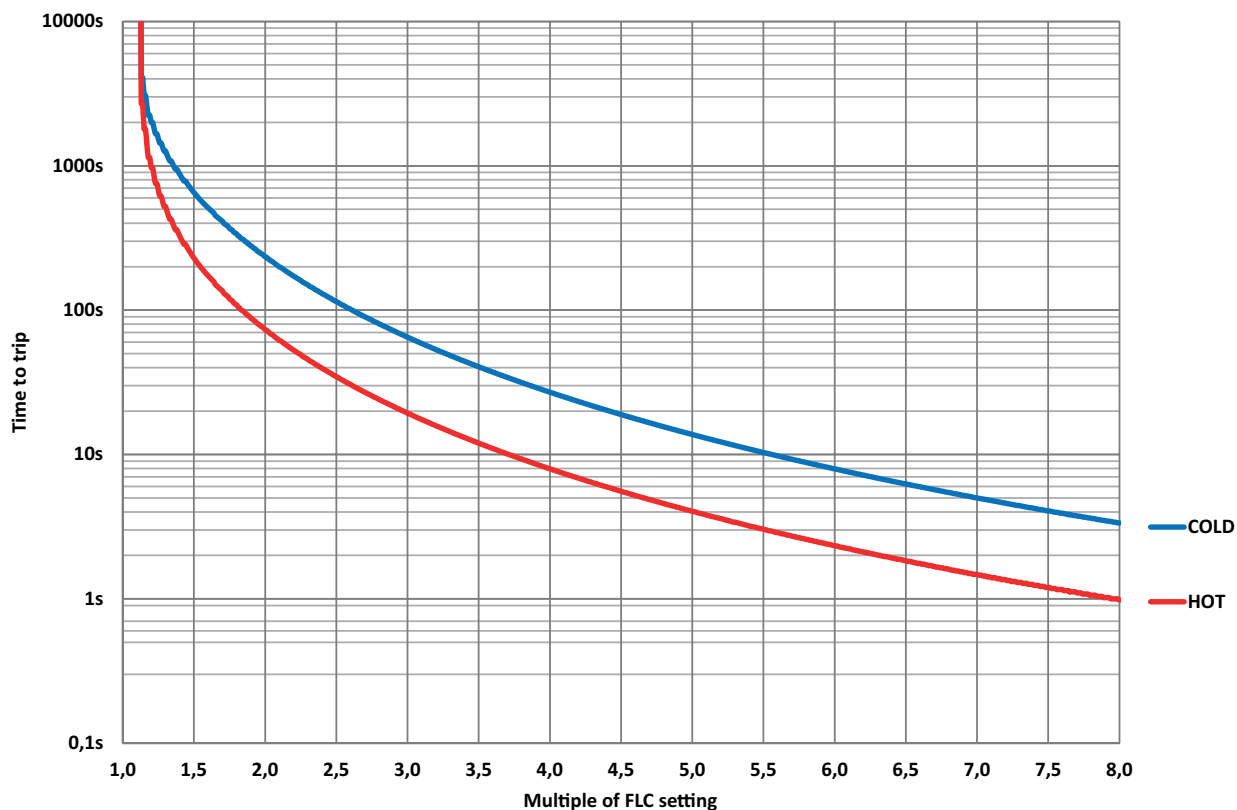

Fig. 11 RSGD Class 10 motor overload trip profile

| PTC resistance - P1, P2 connection |         |  |
|------------------------------------|---------|--|
| < 500Ω                             | No Trip | Normal running                                     |
| > 1000Ω                            | Trip    | Overload alarm (8 flashes) & alarm relay activated |
| < 300Ω                             | Reset   |  |

Note: Applies to RSGD 75mm models only.

|                                   |   |
|-----------------------------------|---|
| Number of flashes                 | 9   |
| Alarm                             | Supply voltage unbalance  |
| Alarm description                 | The RSGD measures the voltages on all the three phases and if there is a difference of more than 20% for ≥ 5sec between any of the phases, the RSGD will trigger the voltage unbalance alarm. |
| Alarm recovery period             | 5 minutes   |
| Consecutive alarms for hard reset | 4   |
| Action to recover alarm           | The alarm will recover automatically after 5 minutes. If manual reset mode is enabled, press Test/Reset button.   |
| Troubleshooting                   | <ul style="list-style-type: none"> <li>• Check supply voltage level across L1, L2, L3 terminals.</li> <li>• Check connections on the L1, L2, L3 terminals.</li> </ul>                         |

|  |   |
|--|---|
| <b>Number of flashes</b>                 | 10  |
| <b>Alarm</b>                             | Shorted thyristor (SCR)   |
| <b>Alarm description</b>                 | In case the RSGD detects that there is a damaged (shorted) thyristor (SCR) on any of the three phases, the soft starter will trip.  |
| <b>Alarm recovery period</b>             | -   |
| <b>Consecutive alarms for hard reset</b> | 1   |
| <b>Action to recover alarm</b>           | Note: this alarm is not resettable and it is suggested to replace the unit and contact a Carlo Gavazzi representative should this alarm occur.  |
| <b>Troubleshooting</b>                   | <ul style="list-style-type: none"> <li>• Check resistance across L1-T1 and L3-T3 to check for any short.</li> <li>• If any of the SCRs is damaged, replace the soft starter.</li> </ul> |

|  |   |
|--|---|
| <b>Number of flashes</b>                 | Fully ON  |
| <b>Alarm</b>                             | Internal fault  |
| <b>Alarm description</b>                 | In case there is an internal fault in the RSGD circuitry, the Red LED will remain continuously ON.  |
| <b>Alarm recovery period</b>             | -   |
| <b>Consecutive alarms for hard reset</b> | 1   |
| <b>Action to recover alarm</b>           | Note: this alarm is not resettable and it is suggested to replace the unit and contact a Carlo Gavazzi representative should this alarm occur.  |
| <b>Troubleshooting</b>                   | <ul style="list-style-type: none"> <li>• Check resistance across L1 - T1 and L3 - T3 to check for any short.</li> <li>• If any of the SCRs is damaged, replace the soft starter.</li> </ul> |

|   |  |
|---|--|
| <b>Remote reset of alarms (R1, R2)*</b> | <p>To reset alarms via the R1-R2 terminals you need to:</p> <p>Make sure that the alarm reset mode is set to MANUAL (MANUAL LED ON). To set the alarm reset mode to MANUAL press the Test/Reset button for 5 seconds when the RSGD is in IDLE mode.</p> <p>When RSGD is in alarm mode, short the terminals R1, R2 for 1 second. This will clear the alarm and RSGD will go to IDLE state.</p> <p>Note: do not apply voltage on R1, R2 terminals as this might damage the soft starter.</p> |
|---|--|

\* Applies to RSGD 75mm models only