

300/500mA Low Dropout Linear Voltage Regulator

General Description

The RT9161/A is a 300/500mA fixed output voltage low dropout linear regulator. Typical ground current is approximately 110µA, from zero to maximum loading conditions. Wide range of available output voltage fits most of applications. Built-in output current-limiting most thermal-limiting provide maximal protection against any fault conditions.

For ease of application, the RT9161/A comes in the popular 3-pin SOT-23 (300mA), SOT-89 (300mA), SOT-223 (500mA), or TO-92 packages.

Ordering Information

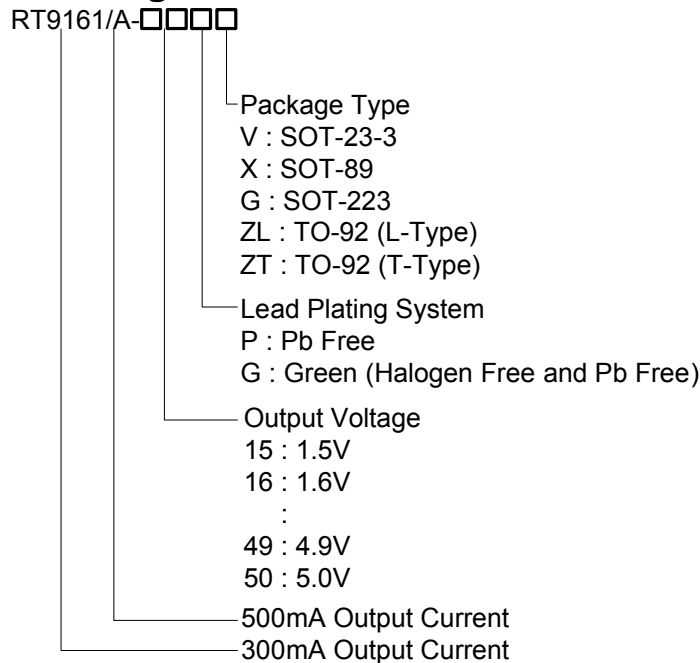

Note :

Richtek products are :

- ▶ RoHS compliant and compatible with the current require-ments of IPC/JEDEC J-STD-020.
- ▶ Suitable for use in SnPb or Pb-free soldering processes.

Features

- Low Dropout Voltage of 200mV at Output Current 100mA, 450mV at Output Current 300mA, and 750mV at 500mA Output Current
- Guaranteed 300/500mA Output Current
- Internal 1.5Ω P-MOSFET Draws No Base Current
- Low Ground Current 110µA
- 2% Accuracy Output Voltage
- Input Voltage Range up to 12V
- Extremely Tight Load Regulation
- Fast Transient Response
- Current-limiting and Thermal-limiting
- RoHS Compliant and 100% Lead (Pb)-Free

Applications

- Voltage Regulator for LAN Card, CD-ROM, and DVD
- Wireless Communication Systems
- Battery Powered Systems

Marking Information

For marking information, contact our sales representative directly or through a Richtek distributor located in your area.

Pin Configurations

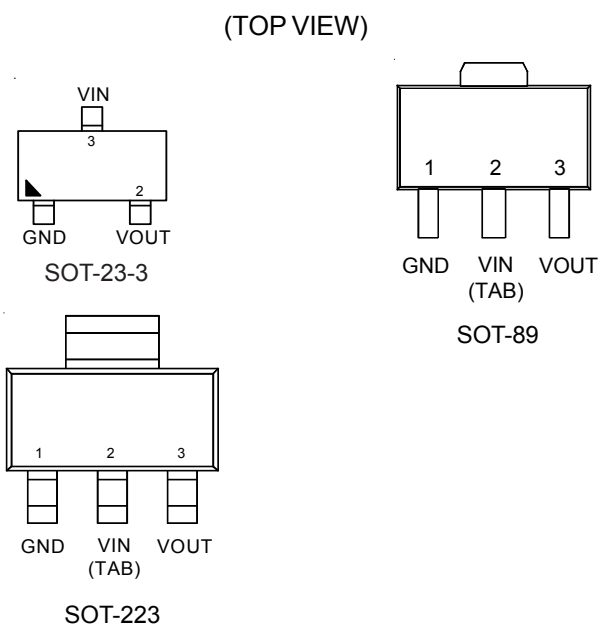

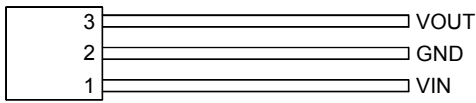

TO-92 (L-Type)

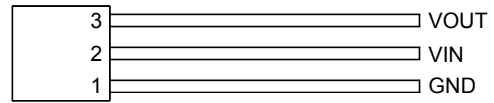

TO-92 (T-Type)

Typical Application Circuit

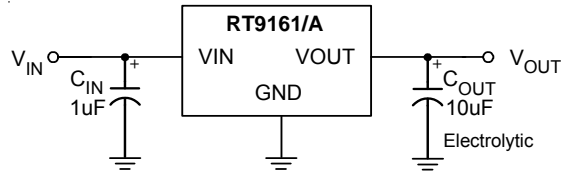

Part Status

Part No	Status	Package	Lead Plating System
RT9161A-XXPX	Lifebuy	SOT-89	P : Pb Free

The part status values are defined as below :

Active : Device is in production and is recommended for new designs.

Lifebuy : The device will be discontinued, and a lifetime-buy period is in effect.

NRND : Not recommended for new designs.

Preview : Device has been announced but is not in production.

EOL: Richtek has discontinued the production of the device.

Functional Pin Description

Pin Name	Pin Function
VOUT	Output Voltage.
GND	Ground.
VIN	Power Input.

Functional Block Diagram

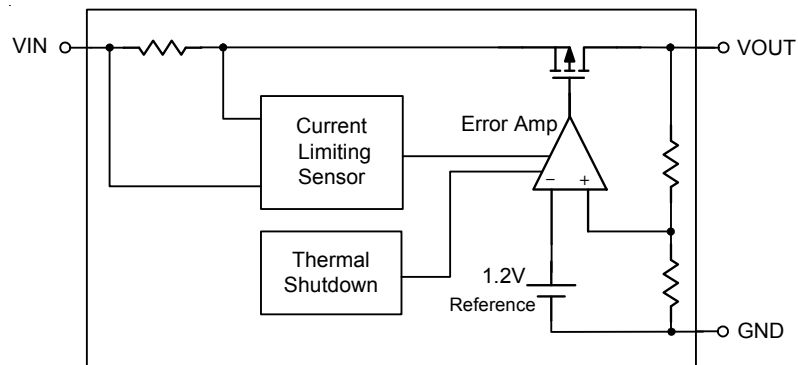

Absolute Maximum Ratings

- Input Voltage ----- -0.3 to 14V
- Operating Junction Temperature Range ----- -40°C to 125°C
- Storage Temperature Range ----- -65°C to 150°C
- Power Dissipation, P_D @ $T_A = 25^\circ\text{C}$
 - SOT-23-3 ----- 0.4W
 - SOT-89 ----- 0.571W
 - SOT-223 ----- 0.741W
 - TO-92 ----- 0.625W
- Package Thermal Resistance (Note 1)
 - SOT-23-3, θ_{JA} ----- 250°C/W
 - SOT-23-3, θ_{JC} ----- 140°C/W
 - SOT-89, θ_{JA} ----- 175°C/W
 - SOT-89, θ_{JC} ----- 100°C/W
 - SOT-223, θ_{JA} ----- 135°C/W
 - SOT-223, θ_{JC} ----- 15°C/W
 - TO-92, θ_{JA} ----- 160°C/W
 - TO-92, θ_{JC} ----- 125°C/W

Electrical Characteristics

($T_A = 25^\circ\text{C}$, $C_{IN} = 1\mu\text{F}$, $C_{OUT} = 10\mu\text{F}$, unless otherwise specified.)

Parameter	Symbol	Test Conditions	Min	Typ	Max	Unit	
Output Voltage Accuracy	ΔV_{OUT}	$I_L = 1\text{mA}$, $V_{IN} = 5\text{V}$	-2	--	2	%	
Output Voltage Temperature Coefficient			--	50	150	PPM/°C	
Line Regulation	ΔV_{LINE}	$I_L = 1\text{mA}$, $V_{IN} = 4.5$ to 12V	--	2	3	% V_{OUT}	
Load Regulation (Note 2)	ΔV_{LOAD}	$I_L = 1\text{mA}$ to $300/500\text{mA}$, $V_{IN} = 5\text{V}$	--	1	30/50	mV	
Current Limit (Note 3)	RT9161	I_{LIM}	$V_{IN} = 5\text{V}$, $V_{OUT} = 0\text{V}$	350	580	--	mA
	RT9161A			500	900	--	
Dropout Voltage (Note 4)	V_{DROP}	$I_L = 300/500\text{mA}$	--	450/750	600/1000	mV	
Standby Current	$I_{STANDBY}$	$I_L = 0$, $V_{IN} = 12\text{V}$	--	110	180	μA	

Note 1. θ_{JA} is measured in the natural convection at $T_A = 25^\circ\text{C}$ on a low effective single layer thermal conductivity test board of JEDEC 51-3 thermal measurement standard.

Note 2. Regulation is measured at constant junction temperature, using pulsed ON time.

Note 3. Current Limit is measured at constant junction temperature, using pulsed ON time.

Note 4. The dropout voltage is defined as $V_{IN} - V_{OUT}$, which is measured when V_{OUT} is $V_{OUT(NORMAL)} - 100\text{mV}$.

Typical Operating Characteristics

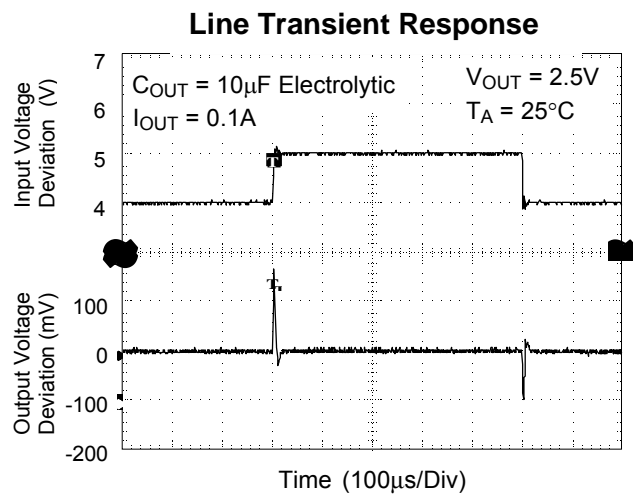
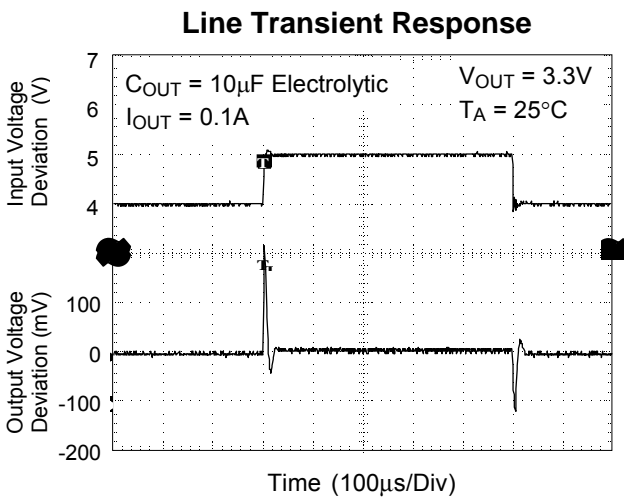
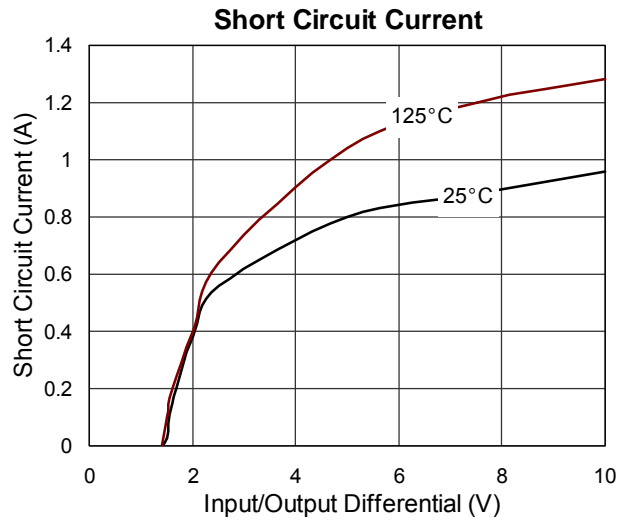
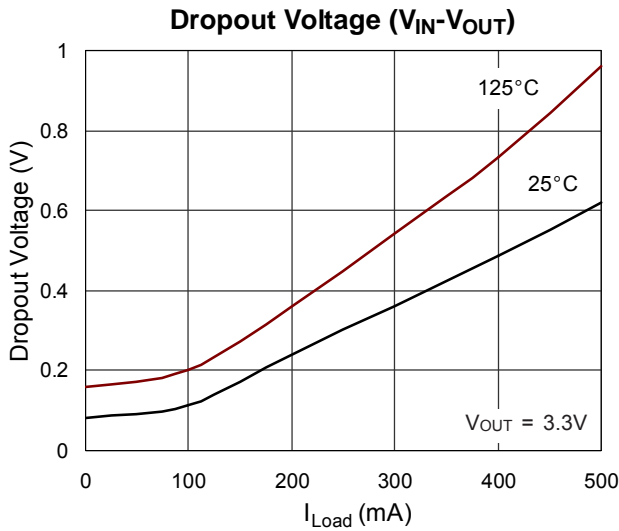
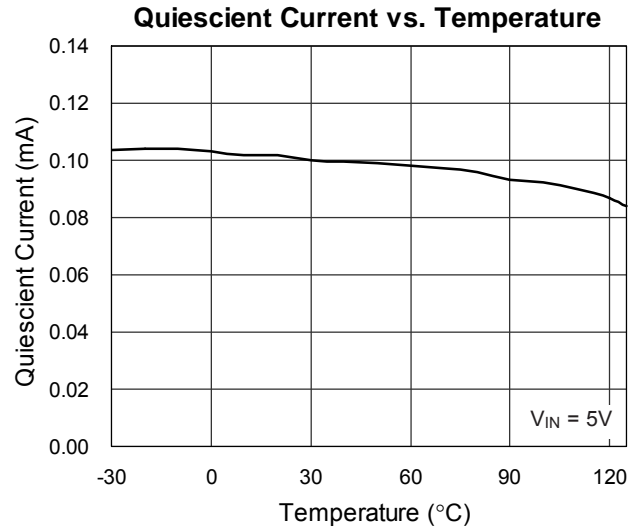
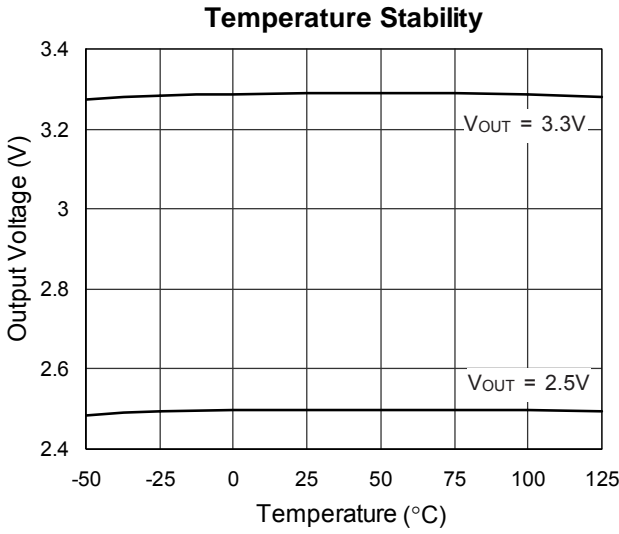

Load Transient Response

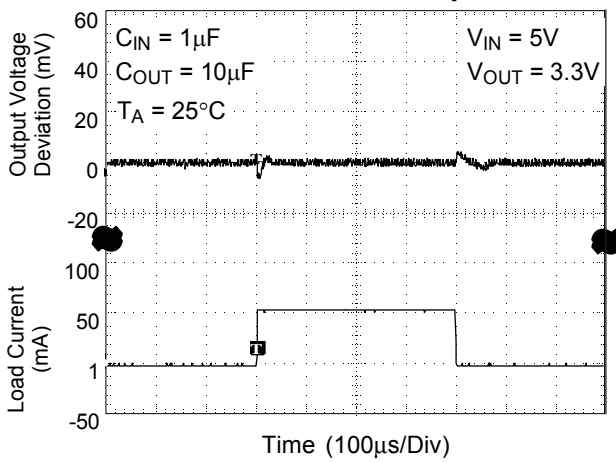

Load Transient Response

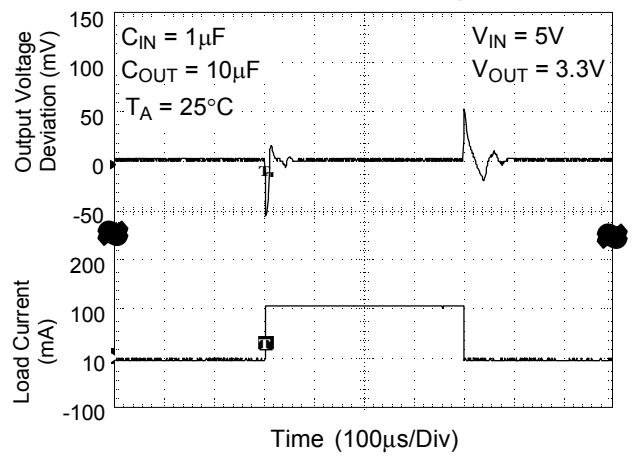

Load Transient Response

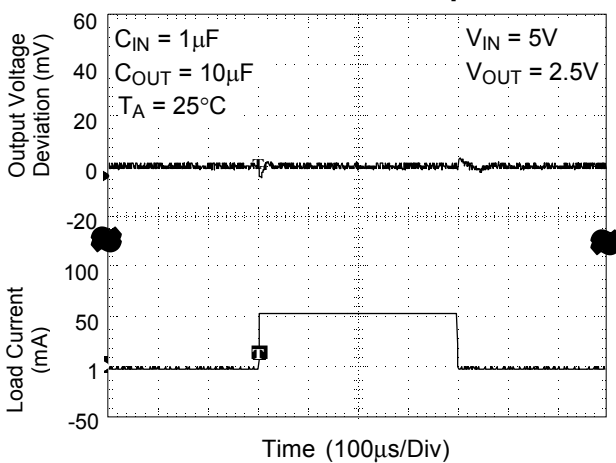

Load Transient Response

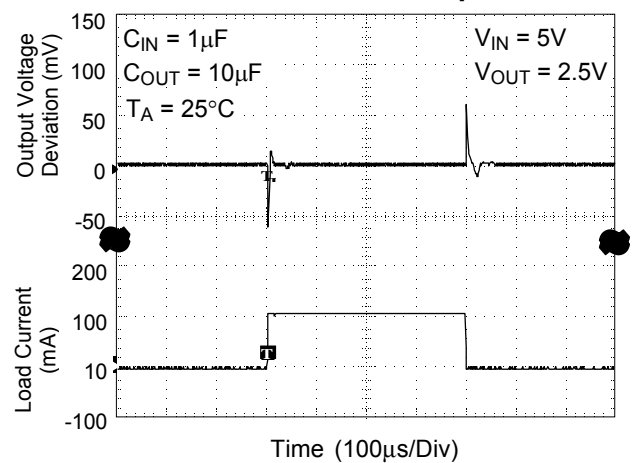

PSRR

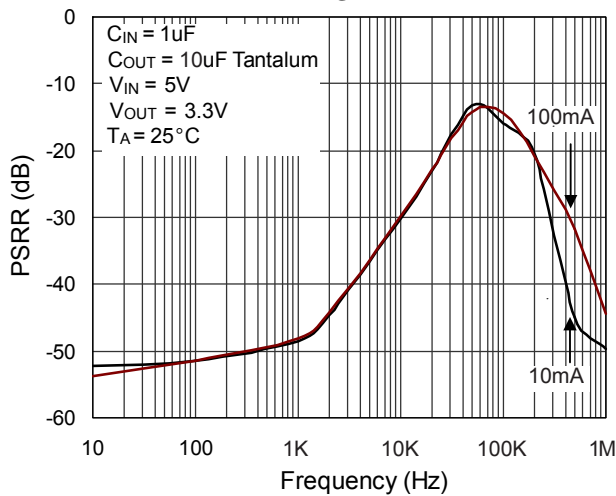

PSRR

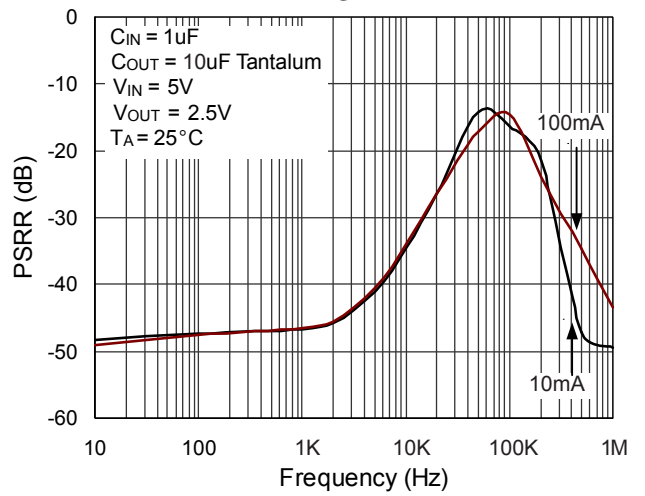

Application Information

A 10uF capacitor with 200mΩ or higher ESR, connecting between VOUT and GND pins, is recommended for stability. A capacitor with ESR smaller than 200 mΩ may cause VOUT oscillation as shown in Figure 1. Operating temperature should be well considered to ensure that the capacitance is no less than 10uF over the operating temperature range. Please take the notice that Aluminum electrolytic capacitors may cause VOUT oscillation when operating below -25°C. The capacitance can be increased without limit for better transient response.

A 1uF or higher capacitor should be placed between VIN and GND to filter out input noise and ensure stable output voltage.

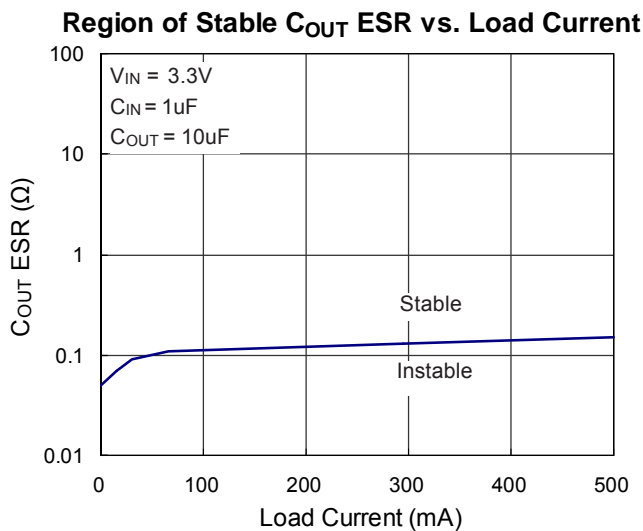

Figure 1

Thermal protection limits power dissipation in RT9161/A. When the operation junction temperature exceeds 165°C, the OTP circuit starts the thermal shutdown function and turns the pass element off. The pass element turn on again after the junction temperature cools by 30°C.

For continuous operation, do not exceed absolute maximum operation junction temperature 125°C. The power dissipation definition in device is :

$$P_D = (V_{IN} - V_{OUT}) \times I_{OUT} + V_{IN} \times I_Q$$

The maximum power dissipation depends on the thermal resistance of IC package, PCB layout, the rate of surroundings airflow and temperature difference between junction to ambient. The maximum power dissipation can be calculated by following formula :

$$P_{D(MAX)} = (T_{J(MAX)} - T_A) / \theta_{JA}$$

Where $T_{J(MAX)}$ is the maximum operation junction temperature 125°C, T_A is the ambient temperature and the θ_{JA} is the junction to ambient thermal resistance.

For recommended operating conditions specification of RT9161/A, where $T_{J(MAX)}$ is the maximum junction temperature of the die (125°C) and T_A is the maximum ambient temperature. The junction to ambient thermal resistance θ_{JA} is layout dependent. For SOT-223 packages, the thermal resistance θ_{JA} is 135°C/W on the standard JEDEC 51-3 single-layer 1S thermal test board. The maximum power dissipation at $T_A = 25^\circ\text{C}$ can be calculated by following formula :

$$P_{D(MAX)} = (125^\circ\text{C} - 25^\circ\text{C}) / 250 = 0.400 \text{ W for}$$

SOT-23-3 packages

$$P_{D(MAX)} = (125^\circ\text{C} - 25^\circ\text{C}) / 175 = 0.571 \text{ W for}$$

SOT-89 packages

$$P_{D(MAX)} = (125^\circ\text{C} - 25^\circ\text{C}) / 135 = 0.741 \text{ W for}$$

SOT-223 packages

$$P_{D(MAX)} = (125^\circ\text{C} - 25^\circ\text{C}) / 160 = 0.625 \text{ W for}$$

TO-92 packages

The maximum power dissipation depends on operating ambient temperature for fixed $T_{J(MAX)}$ and thermal resistance θ_{JA} . For RT9161/A packages, the Figure 2 of derating curves allows the designer to see the effect of rising ambient temperature on the maximum power allowed.

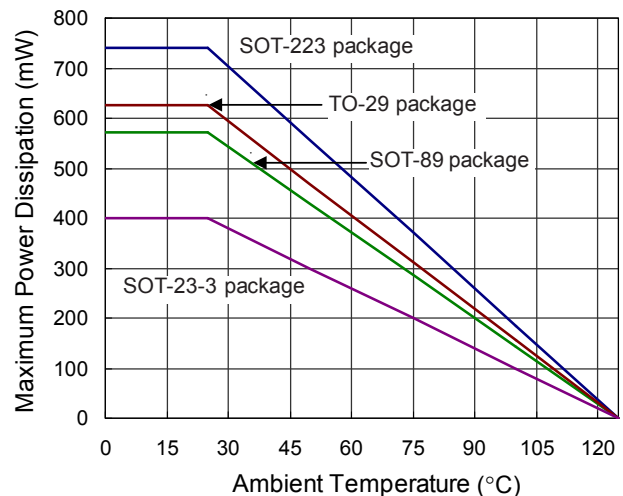
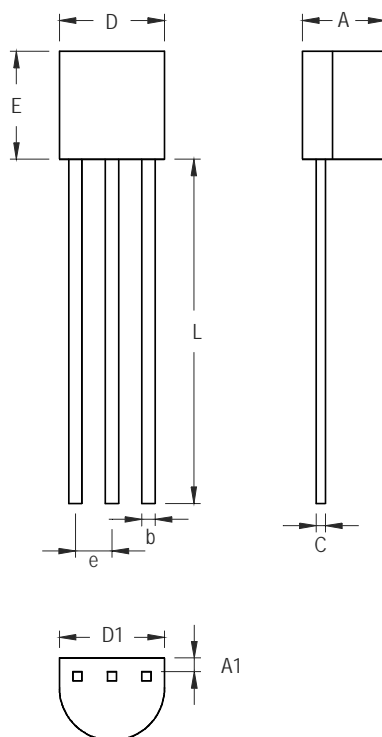

Figure 2. Derating Curves

Outline Dimension



Symbol	Dimensions In Millimeters		Dimensions In Inches	
	Min	Max	Min	Max
A	3.175	4.191	0.125	0.165
A1	1.143	1.372	0.045	0.054
b	0.406	0.533	0.016	0.021
C	0.406	0.533	0.016	0.021
D	4.445	5.207	0.175	0.205
D1	3.429	5.029	0.135	0.198
E	4.318	5.334	0.170	0.210
e	1.143	1.397	0.045	0.055
L	12.700		0.500	

3-Lead TO-92 Plastic Package

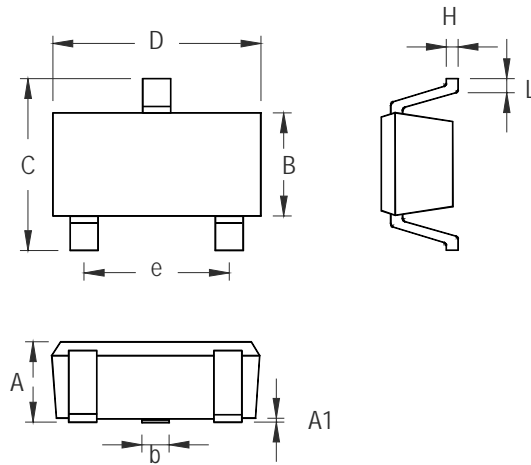

Symbol	Dimensions In Millimeters		Dimensions In Inches	
	Min	Max	Min	Max
A	0.889	1.295	0.035	0.051
A1	0.000	0.152	0.000	0.006
B	1.397	1.803	0.055	0.071
b	0.356	0.508	0.014	0.020
C	2.591	2.997	0.102	0.118
D	2.692	3.099	0.106	0.122
e	1.803	2.007	0.071	0.079
H	0.080	0.254	0.003	0.010
L	0.300	0.610	0.012	0.024

SOT-23-3 Surface Mount Package

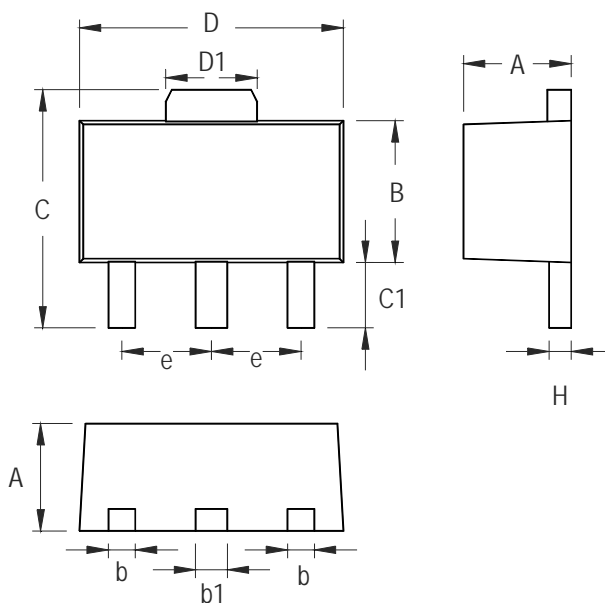

Symbol	Dimensions In Millimeters		Dimensions In Inches	
	Min	Max	Min	Max
A	1.397	1.600	0.055	0.063
b	0.356	0.483	0.014	0.019
B	2.388	2.591	0.094	0.102
b1	0.406	0.533	0.016	0.021
C	3.937	4.242	0.155	0.167
C1	0.787	1.194	0.031	0.047
D	4.394	4.597	0.173	0.181
D1	1.397	1.753	0.055	0.069
e	1.448	1.549	0.057	0.061
H	0.356	0.432	0.014	0.017

3-Lead SOT-89 Surface Mount Package