

# RX72M CPU Card with RDC-IC User's Manual

## For Your Safety



Do not fail to read this manual before using the RX72M CPU Card with RDC-IC (P/N: RTK0EMXDE0C00000BJ) (the product).

- Follow the indications in this manual when using the product.
- Keep this manual near the product so you can refer to it whenever necessary.
- Transfer or sale of the product to third parties is prohibited without written approval.
- The purchaser or importer of the product is responsible for ensuring compliance with local regulations. In addition, the customer is responsible for ensuring that the product is handled correctly and safely, in accordance with the laws of the customer's country (region).
- All information contained in this manual represents information on products at the time of publication of this manual. Please note that the product data, specification, sales offices, contents of website, address, etc., are subject to change by Renesas Electronics Corporation without notice due to product improvements or other reasons. Please confirm the latest information on Renesas Electronics website.
- The manual for the product, and specification (the documents) are the tool that was developed for the function and performance evaluation of Renesas Electronics semiconductor device (Renesas Electronics device) mounted on the product, and not guarantee the same quality, function and performance.
- By purchasing the product or downloading the documents from Renesas Electronics website, the support services provided from Renesas Electronics is not guaranteed.

## Meaning of Notations

In this manual items related to the safe use of the product are indicated as described below.

The degree of injury to persons or damage to property that could result if the designated content in this manual is not followed is indicated as follows.

 <b>Danger</b>	Indicates content that, if not followed, could result in death or serious injury*1 to the user, and which is highly urgent.
 <b>Warning</b>	Indicates content that, if not followed, could result in death or serious injury to the user.
 <b>Caution</b>	Indicates content that, if not followed, could result in injury*2 to persons or physical damage.*3

Note 1. Serious injury refers to conditions resulting in persistent after-effects and for which treatment would necessitate hospitalization or regular hospital visits, such as loss or impairment of eyesight, burns (high- or low-temperature), electric shock, bone fracture, or poisoning.

Note 2. Injury refers to conditions for which treatment would necessitate hospitalization or regular hospital visits.

Note 3. Physical damage refers to damage affecting the wider surroundings, such as the user's home or property.

Requirements related to the handling of the product are classified into the following categories.



- Marks indicating that an action is prohibited.

	<p><b>General Prohibition</b> The indicated action is prohibited.</p>		<p><b>Example: Do Not Touch!</b> Touching the specified location could result in injury.</p>
---	---	---	--

- Marks indicating that an action is prohibited.





	<p><b>General Caution</b> Indicates a general need for caution that is not specified.</p>		<p><b>Example: Caution – Hot!</b> Indicates the possibility of injury due to high temperature.</p>
---	---	---	--

- Marks directing that the specified action is required.







	<p><b>General Instruction</b> The specified action is required.</p>		<p><b>Example: Turn Off (Disconnect) Power Supply!</b> Instructs the user to turn off (disconnect) the power supply to the product.</p>
---	---	---	---

## Warnings Regarding Use of the Product





### ■ Danger Items

 <b>Danger</b>	
  	<ul style="list-style-type: none"> <li>The product should be used only by persons (users) having a thorough knowledge of electrical and mechanical components and systems, a full knowledge of the risks associated with handling them, and training in inverter motor control and handling motors, or equivalent skills. Users should be limited to persons who have carefully read the Caution Items contained in this manual.</li> <li>Unlike typical equipment, the product has no protective case to ensure safety, and it contains moving parts and high-temperature components that could be dangerous. Do not touch the evaluation board or cables while power is being supplied.</li> <li>Carefully check to make sure that there are no pieces of conductive materials or dust adhering to the board, connectors, and cables.</li> <li>There are moving parts, driven by a motor. Do not touch the motor while power is being supplied.</li> <li>Ensure that the motor is insulated and placed in a stable location before supplying power.</li> </ul>
	<p><b>Do Not Connect Load to Motor!</b></p> <ul style="list-style-type: none"> <li>This could cause fire, burns, or injury.</li> </ul>

■ Warning Items

 <b>Warning</b>	
	<p>Caution – Rotating Parts!</p> <ul style="list-style-type: none"> <li>The system includes a motor. Touching the rotating shaft could cause high-temperature burns or injury.</li> </ul>
	<p>Always insert plugs, connectors, and cables securely, and confirm that they are fully inserted.</p> <ul style="list-style-type: none"> <li>Incomplete connections could cause fire, burns, electric shock, or injury.</li> </ul>
	<p>Use the power supply apparatus specified in the manual.</p> <ul style="list-style-type: none"> <li>Failure to do so could cause fire, burns, electric shock, injury, or malfunction.</li> </ul>
	<p>Disconnect the power supply and unplug all cables when the system will not be used for a period of time or when moving the system.</p> <ul style="list-style-type: none"> <li>Failure to do so could cause fire, burns, electric shock, or malfunction.</li> <li>This will protect the system against damage due to lightning.</li> </ul>
	<p>Use a mechanism (switch, outlet, etc.) located within reach to turn off (disconnect) the power supply.</p> <ul style="list-style-type: none"> <li>In case of emergency, it may be necessary to cut off the power supply quickly.</li> </ul>
	<p>Turn off the power supply immediately if you notice abnormal odor, smoke, abnormal sound, or overheating.</p> <ul style="list-style-type: none"> <li>Continuing to use the system in an abnormal condition could cause fire, burns, or electric shock.</li> </ul>
	<p>Do Not Disassemble, Modify, or Repair!</p> <ul style="list-style-type: none"> <li>Doing so could cause fire, burns, electric shock, injury, or malfunction.</li> </ul>
	<p><b>Do not use the product for any purpose other than initial evaluation of motor control in a testing room or lab. Do not integrate the product or any part of it into other equipment. Do not insert or remove cables or connectors when the product is powered on.</b></p> <ul style="list-style-type: none"> <li>The product has no safety case.</li> <li>Failure to observe the above could cause fire, electric shock, burns, or malfunction.</li> <li>The product may not perform as expected if used for other than its intended purpose.</li> </ul>

■ Caution Items

 <b>Caution</b>	
	<p>Caution – Hot!</p> <ul style="list-style-type: none"> <li>The motor gets hot. Touching it could cause high-temperature burns.</li> </ul>
	<p>Follow the procedure specified in the manual when powering the system on or off.</p> <ul style="list-style-type: none"> <li>Failure to do so could cause overheating or malfunction.</li> </ul>
	<p>Caution – Static Electricity</p> <ul style="list-style-type: none"> <li>Use the antistatic band. Failure to do so could cause malfunction or unstable motion.</li> </ul>

## Overview

The RX72M CPU Card with RDC-IC (RTK0EMXDE0C00000BJ) is an option board for Evaluation System for BLDC Motor (RTK0EMX270S00020BJ) and Evaluation System for Stepping Motor with Resolver (RTK0EMX270S01020BJ) (hereinafter referred to as "Motor RSSK"). By attaching this product to the inverter board of Motor RSSK (hereinafter referred to as "INV-BRD"), you can evaluate the motor control with RX72M. Regarding Motor RSSK, please prepare it by yourself.

This user's manual describes the proper handling of the product.

## Target Device

RX72M microcontroller

## Related Documents

- RX72M with RDC CPU Card Schematic: R12TU0146
- RX72M with RDC CPU Card BOM List: R12TU0147
- Renesas Solution Starter Kit
  - Evaluation System for BLDC Motor User's Manual: R12UZ0062
  - Evaluation System for Stepping Motor with Resolver User's Manual: R12UZ0065

## Package Contents

Please refer to the enclosed paper "Regarding RX72M CPU Card with RDC-IC".

## Abbreviations

Abbreviations	Full Name	Remarks
Motor RSSK	Evaluation System for BLDC Motor	P/N: RTK0EMX270S00020BJ
INV-BRD	Evaluation System for Stepping Motor with Resolver	P/N: RTK0EMX270S01020BJ
INV-BRD	48V Inverter Board	Inverter board (P/N: RTK0EM0000B10020BJ) included in Evaluation System for BLDC Motor or Inverter board (P/N: RTK0EM0000B11020BJ) included in Evaluation System for Stepping Motor with Resolver
RX72M-CRD	RX72M CPU Card with RDC-IC	Optional board for INV-BRD P/N: RTK0EMXDE0C00000BJ
E2 Lite	E2 emulator Lite	On-chip debugging emulator and flash programmer P/N: RTE0T0002LKCE00000R

## Contents

1. Specifications .....	7
2. Block Diagram .....	8
3. Layout .....	9
4. Usage .....	10
4.1 Flash Writing.....	10
4.2 Connecting CPU Card.....	10
4.3 Connecting Motor and Board.....	11
4.4 Connecting Power Supply.....	11
4.5 Operation .....	12
4.6 In Case of Abnormal Odor, Smoke, Abnormal Sound, Overheating, Etc.....	12
5. Functions .....	13
5.1 Power Supply.....	13
5.2 Emulator on Board .....	13
5.3 Connecting the Inverter Board .....	13
5.4 Serial Communication .....	14
5.5 Hall Sensor Signal Input.....	15
5.6 Encoder Signal Input .....	15
5.7 Resolver Signal .....	15
5.8 EtherCAT.....	16
5.9 Reset Circuit .....	17
5.10 LEDs .....	17
6. RX72M Pin Assignment and Functions .....	18
6.1 RX72M Pin Assignments .....	18
6.2 List of RX72M Pin Functions.....	19

## Figure of contents

Figure 2-1 RX72M CPU Card with RDC-IC Block Diagram .....	8
Figure 3-1 RX72M CPU Card with RDC-IC Layout (Top View) .....	9
Figure 3-2 RX72M CPU Card with RDC-IC Layout (Bottom View) .....	9
Figure 4-1 CPU card replacement.....	10
Figure 4-2 CPU Card Connection.....	10
Figure 4-3 CPU Card Connection.....	11
Figure 4-4 Power Supply Connection .....	11
Figure 5-1 Resolver Connector.....	15
Figure 5-2 EtherCAT Connector .....	16
Figure 5-3 Reset switch .....	17
Figure 6-1 RX72M Pin Assignments.....	18

## Table of contents

Table 1-1 Specification of RX72M CPU Card with RDC-IC.....	7
Table 5-1 Pin Assignments of Inverter Board Connector (CN1) .....	13
Table 5-2 Pin Assignments of Inverter Board Connector (CN2) .....	13
Table 5-3 Pin Assignments of Inverter Board Connector (CN5) .....	14
Table 5-4 Pin Assignments of Serial Communication Connectors (CN5, CN6, CN7) .....	14
Table 5-5 Pin Assignments of Hall Sensor Signal Input Connector (CN3) .....	15
Table 5-6 Pin Assignments of Encoder Signal Input Connector (CN4) .....	15
Table 5-7 Pin Assignments of Resolver Connector (CN14) .....	16
Table 5-8 EtherCAT Communication Specification .....	16
Table 5-9 LED Pin Assignments.....	17
Table 6-1 List of RX72M Pin Functions .....	19

## 1. Specifications

**Table 1-1 Specification of RX72M CPU Card with RDC-IC**

Item	Specification
Product name	RX72M CPU Card with RDC-IC
Board product No.	RTK0EMXDE0C00000BJ
Supported inverter board	Inverter board (P/N: RTK0EM0000B10020BJ) included in Evaluation System for BLDC Motor or Inverter board (P/N: RTK0EM0000B11020BJ) included in Evaluation System for Stepping Motor with Resolver

Exterior view



Note: Appearance of actual product may differ from photo.

MCU	Product group	RX72M group
	Product No.	R5F572MNDDDB
	CPU max. operating frequency	240 MHz
	Bit count	32 bits
	Package / Pin count	LFBGA / 224 pins
	ROM	4MB
	RAM	1MB
MCU input clock		24MHz
Input power supply voltage		DC 5 V ( $\pm 5\%$ ) Selectable among the following: <ul style="list-style-type: none"> <li>• Power supply from supported inverter board</li> <li>• Power supply from USB connector</li> </ul>
Supported sensors		Resolver sensor, Hall sensor and encoder
Supported emulator		E2 On-Board (emulator on board)
Connectors		<ul style="list-style-type: none"> <li>• Emulator connector (USB)</li> <li>• Inverter board connectors x 2</li> <li>• Serial communication connectors</li> <li>• EtherCAT connector *1</li> <li>• Resolver sensor connector</li> <li>• Hall sensor connector</li> <li>• Encoder connector</li> <li>• 2nd inverter connector (unmounted)</li> </ul>
Switch		MCU external reset switch
LEDs		User control LEDs x 2
Operating temperature		Room temperature
Operating humidity		No condensation

\*1 Use a cable less than 3 m in length to connect to the EtherCAT connector of this product. (Since the EMC test of this product is conducted with the length of the cable to be connected specified as 3m or less)

2. Block Diagram

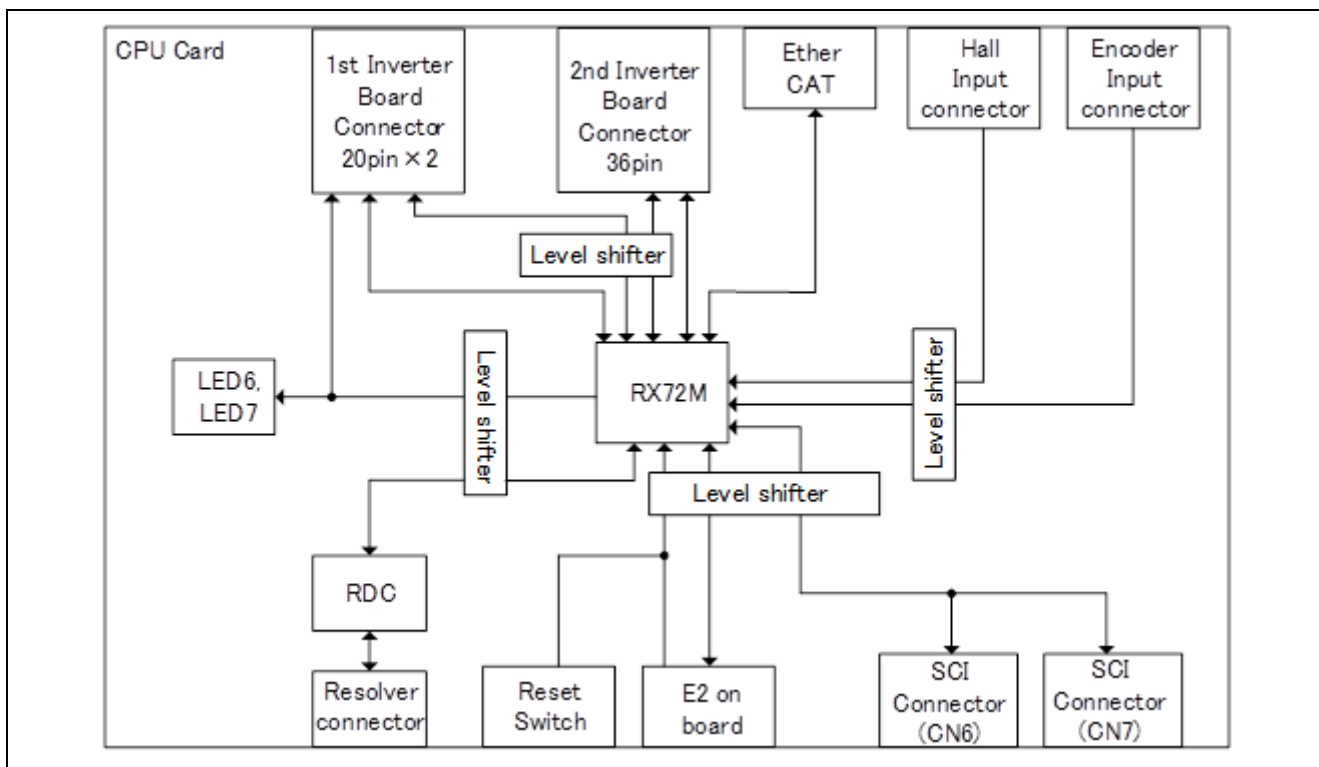

Figure 2-1 RX72M CPU Card with RDC-IC Block Diagram



### 3. Layout

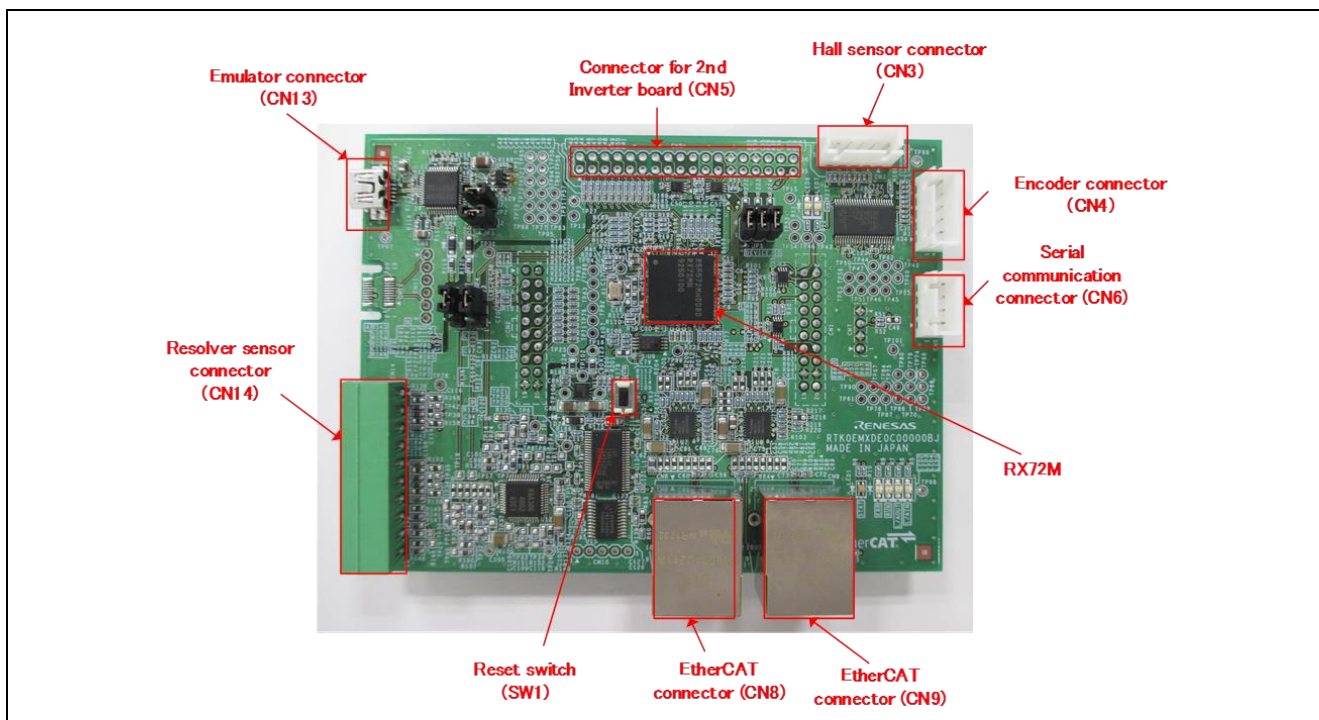

Figure 3-1 RX72M CPU Card with RDC-IC Layout (Top View)

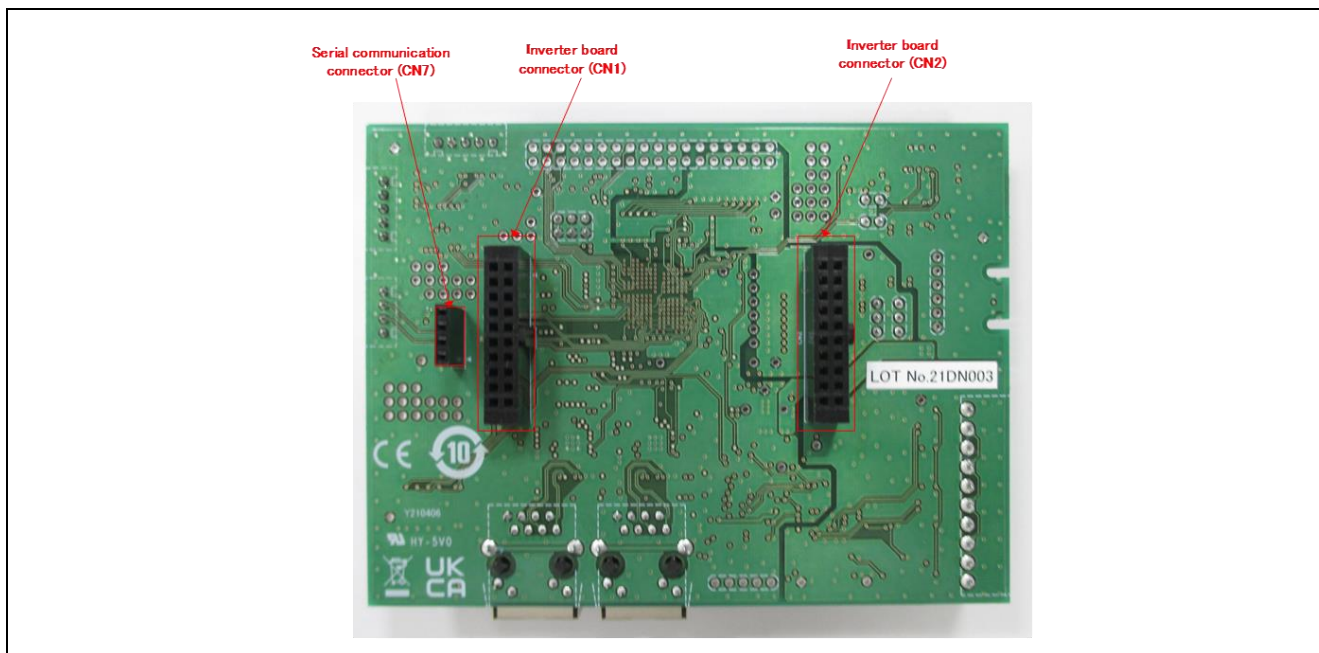

Figure 3-2 RX72M CPU Card with RDC-IC Layout (Bottom View)

## 4. Usage

### 4.1 Flash Writing

This product is equipped with an on-board emulator circuit (flash programming circuit), which enables flash writing without preparing a separate tool product. Connect the USB cable to CN13 (USB mini B connector) of the CPU card and the USB connector of the PC, and write using an application such as Renesas Flash Programmer or e2studio. When using Renesas Flash Programmer or e2studio, the on-board emulator circuit will be recognized as E2Lite, so make the connection settings accordingly.

For details on how to use each application, please refer to the respective user's manual.

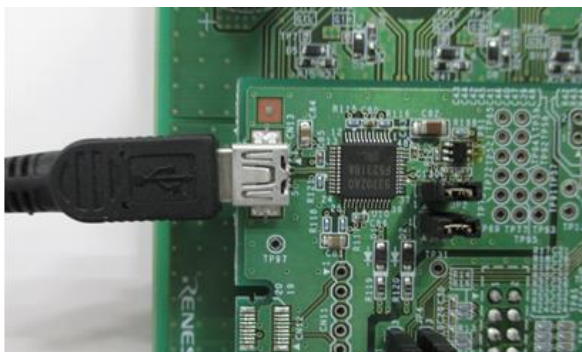

Figure 4-1 Cable connection for flash writing

### 4.2 Connecting CPU Card

#### Preparation

Prepare the following

- Stabilized power supply: Output voltage of DC24[V] or more, current limit of 1[A] can be set.
- INV-BRD: INV-BRD(RTK0EM0000B10020BJ) included in Evaluation System for BLDC Motor or INV-BRD (RTK0EM0000B11020BJ) included in Evaluation System for Stepping Motor with Resolver
- Power supply cable: Cables capable of carrying a current of 1[A] or more

Make sure that the INV-BRD is not powered on, and connect this product.

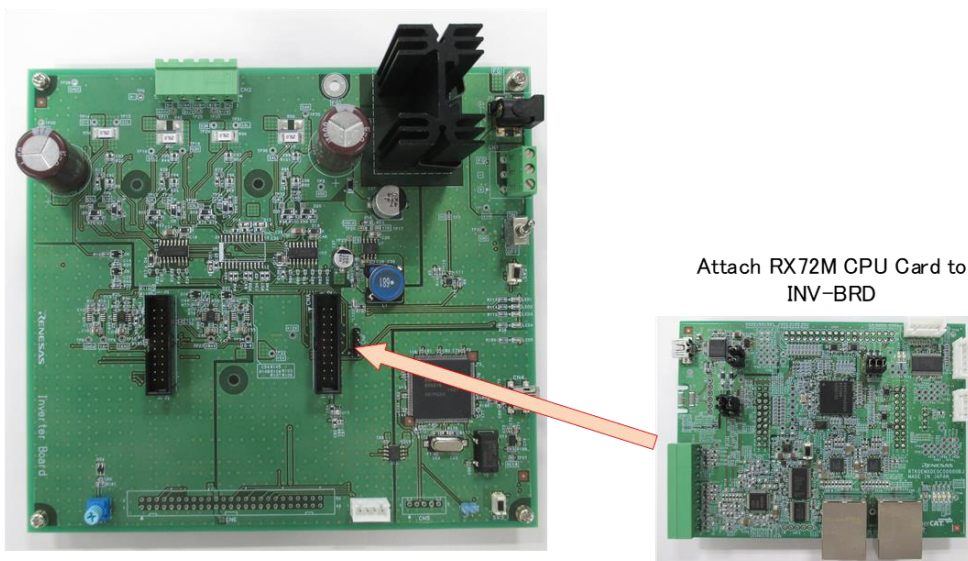

Figure 4-2 CPU Card Connection

### 4.3 Connecting Motor and Board

This product is equipped with an encoder signal input connector (CN4) and a resolver connector (CN14). Connect to the motor according to the sample code you have written in flash.

Also, connect the motor to the motor connection connector (CN2) on the INV-BRD.

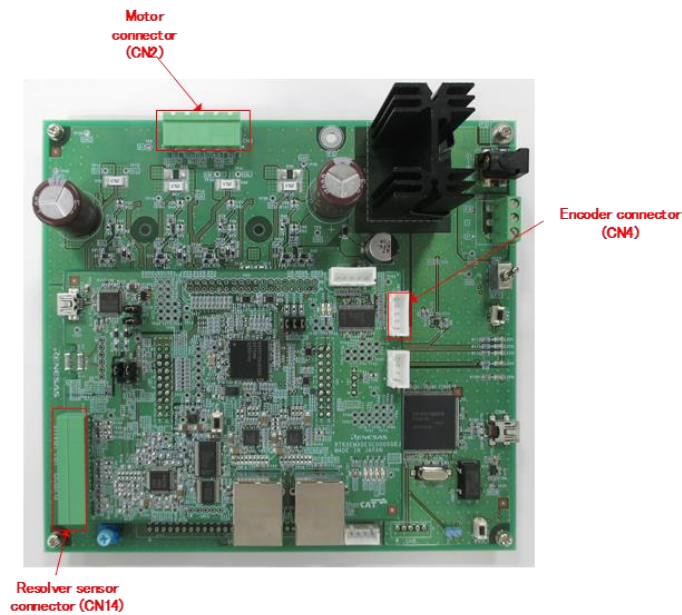

Figure 4-3 Motor and board Connection

### 4.4 Connecting Power Supply

The INV-BRD provides a terminal block (CN1) as a connector for supplying power to the board. Connect the positive output of the stabilized power supply to pin 1 ("+" silk) of CN1 and the negative output to pin 2 ("- " silk) with a cable.

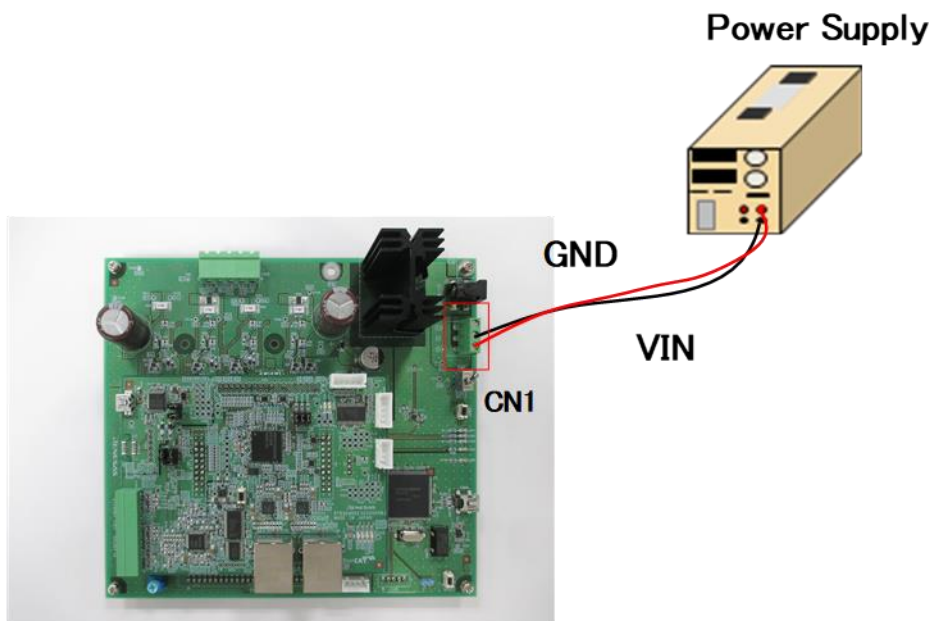

Figure 4-4 Power Supply Connection

## **4.5 Operation**

The operation of the CPU card depends on the sample code you have written. Please refer to the application note attached to the sample code for specific operation and motor control methods.

## **4.6 In Case of Abnormal Odor, Smoke, Abnormal Sound, Overheating, Etc.**

If any abnormality (strange odor, smoke, noise, heat, etc.) occurs, immediately turn off the stabilizing power supply and shut off the current flowing into the inverter.

## 5. Functions

### 5.1 Power Supply

The product does not have a dedicated power supply connector. When connected to the INV-BRD, power is supplied from INV-BRD. When not connected to the INV-BRD, power can be supplied from USB connector. When connected to INV-BRD, power is supplied from INV-BRD, so power supply from USB connector is not allowed.

### 5.2 Emulator on Board

The E2 On-Board (E2OB) onboard emulator circuit is equipped in this product, and the RX72M program can be rewritten using the E2OB. When connecting this product to the PC with USB connectors, the program can be rewritten. The E2OB functions as an emulator equivalent to E2Lite, so when connecting from the integrated development environment or Renesas Flash Programmer, set the emulator (tool) type to "E2Lite," the communication interface to "FINE," and the power supply to "Do not supply."

If you want to use only power supply from USB connector without using E2OB function, remove the short jumper of JP2 and JP3 and leave them open.

### 5.3 Connecting the Inverter Board

The product connects to the INV-BRD via the inverter board connectors (CN1 and CN2). Table 5-1 and Table 5-2 list the pin assignments of the inverter board connectors.

**Table 5-1 Pin Assignments of Inverter Board Connector (CN1)**

Pin No.	Pin Function	RX72M Connection Pins	Pin No.	Pin Function	RX72M Connection Pins
1	LED1#	P80	2	LED2#	PK2
3	LED3#	P76	4	A-L	PC6
5	OC#	PC4	6	A-H	PC7
7	B-L/WL	P86	8	B+L/VL	P87
9	A+L/UL	P17	10	B-H/WH	P21
11	B+H/VP	P22	12	A+H/UH	P23
13	SW1	PC5	14	SW2	PC3
15	5V_D	—	16	5V_D	—
17	GND_D	VSS	18	GND_D	VSS
19	NC	—	20	NC	—

**Table 5-2 Pin Assignments of Inverter Board Connector (CN2)**

Pin No.	Pin Function	RX72M Connection Pins	Pin No.	Pin Function	RX72M Connection Pins
1	+5V_A	—	2	+5V_A	—
3	I2INN_U/A+_N	—	4	I1INN_V/N+_N	—
5	I2INP_U/A+_P	AN000	6	I1INP_V/B+_P	AN001
7	IW/IB-	AN002	8	VPN	AN118
9	NC	—	10	VA+/U	AN004
11	VB+/V	AN116	12	VB-/W	AN006
13	VA-	AN115	14	IA-	AN003
15	VR	AN119	16	NC	—
17	+5V_D	—	18	+5V_D	—
19	GND_A	AVCC	20	GND_A	AVCC

This product is equipped with a 2nd inverter board connector (CN5). This connector allows you to connect another inverter board. The 2nd connector has not been mounted, so please mount it if necessary. The pin assignment of CN5 is shown in Table 5-3. Connect the corresponding pins when connecting an inverter board.

**Table 5-3 Pin Assignments of Inverter Board Connector (CN5)**

Pin No.	Pin Function	RX72M Connection Pins	Pin No.	Pin Function	RX72M Connection Pins
1	NC	—	2	VPN	AN114
3	IA+/U	AN112	4	IB+/V	AN113
5	IB-/W	AN106	6	IA-	AN107
7	VA+/U	AN108	8	VB+	AN109
9	VB-/W	AN110	10	VR	AN104
11	VA-	AN111	12	NC	—
13	LED1#	PG3	14	LED2#	PG4
15	LED3#	PG2	16	OC#	PB3
17	WN	PE4	18	B+L/VN	PE5
19	A+L	PE0	20	WP	PE3
21	B+H	PE2	22	A+H/UP	PE1
23	SW1	P65	24	SW2	PG5
25	GND_D	VSS	26	GND_D	VSS
27	NC	—	28	NC	—
29	NC	—	30	GND_D	VSS
31	B-L	P67	32	B-H	PA2
33	A-L	PA0	34	A-H	PA5
35	VRL	PG7	36	NC	—

## 5.4 Serial Communication

This product is equipped with two serial communication connectors. Table 5-4 lists their pin assignments. Use CN7 when using a tool such as waveform display in conjunction with the INV-BRD.

**Table 5-4 Pin Assignments of Serial Communication Connectors (CN6, CN7)**

Connector No.	Pin No.	Pin Function	RX72M Connection Pins
CN6	1	5V	VCC
	2	TX for MCU	PB1/TXD6
	3	RX for MCU	PB0/RXD6
	4	GND_D	VSS
CN7	1	TX for MCU	PB1/TXD6
	2	GND_D	VSS
	3	RX for MCU	PB0/RXD6
	4	GND_D	VSS

## 5.5 Hall Sensor Signal Input

This product is provided with a terminal for Hall sensor signal input. The signal input to this product is input to the RX72M via a 5V pull-up, RC filter, and level shifter. Table 5-5 lists the pin assignments of the Hall sensor signal input connector.

**Table 5-5 Pin Assignments of Hall Sensor Signal Input Connector (CN3)**

Pin No.	Pin Function	RX13T Connection Pins
1	5V	VCC
2	GND_D	VSS
3	HALL_U	P33/IRQ3
4	HALL_V	P32/IRQ2
5	HALL_W	P31/IRQ1

## 5.6 Encoder Signal Input

The product is equipped with an encoder signal input connector. Using this connector, you can input the encoder signal to the RX72M. The signals are pulled up to 5 V and passed through RC filters before being input to the RX72M. Table 5-6 lists the pin assignments of the signal input connector.

**Table 5-6 Pin Assignments of Encoder Signal Input Connector (CN4)**

Pin No.	Pin Function	RX72M Connection Pins
1	5V	VCC
2	GND	VSS
3	ENC_A	P24/MTCLKA
4	ENC_B	P25/MTCLKB
5	ENC_Z	P20/MTIOC1A

## 5.7 Resolver Signal

This product is equipped with a resolver digital converter IC (RDC IC), which converts the analog signal output of the resolver into a phase modulated digital signal output. For specifications of the RDC IC, refer to the RDC IC User's Manual (r03uz002).

The connector for connecting the resolver is a plug/socket type and can be easily removed. The location of the resolver connector (CN14) is shown in Figure 5-1, and the pin assignment of it is shown in Table 5-7.

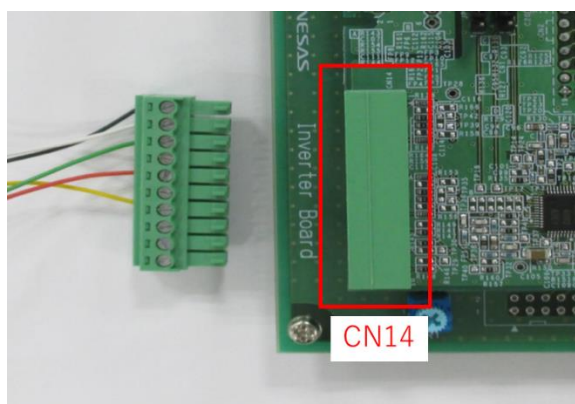

**Figure 5-1 Resolver Connector**

**Table 5-7 Pin Assignments of Resolver Connector (CN14)**

Pin No.	Signal
1	cos-
2	EXOUT1
3	cos+
4	EXOUT1
5	sin+
6	EXOUT1
7	sin-
8	EXOUT1
9	shield
10	shield

## 5.8 EtherCAT

This product is equipped with an RJ-45 connector, which can be used for EtherCAT communication. The cable to be connected to the connector should be less than 3m in length (\*).

\* Since the EMC test of this product is conducted with the length of the cable to be connected specified as 3m or less

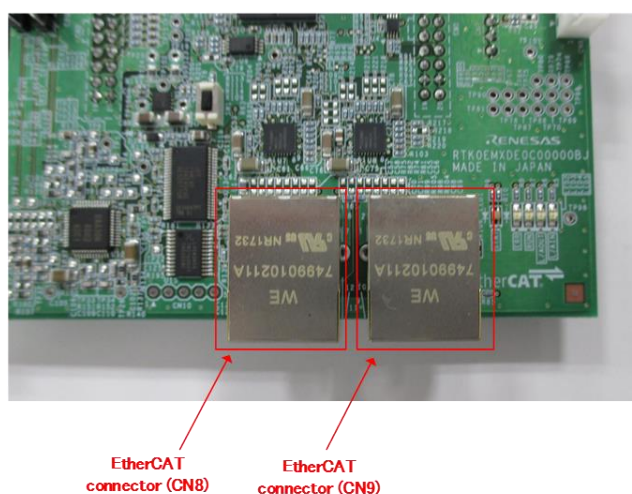

**Figure 5-2 EtherCAT Connector**

**Table 5-8 EtherCAT Communication Specification**

Item	Specification
Protocol	EtherCAT
Control IC	RX72M
Standard	IEEE802.3u (100Base-TX)
Isolation	pulse trans
Status LED	STAT (Green/Red)
	ERR (Green)
	RUN (Green)
	L/A OUT (Green)
	L/A IN (Green)
I/F	RJ45 x2



## 5.9 Reset Switch

The product is equipped with a reset switch for resetting the microcontroller externally. To apply an external reset to the microcontroller, push the pushswitch (SW1).

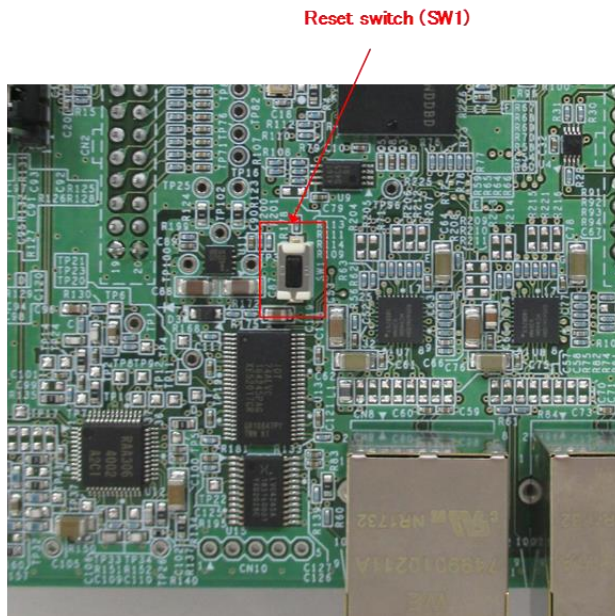

Figure 5-3 Reset switch

## 5.10 LEDs

Two LEDs (LED6, LED7) are mounted on the product for use in debugging programs and general system applications. (LED1 to LED5 are for EtherCAT.) Each turns on when the output on the corresponding port is low-level and turns off when the output is high-level. Table 5-9 lists the pin assignments corresponding to the LEDs.

Table 5-9 LED Pin Assignments

RX72M Port		LED6	LED7
P80	High-level output	Off	-
	Low-level output	On	-
PK2	High-level output	-	Off
	Low-level output	-	On

## 6. RX72M Pin Assignment and Functions

### 6.1 RX72M Pin Assignments

RX72M group LFBGA-224 (Top View)																
	A	B	C	D	E	F	G	H	J	K	L	M	N	P	R	
15	P70	PE7	P66	P67	PG4	PG7	PA4	PA5	PA7	P72	PB4	PB6	PB7	PM3	PM5	15
14	PE1	PE4	P65	PG2	PG5	PG6	PA3	PA6	PB0	PB3	PB2	PC0	PC1	PM4	P74	14
13	P62	PE2	PE5	VSS	PE6	PG3	PA2	VSS	P71	PB5	VCC	PM7	PM6	PC2	P75	13
12	P61	P63	VSS	PE3	VCC	PA0	PA1	VCC	PB1	VSS	PN4	PL6	P76	PL2	PL4	12
11	PD7	VCC	P64	PE0	PQ4	PM1	PM0	PL0	PN5	PM2	P77	PL5	PK2	PC4	PC3	11
10	PG0	PD6	P60	PG1	PQ5	VSS	VCC	P73	PL1	PL3	PL7	PK0	P80	P82	PC5	10
9	PD3	PD4	P97	PD5	PQ3	PQ6	PN2	PN3	PK3	PK1	P81	P83	PC7	VSS	PC6	9
8	P96	P95	VCC	VSS	PQ1	PN1	PQ2	PQ7	P53 (注1)	P50	P52	P51	VCC	P11	P55	8
7	PD2	P94	PD1	P93	PQ0	PK6	RES#	PJ3	P15	P10	VCC	VSS	P56	P57	P54	7
6	PD0	VCC	P90	P02	PN0	EMLE	PF5	BSCANP	PH2	PH1	PJ2	P84	PJ1	VSS_US B	USB0_D P	6
5	P92	P91	VSS	P01	P07	PK5	PJ5	P32	P30	PF0	VCC	PJ0	P13	VCC_US B	USB0_D M	5
4	P41	P46	P44	P40	P43	PK4	MD/ FINED	P33	P31	PH5	P24	VSS	P85	P14	P12	4
3	VREFL0	P42	P05	P03	P00	PF4	VCC	P35	PF3	PH4	PF1	P25	P86	P20	P16	3
2	VREFH0	AVCC0	AVCC1	P47	VSS	VBATT	VSS	P34	PF2	PH6	P27	P23	PH0	P17	P87	2
1	NC	AVSS0	AVSS1	P45	VCL	XCIN	XCOU	XTAL	EXTAL	PH7	PH3	P26	P22	PK7	P21	1
	A	B	C	D	E	F	G	H	J	K	L	M	N	P	R	

Figure 6-1 RX72M Pin Assignments

## 6.2 List of RX72M Pin Functions

Table 6-1 List of RX72M Pin Functions

Pin No.	RX72M Pin Functions	Function	Use
A2	VREFH0		VREFH0
A3	VREFL0		VREFL0
A4	P41/IRQ9/AN001	AN001	1st INV V/B+ current detection
A5	P92/D18/A18/POE4#/RXD7/SMISO7/SSCL7/ET1_CRS/RMII1_CRS_DV/CAT1_RX_DV/AN116/DSMCLK4	AN116	1st INV V/B+ phase voltage detection
A6	PDO/D0/POE4#/GTIOC1B/LCD_EXTCLK-B/IRQ0/AN108	AN108	2nd INV U/A+ phase voltage detection
A7	PD2/D2/MTIOC4D/TIC2/GTIOC0B/MISOC-A/CRX0/ET1_EXOUT/QIO2-B/SDHI_D2-B/MMC_D2-B/LCD_DATA22-B/IRQ2/AN110	AN110	2nd INV W/B- phase voltage detection
A8	P96/TRDATA5/D22/A22/ET1_ERXD2/CAT1_ERXD2		
A9	PD3/D3/MTIOC8D/TOC2/POE8#/GTIOCOA/RSPCKC-A/ET1_WOL/QIO3-B/SDHI_D3-B/MMC_D3-B/LCD_DATA21-B/IRQ3/AN111	AN111	2nd INV A- phase voltage detection
A10	PG0/TRDATA6/D24/ET1_RX_CLK/REF50CK1/CAT1_RX_CLK		
A11	PD7/D7/MTIC5U/POE0#/SSLC3-A/ET1_RX_ER/RMII1_RX_ER/CAT1_RX_ER/QMI-B/QIO1-B/SDHI_D1-B/MMC_D1-B/LCD_DATA17-B/IRQ7/AN107	AN107	2nd INV A-current detection
A12	P61/SDCS#/D0/CS1#/ET1_ERXD1/RMII1_RXD1/CAT1_ERXD1		
A13	P62/RAS#/D1/CS2#/ET1_ERXD0/RMII1_RXD0/CAT1_ERXD0		
A14	PE1/D9/D1/MTIOC4C/MTIOC3B/PO18/GTIOC1B/TXD12/SMOSI12/SSDA12/TXD12/SIOX12/SSLB2-B/MMC_D5-B/LCD_DATA15-B/ANEX1	MTIOC3B	2nd INV A+H/2nd INV UH
A15	P70/SDCLK/CATLINKACTO		
B1	AVSS0		AVSS0
B2	AVCC0		AVCC0
B3	P42/IRQ10/AN002	AN002	1st INV W/B-current detection
B4	P46/IRQ14/AN006	AN006	1st INV W/B- phase voltage detection
B5	P91/D17/A17/SCK7/ET1_COL/AN115/DSMDAT5	AN115	1st INV A- phase voltage detection
B6	VCC		VCC
B7	P94/D20/A20/ET1_ERXD0/RMII1_RXD0/CAT1_ERXD0		
B8	P95/TRDATA4/D21/A21/ET1_ERXD1/RMII1_RXD1/CAT1_ERXD1		
B9	PD4/D4/MTIOC8B/POE11#/SSLC0-A/ET1_MDIO/PMGI1_MDIO/QSSL-B/SDHI_CMD-B/MMC_CMD-B/LCD_DATA20-B/IRQ4/AN112	AN112	2nd INV U/A+ current detection
B10	PD6/D6/MTIC5V/MTIOC8A/POE4#/SSLC2-A/ET1_RX_CLK/REF50CK1/CAT1_RX_CLK/QM0-B/QIO0-B/SDHI_D0-B/MMC_D0-B/LCD_DATA18-B/IRQ6/AN106	AN106	2nd INV W/B-current detection
B11	VCC		VCC
B12	P63/CAS#/D2/CS3#/ET1_ETXD1/RMII1_TXD1/CAT1_ETXD1		
B13	PE2/D10/D2/MTIOC4A/PO23/TIC3/GTIOC0B/RXD12/SMISO2/SSCL12/RDX12/SSLB3-B/MMC_D6-B/LCD_DATA14-B/IRQ7/AN100	MTIOC4A	2nd INV B+H/2nd INV VH

Pin No.	RX72M Pin Functions	Function	Use
B14	PE4/D12/D4/MTIOC4D/MTIOC1A/P028/GTIOC1A/SSLB0-B/ETO_ERXD2/CATO_ERXD2/LCD_DATA12-B/AN102	MTIOC4D	2nd INV WL
B15	PE7/D15/D7/MTIOC6A/TOC1/GTIOC3A/MISOB-B/SDHI_WP/MMC_RES#-B/LCD_DATA9-B/IRQ7/AN105		
C1	AVSS1		AVSS1
C2	AVCC1		AVCC1
C3	P05/SSILRCK1/IRQ13/DA1		
C4	P44/IRQ12/AN004	AN004	1st INV U/A+ phase voltage detection
C5	VSS		VSS
C6	P90/D16/A16/TXD7/SMOS17/SSDA7/ET1_RX_DV/CAT1_RX_DV/AN114/DSMCLK5	AN114	2nd INV bus voltage detection
C7	PD1/D1/MTIOC4B/POE0#/GTIOC1A/MOSIC-A/CTX0/LCD_DATA23-B/IRQ1/AN109	AN109	2nd INV V/B+ phase voltage detection
C8	VCC		VCC
C9	P97/TRSYNC1/D23/A23/ET1_ERXD3/CAT1_ERXD3		
C10	P60/CS0#/ET1_TX_EN/RMII1_TXD_EN/CAT1_TX_EN		
C11	P64/WE#/D3/CS4#/ET1_ETXD0/RMII1_TXD0/CAT1_ETXD0		
C12	VSS		VSS
C13	PE5/D13/D5/MTIOC4C/MTIOC2B/GTIOC0A/RSPCKB-B/ETO_RX_CLK/REF50CKO/CATO_RX_CLK/LCD_DATA11-B/IRQ5/AN103	MTIOC4C	2nd INV B+L/2nd INV VL
C14	P65/CKE/CS5#	P65	2nd INV _SW1
C15	P66/DQM0/CS6#/MTIOC7D/GTIOC2B/CTX2		
D1	P45/IRQ13/AN005	AN005	RDC_MNTOUT_DC
D2	P47/IRQ15/AN007	AN007	RDC_MNTOUT_AC
D3	P03/SSIDATA1/IRQ11/DAO		
D4	P40/IRQ8/AN000	AN000	1st INV U/A+ current detection
D5	P01/TMC10/RXD6/SMIS06/SSCL6/SSIBCK0/CATLEDERR/Q103-C/IRQ9/AN119	AN117	1st INV _VR
D6	P02/TMC11/SCK6/SSIBCK1/CATLEDSTER/IRQ10/AN120		
D7	P93/D19/A19/POE0#/CTS7#/RTS7#/SS7#/ET1_LINKSTA/CAT1_LINKSTA/AN117/DSMSTAT4		
D8	VSS		VSS
D9	PD5/D5/MTIC5W/MTIOC8C/MTCLKA/POE10#/SSLC1-A/ET1_MDC/PMGI1_MDC/QSPCLK-B/SDHI_CLK-B/MMC_CLK-B/LCD_DATA19-B/IRQ5/AN113	AN113	2nd INV V/B+ current detection
D10	PG1/TRDATA7/D25/ET1_RX_ER/RMII1_RX_ER/CAT1_RX_ER		
D11	PE0/D8/D0/MTIOC3D/GTIOC2B/SCK12/SSLB1-B/MMC_D4-B/LCD_DATA16-B/ANEX0	MTIOC3D	2nd INV A+L/2nd INV UL
D12	PE3/D11/D3/MTIOC4B/P026/TOC3/POE8#/GTIOC2A/CTS12#/RTS12#/SS12#/ETO_ERXD3/CATO_ERXD3/MMC_D7-B/LCD_DATA13-B/AN101	MTIOC4B	2nd INV WH
D13	VSS		VSS
D14	PG2/TRDATA0/D26/ET1_TX_CLK/CAT1_TX_CLK	PG2	2nd INV _LED3
D15	P67/DQM1/CS7#/MTIOC7C/GTIOC1B/CRX2/EPLSOUT1/CATSYNC1/IRQ15	MTIOC7C	2nd INV B-L
E1	VCL		VCL
E2	VSS		VSS
E3	P00/TMR10/TXD6/SMOS16/SSDA6/AUDIO_CLK/CATLATCH1/QI02-C/IRQ8/AN118	AN118	1st INV bus voltage detection

Pin No.	RX72M Pin Functions	Function	Use
E4	P43/IRQ11/AN003	AN003	1st INV A-current detection
E5	P07/IRQ15/ADTRGO#		
E6	PN0/ET1_ETXD2/CAT1_ETXD2	CAT1_ETXD2	CAT1_ETXD2
E7	PQ0/SCK11/ET1_GRS/RMII1_GRS_DV/CAT1_RX_DV	ET1_GRS	CAT1_CONFIG1
E8	PQ1/SMISO11/SSCL11/RXD11/ET1_COL	ET1_COL	CAT1_CONFIG0
E9	PQ3/RTS11#/CTS11#/SS11#/ET1_TX_ER		
E10	PQ5/ET1_ETXD0/RMII1_TXD0/CAT1_ETXD0	CAT1_ETXD0	CAT1_ETXD0
E11	PQ4/ET1_RX_CLK/REF50CK1/CAT1_RX_CLK	CAT1_RX_CLK	CAT1_BCAST_OFF
E12	VCC		VCC
E13	PE6/D14/D6/MTIOC6C/TIC1/GTIOC3B/MOSIB-B/SDHI_CD/MMC_CD-B/LCD_DATA10-B/IRQ6/AN104	AN104	2nd INV_VR
E14	PG5/TRCLK/D29/ET1_ETXD2/CAT1_ETXD2	PG5	2nd INV_SW2
E15	PG4/TRSYNC/D28/ET1_ETXD1/RMII1_TXD1/CAT1_ETXD1	PG4	2nd INV_LED2
F1	XCIN	XCIN	XCIN
F2	VBATT		VBATT
F3	PF4/TRST#	TRST#	E1, TRST#
F4	PK4/GTADSM0/SSLB1/ETO_ERXD2/CATO_ERXD2	CATO_ERXD2	CATO_PHYAD1
F5	PK5/GTADSM1/SSLB2/ETO_ERXD3/CATO_ERXD3	CATO_ERXD3	CATO_PHYAD0
F6	EMLE	EMLE	E1, EMLE 端子
F7	PK6/GTIOC1A/SSLB3/CATLINKACTO	CATLINKACTO	CATLINKACTO
F8	PN1/ET1_ETXD3/CAT1_ETXD3	CAT1_ETXD3	CAT1_ETXD3
F9	PQ6/ET1_ETXD1/RMII1_TXD1/CAT1_ETXD1	CAT1_ETXD1	CAT1_ETXD1
F10	VSS		VSS
F11	PM1/TOC3/GTETRGB/SMISO10/SSCL10/RXD10/ET1_ERXD1/RMII1_RXD1/CAT1_ERXD1/SDHI_CMD-D/QSSL-A	CAT1_ERXD1	CAT1_PHYAD2
F12	PA0/DQM2/BC0#/AO/MTIOC4A/MTIOC6D/TIOCA0/PO16/CACREF/GTIOC0B/SSLA1-B/ETO_TX_EN/RMII0_TXD_EN/CATO_TX_EN/CATLEDRUN/LCD_DATA8-B	MTIOC6D	2nd INV A-L
F13	PG3/TRDATA1/D27/ET1_ETXD0/RMII1_TXD0/CAT1_ETXD0	PG3	2nd INV_LED1
F14	PG6/TRDATA2/D30/ET1_ETXD3/CAT1_ETXD3		
F15	PG7/TRDATA3/D31/ET1_TX_ER	PG7	2nd INV_VRL
G1	XCOUT	XCOUT	XCOUT
G2	VSS		VSS
G3	VCC		VCC
G4	MD/FINED	MD/FINED	E1, MD/FINED
G5	PJ5/POE8#/CTS2#/RTS2#/SS2#/SSIRXD0/EPLSOUT0/CATSYNCO/QMI-C/QI01-C	CATSYNCO	CATSYNCO
G6	PF5/WAIT#/SSILRCK0/CATLATCH0/IRQ4	IRQ4	CAT1_INTRP
G7	RES#	RES#	RESET
G8	PQ2/SMOSI11/SSDA11/TXD11/ET1_RX_DV/CAT1_RX_DV	CAT1_RX_DV	CAT1_CONFIG2
G9	PN2/ET1_TX_CLK/CAT1_TX_CLK	CAT1_TX_CLK	CAT1_TX_CLK
G10	VCC		VCC
G11	PM0/TIC3/GTETRGA/SCK10/ET1_ERXD0/RMII1_RXD0/CAT1_ERXD0/SDHI_CLK-D/QSPCLK-A	CAT1_ERXD0	CAT1_DUPLEX
G12	PA1/DQM3/A1/MTIOC0B/MTCLKC/MTIOC7B/TIOCBO/PO17/GTIOC2A/SCK5/SSLA2-B/ETO_WOL/LCD_DATA7-B/IRQ11	MTIOC0B	RDC_CARRIER1
G13	PA2/A2/MTIOC7A/PO18/GTIOC1A/RXD5/SMISO5/SSCL5/SSLA3-B/CATLINKACT1/LCD_DATA6-B	MTIOC7A	2nd INV B-H

Pin No.	RX72M Pin Functions	Function	Use
G14	PA3/A3/MTIOC0D/MTCLKD/TIOC0D/TCLKB/PO19/RXD5/SMIS05/SSCL5/ETO_MDIO/CATO_MDIO/PMGIO_MDIO/LCD_DATA5-B/IRQ6	MTIOC0D	RDC_CARRIER2
G15	PA4/A4/MTIC5U/MTCLKA/TIOCA1/TMRIO/PO20/TXD5/SMOSI5/SSDA5/SSLA0-B/ETO_MDC/CATO_MDC/CATIRQ/PMGIO_MDC/LCD_DATA4-B/IRQ5	CATIRQ	CATIRQ
H1	P37/XTAL	XTAL	Crystal
H2	P34/MTIOC0A/TMC13/PO12/POE10#/SCK6/SCK0/ETO_LINKSTA/CATO_LINKSTA/IRQ4/DSMDATO	CATO_LINKSTA	CATO_LINKSTA
H3	P35/UPSEL/NMI		
H4	P33/EDREQ1/MTIOC0D/TIOC0D/TMR13/PO11/POE4#/POE11#/RXD6/SMIS06/SSCL6/RXD0/SMIS00/SSCL0/CRX0/PCK0/IRQ3/DSMCLK0	IRQ3	HALL_U
H5	P32/MTIOC0C/TIOC0C/TM03/PO10/RTCIC2/RTCOUT/POE0#/POE10#/TXD6/SMOSI6/SSDA6/TXD0/SMOSI0/SSDA0/CTX0/USBO_VBUSEN/VSYNC/IRQ2	IRQ2	HALL_V
H6	BSCANP	BSCANP	BSCANP
H7	PJ3/EDACK1/MTIOC3C/CTS6#/RTS6#/SS6#/CTS0#/RTS0#/S0#/SSITXD0/ETO_EXOUT/CATRESTOUT/QMO-C/QI00-C		
H8	PQ7/ET1_TX_EN/RMII1_TXD_EN/CAT1_TX_EN	CAT1_TX_EN	CAT1_TX_EN
H9	PN3/ET1_RX_ER/RMII1_RX_ER/CAT1_RX_ER	CAT1_RX_ER	CAT1_ISO
H10	P73/GS3#/PO16/ETO_WOL/LCD_EXTCLK-A		
H11	PLO/TIC2/GTETRGA/SCK9/RSPCKC/ETO_ERXD0/RMII0_RXD0/CATO_ERXD0		
H12	VCC		VCC
H13	VSS		VSS
H14	PA6/A6/MTIC5V/MTCLKB/TIOCA2/TMC13/PO22/POE10#/GTE TRGB/CTS5#/RTS5#/SS5#/MOSIA-B/ETO_EXOUT/CATRESTOUT/LCD_DATA2-B	CATRESETOUT	CATO/CAT1_CATRESTOUT
H15	PA5/A5/MTIOC6B/TIOC6B/PO21/GTIOC0A/RSPCKA-B/ETO_LINKSTA/CATO_LINKSTA/LCD_DATA3-B	MTIOC6B	2nd INV A-H
J1	P36/EXTAL	EXTAL	Crystal
J2	PF2/TDI/RXD1/SMIS01/SSCL1/CATI2CCLK	TDI	E1, TDI
J3	PF3/TMS	TMS	E1, TMS
J4	P31/MTIOC4D/TMC12/PO9/RTCIC1/CTS1#/RTS1#/SS1#/SSLB0-A/ET1_MDC/PMGI1_MDC/IRQ1	IRQ1	HALL_W
J5	P30/MTIOC4B/TMR13/PO8/RTCIC0/POE8#/RXD1/SMIS01/SSCL1/MISOB-A/ET1_MDIO/PMGI1_MDIO/IRQ0	POE8#	RDC_ALARM
J6	PH2/GTETRGC/SMOSI7/SSDA7/TXD7/MISOA/CATI2CDATA	CATI2CDATA	CATI2CDATA
J7	P15/MTIOC0B/MTCLKB/TIOC62/TCLKB/TMC12/PO13/GTETRGA/RXD1/SMIS01/SSCL1/SCK3/CRX1/SSILRCK1/CATLEDRUN/PIXD0/IRQ5	CATLEDRUN	CATLEDRUN
J8	P53/BCLK		
J9	PK3/GTETRGD/RTS8#/CTS8#/SS8#/SSLB0/ETO_TX_ER		
J10	PL1/TOC2/GTETRGB/SMIS09/SSCL9/RXD9/MOSIC/ETO_ERXD1/RMII0_RXD1/CATO_ERXD1		
J11	PN5/ET1_MDC/PMGI1_MDC/QSSL-C		
J12	PB1/A9/MTIOC0C/MTIOC4C/TIOC63/TMC10/PO25/TXD4/SMOSI4/SSDA4/TXD6/SMOSI6/SSDA6/ETO_ERXD0/RMII0_RXD0/CATO_ERXD0/LCD_TCON3-B/IRQ4	TXD6	Renesas Motor Workbench

## RX72M CPU Card with RDC-IC User's Manual

Pin No.	RX72M Pin Functions	Function	Use
J13	P71/A18/CS1#/ETO_MDIO/CATO_MDIO/PMGIO_MDIO/DSMCLK3		
J14	PB0/A8/MTIC5W/TIOCA3/PO24/RXD4/SMIS04/SSCL4/RXD6/SMIS06/SSCL6/ETO_ERXD1/RMII0_RXD1/CATO_ERXD1/LCD_DATA0-B/IRQ12	RXD6	Renesas Motor Workbench
J15	PA7/A7/TIOCB2/PO23/MIS0A-B/ETO_WOL/LCD_DATA1-B		
K1	PH7/CLKOUT25M/GTIOC0B	CLKOUT25M	CLKOUT25M
K2	PH6/CLKOUT/GTIOC0A/SSLA3/CATLATCH1	CATLATCH1	CATLATCH1
K3	PH4/GTADSM0/SSLA1/CATLEDSTER	CATLEDSTER	CATLEDSTER
K4	PH5/GTADSM1/SSLA2/CATLATCH0	CATLATCH0	CATLATCH0
K5	PF0/TD0/TXD1/SMOSI1/SSDA1/CATI2CDATA	TD0	E1, TD0
K6	PH1/TOC0/GTETRGB/SMIS07/SSCL7/RXD7/MOSIA/CATI2CLKK	CATI2CCLK	CATI2CCLK
K7	P10/ALE/MTIC5W/TMRI3/IRQ0	IRQ0	CATO_INTRP
K8	P50/WRO#/WR#/TXD2/SMOSI2/SSDA2/SSLB1-A/CATLEDERR		
K9	PK1/TOC1/GTETRGB/SMIS08/SSCL8/RXD8/MOSIB/ETO_COL	ETO_COL	CATO_CONFIG0
K10	PL3/GTETRGD/RTS9#/CTS9#/SS9#/SSLC0/ETO_RX_CLK/REF50CK0/CATO_RX_CLK	CATO_RX_CLK	CATO_BCAST_OFF
K11	PM2/GTETRGC/SMOSI10/SSDA10/TXD10/ET1_ERXD2/CAT1_ERXD2/SDHI_D0-D/QM0-A/Q100-A	CAT1_ERXD2	CAT1_PHYAD1
K12	VSS		VSS
K13	PB5/A13/MTIOC2A/MTIOC1B/TIOCB4/TMRI1/PO29/POE4#/SCK9/RTS9#/SCK11/ETO_ETXD0/RMII0_TXD0/CATO_ETXD0/LCD_CLK-B	MTIOC1B	RDC_COUT
K14	PB3/A11/MTIOC0A/MTIOC4A/TIOC0D3/TCLKD/TM00/PO27/POE11#/SCK4/SCK6/ETO_RX_ER/RMII0_RX_ER/CATO_RX_ER/LCD_TCON1-B	POE11#	2nd INV_OC
K15	P72/A19/CS2#/ETO_MDC/CATO_MDC/PMGIO_MDC/LCD_DATA23-A/DSMDAT3		
L1	PH3/GTETRGD/RTS7#/CTS7#/SS7#/SSLA0/CATLEDERR	CATLEDERR	CATLEDERR
L2	P27/CS7#/MTIOC2B/TMC13/PO7/SCK1/RSPCKB-A/ET1_WOL/CATIRQ	MTIOC2B	RDC_CC
L3	PF1/TCK/SCK1	TCK	E1, TCK
L4	P24/CS4#/EDREQ1/MTIOC4A/MTCLKA/TIOCB4/TMRI1/PO4/SCK3/USB0_VBUSEN/SSIBCK1/SDHI_WP/PIXCLK	MTCLKA	ENC_A
L5	VCC		VCC
L6	PJ2/CLKOUT25M/TXD8/SMOSI8/SSDA8/SSLC3-B/LCD_TCON2-A		
L7	VCC		VCC
L8	P52/RD#/RXD2/SMIS02/SSCL2/SSLB3-A/CATLEDSTER		
L9	P81/EDACK0/MTIOC3D/PO27/GTIOC0B/SMIS010/SSCL10/RXD10/ETO_ETXD0/RMII0_TXD0/CATO_ETXD0/CATI2CCLK/QIO3-A/SDHI_CD/MMC_D3-A/LCD_DATA13-A		
L10	PL7/GTIOC2B/ETO_MDIO/CATO_MDIO/PMGIO_MDIO	CATO_MDIO	CATO_MDIO
L11	P77/CS7#/PO23/SMOSI11/SSDA11/TXD11/ETO_RX_ER/RMII0_RX_ER/CATO_RX_ER/QSPCLK-A/SDHI_CLK-A/MMC_CLK-A/LCD_DATA17-A		
L12	PN4/ET1_MDIO/PMGI1_MDIO/QSPCLK-C		
L13	VCC		VCC

Pin No.	RX72M Pin Functions	Function	Use
L14	PB2/A10/TIOCC3/TCLKC/PO26/CTS4#/RTS4#/SS4#/CTS6#/RTS6#/SS6#/ETO_RX_CLK/REF50CK0/CATO_RX_CLK/LCD_TC ON2-B		
L15	PB4/A12/TIOCA4/PO28/CTS9#/SS9#/SS11#/CTS11#/RTS11#/ETO_TX_EN/RMII0_TXD_EN/CATO_TX_EN/LCD_TCON0-B	PB4	Device ID1
M1	P26/CS6#/MTIOC2A/TMO1/PO6/TXD1/SMOSI1/SSDA1/CTS3#/RTS3#/SS3#/MOS1B-A/ET1_EXOUT/CATLINKACT1	TMO1	RDC_PWMINA
M2	P23/EDACK0/MTIOC3D/MTCLKD/TIOCD3/PO3/GTIOCOA/TXD3/SMOSI3/SSDA3/CTS0#/RTS0#/SS0#/CTX1/SSIBCK0/SDHI_D1-C/PIXD7	GTIOCOA	1st INV A+H/1st INV UH
M3	P25/CLKOUT/CS5#/EDACK1/MTIOC4C/MTCLKB/TIOCA4/PO5/RXD3/SMISO3/SSLC3/SSIDATA1/SDHI_CD/HSYNC/ADTRG0#	MTCLKB	ENC_B
M4	VSS		VSS
M5	PJ0/MTIOC6B/SCK8/SSLC1-B/EPLSOUT0/CATSYNCO/LCD_DATA0-A		
M6	P84/MTIOC6D/ET1_LINKSTA/CAT1_LINKSTA/LCD_DATA2-A	CAT1_LINKSTA	CAT1_LINKSTA
M7	VSS		VSS
M8	P51/WR1#/BC1#/WAIT#/SCK2/SSLB2-A		
M9	P83/EDACK1/MTIOC4C/GTIOCOA/SCK10/SS10#/CTS10#/ETO_CRS/RMII0_CRS_DV/CATO_RX_DV/LCD_DATA8-A/DSMCLK1		
M10	PK0/TIC1/GTETRGA/SCK8/RSPCKB/ETO_MDC/CATO_MDC/PMG IO_MDC	CATO_MDC	CATO_MDC
M11	PL5/GTADSM1/SSLC2/ETO_ETXD1/RMII0_TXD1/CATO_ETXD1	CATO_ETXD1	CATO_ETXD1
M12	PL6/GTIOC2A/SSLC3/ETO_TX_EN/RMII0_TXD_EN/CATO_TX_EN	CATO_TX_EN	CATO_TX_EN
M13	PM7/GTIOC3B/ETO_CRS/RMII0_CRS_DV/CATO_RX_DV/SDHI_WP	ETO_CRS	CATO_CONFIG1
M14	PC0/A16/MTIOC3C/TCLKC/PO17/CTS5#/RTS5#/SS5#/SSLA1-A/ETO_ERXD3/CATO_ERXD3/IRQ14		
M15	PB6/A14/MTIOC3D/TIOCA5/PO30/RXD9/SMISO9/SSCL9/SMISO11/SSCL11/RXD11/ETO_ETXD1/RMII0_TXD1/CATO_ETXD1	PB6	Device ID2
N1	P22/EDREQ0/MTIOC3B/MTCLKC/TIOCC3/TMO0/PO2/GTIOC1A/SCK0/USBO_OVRCURB/AUDIO_CLK/SDHI_D0-C/PIXD6	GTIOC1A	1st INV B+H/1st INV VH
N2	PH0/TIC0/GTETRGA/SCK7/RSPCKA/CATLEDRUN		
N3	P86/MTIOC4D/TIOCA0/GTIOC2B/SMISO10/SSCL10/RXD10/CATLINKACT0/PIXD1	GTIOC2B	1st INV B-L/1st INV WL
N4	P85/MTIOC6C/TIOCC0/LCD_DATA1-A		
N5	P13/WR2#/BC2#/MTIOCOB/TIOCA5/TMO3/PO13/GTADSM1/TXD2/SMOSI2/SSDA2/SDA0/LCD_TCON0-A/IRQ3/ADTRG1#	TMO3	RDC_PWMINB
N6	PJ1/MTIOC6A/RXD8/SMISO8/SSCL8/SSLC2-B/EPLSOUT1/CATSYNCO/LCD_TCON3-A		
N7	P56/CLKOUT25M/EDACK1/MTIOC3C/TIOCA1/SCK7/RSPCKC-B/LCD_DATA4-A/DSMDAT1	RSPCKC	RDC_SPI
N8	VCC		VCC
N9	PC7/UB/A23/CS0#/MTIOC3A/MTCLKB/TMO2/PO31/TOCO/CACREF/GTIOC3A/TXD8/SMOSI8/SSDA8/SMOSI10/SSDA10/TXD10/MISOA-A/ETO_COL/MMC_D7-A/LCD_DATA9-A/IRQ14	GTIOC3A	1st INV A-H
N10	P80/EDREQ0/MTIOC3B/PO26/SCK10/RTS10#/ETO_TX_EN/RMII0_TXD_EN/CATO_TX_EN/CATLATCH0/QIO2-A/SDHI_WP/MMC_D2-A/LCD_DATA14-A	P80	1st INV_LED1



Pin No.	RX72M Pin Functions	Function	Use
N11	PK2/GTETRGC/SMOSI8/SSDA8/TXD8/MISOB/ETO_RX_DV/CAT0_RX_DV	PK2	1st INV_LED2
N12	P76/CS6#/PO22/SMISO11/SSCL11/RXD11/ETO_RX_CLK/REF50CK0/CATO_RX_CLK/QSSL-A/SDHI_CMD-A/MMC_CMD-A/LCD_DATA18-A	P76	1st INV_LED3
N13	PM6/GTIOC3A/ETO_TX_CLK/CATO_TX_CLK/SDHI_CD	CATO_TX_CLK	CATO_TX_CLK
N14	PC1/A17/MTIOC3A/TCLKD/PO18/SCK5/SSLA2-A/ETO_ERXD2/CATO_ERXD2/LCD_DATA22-A/IRQ12		
N15	PB7/A15/MTIOC3B/TIOCB5/PO31/TXD9/SMOSI9/SSDA9/SMOSI11/SSDA11/TXD11/ETO_CRS/RMII0_CRS_DV/CATO_RX_DV	PB7	Device ID3
P1	PK7/GTIOC1B/CATLINKACT1	CATLINKACT1	CATLINKACT1
P2	P17/MTIOC3A/MTIOC3B/MTIOC4B/TIOCBO/TCLKD/TMO1/PO15/POE8#/GTIOCB/SCK1/TXD3/SMOSI3/SSDA3/SDA2/SSITXD0/EPLSOUT0/CATSYNCO/SDHI_D3-C/PIXD3/IRQ7/ADTRG1#	GTIOCB	1st INV A+L/1st INV UL
P3	P20/MTIOC1A/TIOCB3/TMR10/PO0/TXD0/SMOSIO/SSDA0/SDA1/USBO_ID/SSIRXD0/SDHI_CMD-C/PIXD4/IRQ8	MTIOC1A	ENC_Z
P4	P14/MTIOC3A/MTCLKA/TIOCB5/TCLKA/TMR12/PO15/GTETRGD/CTS1#/RTS1#/SS1#/CTX1/USBO_OVRCURA/LCD_CLK-A/IRQ4	P14	RDC_RESET#
P5	VCC_USB		VCC_USB
P6	VSS_USB		VSS_USB
P7	P57/RXD7/SMISO7/SSCL7/SSLC0-B/LCD_DATA3-A	SSLC0	RDC_SPI
P8	P11/MTIC5V/TMC13/SCK2/EPLSOUT1/CATSYNCO/LCD_DATA7-A/IRQ1	CATSYNCO	CATSYNCO
P9	VSS		VSS
P10	P82/EDREQ1/MTIOC4A/PO28/GTIOC2A/SMOSI10/SSDA10/TXD10/ETO_ETXD1/RMII0_TXD1/CATO_ETXD1/CATI2CDATA/MMC_D4-A/LCD_DATA12-A	P82	1st INV_VRL
P11	PC4/A20/CS3#/MTIOC3D/MTCLKC/TMC11/PO25/POE0#/GTETRGC/SCK5/CTS8#/SS8#/SS10#/CTS10#/RTS10#/SSLA0-A/ETO_TX_CLK/CATO_TX_CLK/CATSYNCO/QMI-A/QIO1-A/SDHI_D1-A/MMC_D1-A/LCD_DATA15-A	POE0#	1st INV_OC
P12	PL2/GTETRGC/SMOSI9/SSDA9/TXD9/MISOC/ETO_RX_ER/RMII0_RX_ER/CATO_RX_ER	CATO_RX_ER	CATO_ISO
P13	PC2/A18/MTIOC4B/TCLKA/PO21/GTIOC2B/RXD5/SMISO5/SSCL5/SSLA3-A/ETO_RX_DV/CATO_RX_DV/SDHI_D3-A/MMC_CD-A/LCD_DATA19-A	CATO_RX_DV	CATO_CONFIG2
P14	PM4/GTADSMO/ETO_ETXD2/CATO_ETXD2/SDHI_D2-D/QIO2-A	CATO_ETXD2	CATO_ETXD2
P15	PM3/GTETRGD/RTS10#/CTS10#/SS10#/ET1_ERXD3/CAT1_ERXD3/SDHI_D1-D/QMI-A/QIO1-A	CAT1_ERXD3	CAT1_PHYADO
R1	P21/MTIOC1B/MTIOC4A/TIOCA3/TMCIO/PO1/GTIOC2A/RXD0/SMISO0/SSCLO/SCL1/USBO_EXIGEN/SSILRCK0/SDHI_CLK-C/PIXD5/IRQ9	GTIOC2A	1st INV B-H/1st INV WH
R2	P87/MTIOC4C/TIOCA2/GTIOC1B/SMOSI10/SSDA10/TXD10/EPLSOUT1/CATSYNCO/SDHI_D2-C/PIXD2	GTIOC1B	1st INV B+L/1st INV VL
R3	P16/MTIOC3C/MTIOC3D/TIOCB1/TCLKC/TMO2/PO14/RTCOUT/TXD1/SMOSI1/SSDA1/RXD3/SMISO3/SSCL3/SCL2/USBO_VBUS/USBO_VBUS/USBO_OVRCURB/IRQ6/ADTRGO#	TMO2	RDC_CLK
R4	P12/WR3#/BC3#/MTIC5U/TMC11/GTADSMO/RXD2/SMISO2/SSCL2/SCL0/LCD_TCON1-A/IRQ2		
R5	USBO_DM		USBO_DM

## RX72M CPU Card with RDC-IC User's Manual

Pin No.	RX72M Pin Functions	Function	Use
R6	USB0_DP		USB0_DP
R7	P54/D1/EDACK0/ALE/MTIOC4B/TMC11/CTS2#/RTS2#/SS2#/ MOSIC-B/CTX1/ETO_LINKSTA/CATO_LINKSTA/LCD_DATA6-A	MOSIC	RDC_SPI
R8	P55/D0/EDREQ0/WAIT#/MTIOC4D/TM03/TXD7/SMOSI7/SSDA 7/MISOC-B/CRX1/ETO_EXOUT/LCD_DATA5-A/IRQ10	MISOC	RDC_SPI
R9	PC6/D2/A22/CS1#/MTIOC3C/MTCLKA/TMC12/P030/TICO/GT IOC3B/RXD8/SMIS08/SSCL8/SMIS010/SSCL10/RXD10/MOSI A-A/ETO_ETXD3/CATO_ETXD3/CATLATCH1/MMC_D6- A/LCD_DATA10-A/IRQ13	GTIOC3B	1st INV A-L
R10	PC5/D3/A21/CS2#/WAIT#/MTIOC3B/MTCLKD/TMR12/P029/G TIOC1A/SCK8/RTS8#/SCK10/RSPCKA- A/ETO_ETXD2/CATO_ETXD2/MMC_D5-A/LCD_DATA11-A	PC5	1st INV_SW1
R11	PC3/A19/MTIOC4D/TCLKB/P024/GTIOC1B/TXD5/SMOSI5/SS DA5/ETO_TX_ER/QM0-A/QI00-A/SDHI_DO-A/MMC_DO- A/LCD_DATA16-A	PC3	1st INV_SW2
R12	PL4/GTADSM0/SSLC1/ETO_ETXD0/RMII0_TXD0/CATO_ETXD0	CATO_ETXD0	CATO_ETXD0
R13	P75/CS5#/P020/SCK11/RTS11#/ETO_ERXD0/RMII0_RXD0/C ATO_ERXD0/SDHI_D2-A/MMC_RES#-A/LCD_DATA20- A/DSMDAT2	CATO_ERXD0	CATO_DUPLEX
R14	P74/A20/CS4#/P019/SS11#/CTS11#/ETO_ERXD1/RMII0_RX D1/CATO_ERXD1/LCD_DATA21-A/DSMCLK2	CATO_ERXD1	CATO_PHYAD2
R15	PM5/GTADSM1/ETO_ETXD3/CATO_ETXD3/SDHI_D3-D/QI03-A	CATO_ETXD3	CATO_ETXD3

### Website and Support

Renesas Electronics Website

<http://www.renesas.com/>

Inquiries

<http://www.renesas.com/contact/>

All trademarks and registered trademarks are the property of their respective owners.