

# RA6M3 Group

Graphics Evaluation Kit for RA6M3 Microcontroller Group  
EK-RA6M3G  
Quick Start Guide

Renesas RA Family  
RA6 Series

All information contained in these materials, including products and product specifications, represents information on the product at the time of publication and is subject to change by Renesas Electronics Corp. without notice. Please review the latest information published by Renesas Electronics Corp. through various means, including the Renesas Electronics Corp. website (<http://www.renesas.com>).

## Notice

1. Descriptions of circuits, software and other related information in this document are provided only to illustrate the operation of semiconductor products and application examples. You are fully responsible for the incorporation or any other use of the circuits, software, and information in the design of your product or system. Renesas Electronics disclaims any and all liability for any losses and damages incurred by you or third parties arising from the use of these circuits, software, or information.
2. Renesas Electronics hereby expressly disclaims any warranties against and liability for infringement or any other claims involving patents, copyrights, or other intellectual property rights of third parties, by or arising from the use of Renesas Electronics products or technical information described in this document, including but not limited to, the product data, drawings, charts, programs, algorithms, and application examples.
3. No license, express, implied or otherwise, is granted hereby under any patents, copyrights or other intellectual property rights of Renesas Electronics or others.
4. You shall be responsible for determining what licenses are required from any third parties, and obtaining such licenses for the lawful import, export, manufacture, sales, utilization, distribution or other disposal of any products incorporating Renesas Electronics products, if required.
5. You shall not alter, modify, copy, or reverse engineer any Renesas Electronics product, whether in whole or in part. Renesas Electronics disclaims any and all liability for any losses or damages incurred by you or third parties arising from such alteration, modification, copying or reverse engineering.
6. Renesas Electronics products are classified according to the following two quality grades: "Standard" and "High Quality". The intended applications for each Renesas Electronics product depends on the product's quality grade, as indicated below.

"Standard": Computers; office equipment; communications equipment; test and measurement equipment; audio and visual equipment; home electronic appliances; machine tools; personal electronic equipment; industrial robots; etc.

"High Quality": Transportation equipment (automobiles, trains, ships, etc.); traffic control (traffic lights); large-scale communication equipment; key financial terminal systems; safety control equipment; etc.

Unless expressly designated as a high reliability product or a product for harsh environments in a Renesas Electronics data sheet or other Renesas Electronics document, Renesas Electronics products are not intended or authorized for use in products or systems that may pose a direct threat to human life or bodily injury (artificial life support devices or systems; surgical implantations; etc.), or may cause serious property damage (space system; undersea repeaters; nuclear power control systems; aircraft control systems; key plant systems; military equipment; etc.). Renesas Electronics disclaims any and all liability for any damages or losses incurred by you or any third parties arising from the use of any Renesas Electronics product that is inconsistent with any Renesas Electronics data sheet, user's manual or other Renesas Electronics document.
7. No semiconductor product is absolutely secure. Notwithstanding any security measures or features that may be implemented in Renesas Electronics hardware or software products, Renesas Electronics shall have absolutely no liability arising out of any vulnerability or security breach, including but not limited to any unauthorized access to or use of a Renesas Electronics product or a system that uses a Renesas Electronics product. RENESAS ELECTRONICS DOES NOT WARRANT OR GUARANTEE THAT RENESAS ELECTRONICS PRODUCTS, OR ANY SYSTEMS CREATED USING RENESAS ELECTRONICS PRODUCTS WILL BE INVULNERABLE OR FREE FROM CORRUPTION, ATTACK, VIRUSES, INTERFERENCE, HACKING, DATA LOSS OR THEFT, OR OTHER SECURITY INTRUSION ("Vulnerability Issues"). RENESAS ELECTRONICS DISCLAIMS ANY AND ALL RESPONSIBILITY OR LIABILITY ARISING FROM OR RELATED TO ANY VULNERABILITY ISSUES. FURTHERMORE, TO THE EXTENT PERMITTED BY APPLICABLE LAW, RENESAS ELECTRONICS DISCLAIMS ANY AND ALL WARRANTIES, EXPRESS OR IMPLIED, WITH RESPECT TO THIS DOCUMENT AND ANY RELATED OR ACCOMPANYING SOFTWARE OR HARDWARE, INCLUDING BUT NOT LIMITED TO THE IMPLIED WARRANTIES OF MERCHANTABILITY, OR FITNESS FOR A PARTICULAR PURPOSE.
8. When using Renesas Electronics products, refer to the latest product information (data sheets, user's manuals, application notes, "General Notes for Handling and Using Semiconductor Devices" in the reliability handbook, etc.), and ensure that usage conditions are within the ranges specified by Renesas Electronics with respect to maximum ratings, operating power supply voltage range, heat dissipation characteristics, installation, etc. Renesas Electronics disclaims any and all liability for any malfunctions, failure or accident arising out of the use of Renesas Electronics products outside of such specified ranges.
9. Although Renesas Electronics endeavors to improve the quality and reliability of Renesas Electronics products, semiconductor products have specific characteristics, such as the occurrence of failure at a certain rate and malfunctions under certain use conditions. Unless designated as a high reliability product or a product for harsh environments in a Renesas Electronics data sheet or other Renesas Electronics document, Renesas Electronics products are not subject to radiation resistance design. You are responsible for implementing safety measures to guard against the possibility of bodily injury, injury or damage caused by fire, and/or danger to the public in the event of a failure or malfunction of Renesas Electronics products, such as safety design for hardware and software, including but not limited to redundancy, fire control and malfunction prevention, appropriate treatment for aging degradation or any other appropriate measures. Because the evaluation of microcomputer software alone is very difficult and impractical, you are responsible for evaluating the safety of the final products or systems manufactured by you.
10. Please contact a Renesas Electronics sales office for details as to environmental matters such as the environmental compatibility of each Renesas Electronics product. You are responsible for carefully and sufficiently investigating applicable laws and regulations that regulate the inclusion or use of controlled substances, including without limitation, the EU RoHS Directive, and using Renesas Electronics products in compliance with all these applicable laws and regulations. Renesas Electronics disclaims any and all liability for damages or losses occurring as a result of your noncompliance with applicable laws and regulations.
11. Renesas Electronics products and technologies shall not be used for or incorporated into any products or systems whose manufacture, use, or sale is prohibited under any applicable domestic or foreign laws or regulations. You shall comply with any applicable export control laws and regulations promulgated and administered by the governments of any countries asserting jurisdiction over the parties or transactions.
12. It is the responsibility of the buyer or distributor of Renesas Electronics products, or any other party who distributes, disposes of, or otherwise sells or transfers the product to a third party, to notify such third party in advance of the contents and conditions set forth in this document.
13. This document shall not be reprinted, reproduced or duplicated in any form, in whole or in part, without prior written consent of Renesas Electronics.
14. Please contact a Renesas Electronics sales office if you have any questions regarding the information contained in this document or Renesas Electronics products.

(Note1) "Renesas Electronics" as used in this document means Renesas Electronics Corporation and also includes its directly or indirectly controlled subsidiaries.

(Note2) "Renesas Electronics product(s)" means any product developed or manufactured by or for Renesas Electronics.

(Rev.5.0-1 October 2020)

## Corporate Headquarters

TOYOSU FORESIA, 3-2-24 Toyosu,  
Koto-ku, Tokyo 135-0061, Japan  
[www.renesas.com](http://www.renesas.com)

## Trademarks

Renesas and the Renesas logo are trademarks of Renesas Electronics Corporation. All trademarks and registered trademarks are the property of their respective owners.

## Contact information

For further information on a product, technology, the most up-to-date version of a document, or your nearest sales office, please visit:  
[www.renesas.com/contact/](http://www.renesas.com/contact/).

## Renesas EK-RA6M3G Disclaimer

By using this EK-RA6M3G, the User accepts the following terms, which are in addition to, and control in the event of disagreement, with Renesas' General Terms and Conditions available at <https://www.renesas.com/en-us/legal/disclaimer.html>.

The EK-RA6M3G is not guaranteed to be error free, and the entire risk as to the results and performance of the EK-RA6M3G is assumed by the User. The EK-RA6M3G is provided by Renesas on an "as is" basis without warranty of any kind whether express or implied, including but not limited to the implied warranties of good workmanship, fitness for a particular purpose, title, merchantability, and non-infringement of intellectual property rights. Renesas expressly disclaims any implied warranty.

Renesas does not consider the EK-RA6M3G to be a finished product and therefore the EK-RA6M3G may not comply with some requirements applicable to finished products, including, but not limited to recycling, restricted substances and electromagnetic compatibility regulations. Refer to Certifications section, for information about certifications and compliance information for the EK-RA6M3G. It is the kit User's responsibility to make sure the kit meets any local requirements applicable to their region.

Renesas or its affiliates shall in no event be liable for any loss of profit, loss of data, loss of contract, loss of business, damage to reputation or goodwill, any economic loss, any reprogramming or recall costs (whether the foregoing losses are direct or indirect) nor shall Renesas or its affiliates be liable for any other direct or indirect special, incidental or consequential damages arising out of or in relation to the use of this EK-RA6M3G, even if Renesas or its affiliates have been advised of the possibility of such damages.

Renesas has used reasonable care in preparing the information included in this document, but Renesas does not warrant that such information is error free nor does Renesas guarantee an exact match for every application or parameter to part numbers designated by other vendors listed herein. The information provided in this document is intended solely to enable the use of Renesas products. No express or implied license to any intellectual property right is granted by this document or in connection with the sale of Renesas products. Renesas reserves the right to make changes to specifications and product descriptions at any time without notice. Renesas assumes no liability for any damages incurred by you resulting from errors in or omissions from the information included herein. Renesas cannot verify, and assumes no liability for, the accuracy of information available on another company's website.

## Precautions

This Evaluation Kit is only intended for use in a laboratory environment under ambient temperature and humidity conditions. A safe separation distance should be used between this and any sensitive equipment. Its use outside the laboratory, classroom, study area, or similar such area invalidates conformity with the protection requirements of the Electromagnetic Compatibility Directive and could lead to prosecution.

The product generates, uses, and can radiate radio frequency energy and may cause harmful interference to radio communications. There is no guarantee that interference will not occur in a particular installation. If this equipment causes harmful interference to radio or television reception, which can be determined by turning the equipment off or on, you are encouraged to try to correct the interference by one or more of the following measures:

- Ensure attached cables do not lie across the equipment.
- Reorient the receiving antenna.
- Increase the distance between the equipment and the receiver.
- Connect the equipment into an outlet on a circuit different from that which the receiver is connected.
- Power down the equipment when not in use.
- Consult the dealer or an experienced radio/TV technician for help.

Note: It is recommended that wherever possible shielded interface cables are used.

The product is potentially susceptible to certain EMC phenomena. To mitigate against them it is recommended that the following measures be undertaken:

- The user is advised that mobile phones should not be used within 10 m of the product when in use.
- The user is advised to take ESD precautions when handling the equipment.

The Evaluation Kit does not represent an ideal reference design for an end product and does not fulfill the regulatory standards for an end product.

## Renesas RA Family

**EK-RA6M3G****Contents**

1. Introduction.....	5
1.1 Assumptions and Advisory Notes.....	5
2. Kit Contents.....	5
3. Overview of the Quick Start Example Project.....	6
3.1 Quick Start Example Project Flow.....	6
4. Running the Quick Start Example Project.....	6
4.1 Connecting and Powering Up the EK-RA6M3G Kit.....	6
4.2 Running the Quick Start Example Project.....	7
5. Next Steps.....	10
6. Website and Support.....	12
Revision History.....	13

**Figures**

Figure 1. EK-RA6M3G Kit Contents.....	5
Figure 2. Quick Start Example Project Flow.....	6
Figure 3. Splash Screen with Pictures.....	7
Figure 4. Splash Screen with Welcome Text.....	7
Figure 5. QR Code Screen.....	8
Figure 6. Clock Screen.....	8
Figure 7. Washing Machine Interface Screen.....	9
Figure 8. Weather Forecast Screen.....	9
Figure 9. Movie Demo.....	11
Figure 10. Weather Forecast Demo.....	11

## 1. Introduction

This Quick Start Guide (QSG) provides:

- An overview of the Quick Start example project that the EK-RA6M3G kit comes pre-programmed with.
- Instructions for running the Quick Start example project.

### 1.1 Assumptions and Advisory Notes

1. Prior to running the Quick Start example project on the EK-RA6M3 board, default jumper settings must be used. Refer to the EK-RA6M3G user's manual for the default jumper settings.
2. The screen shots provided throughout this document are for reference. The actual screen content may differ depending on the version of the software used.

## 2. Kit Contents

The following components are included in the kit:

1. EK-RA6M3 board
2. Graphics Expansion Board
3. Micro USB device cable (type-A male to micro-B male)
4. Micro USB host cable (type-A female to micro-B male)
5. Ethernet patch cable

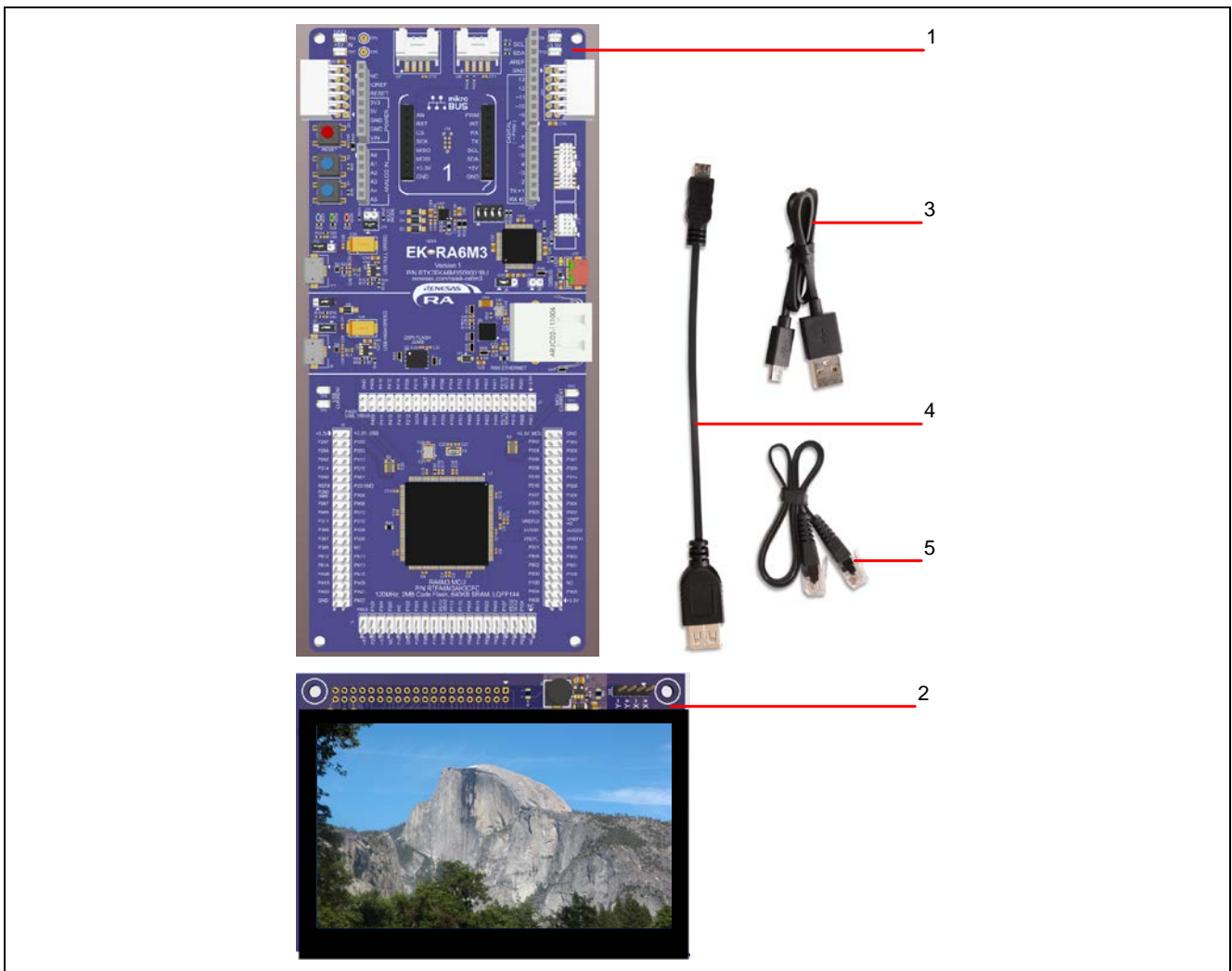

Figure 1. EK-RA6M3G Kit Contents

### 3. Overview of the Quick Start Example Project

The Quick Start example project demonstrates the graphics manipulation capabilities of the integrated Graphics LCD Controller and JPEG Decoder modules of the RA6M3 MCU Group using a HMI developed using emWin, the embedded GUI from SEGGER.

emWin uses the drawing engine (Dave2D) of the RA6M3 to perform operations such as drawing bitmaps, anti-aliased shapes, and filling rectangular areas. emWin also routes JPEG decoding using the integrated JPEG Decoder to allow for fast drawing of JPEGs, emWin movie files (EMFs), and AVIs.

The example project HMI consists of four screens. The user can switch between each screen by swiping left/right or pressing one of the navigation buttons.

#### 3.1 Quick Start Example Project Flow

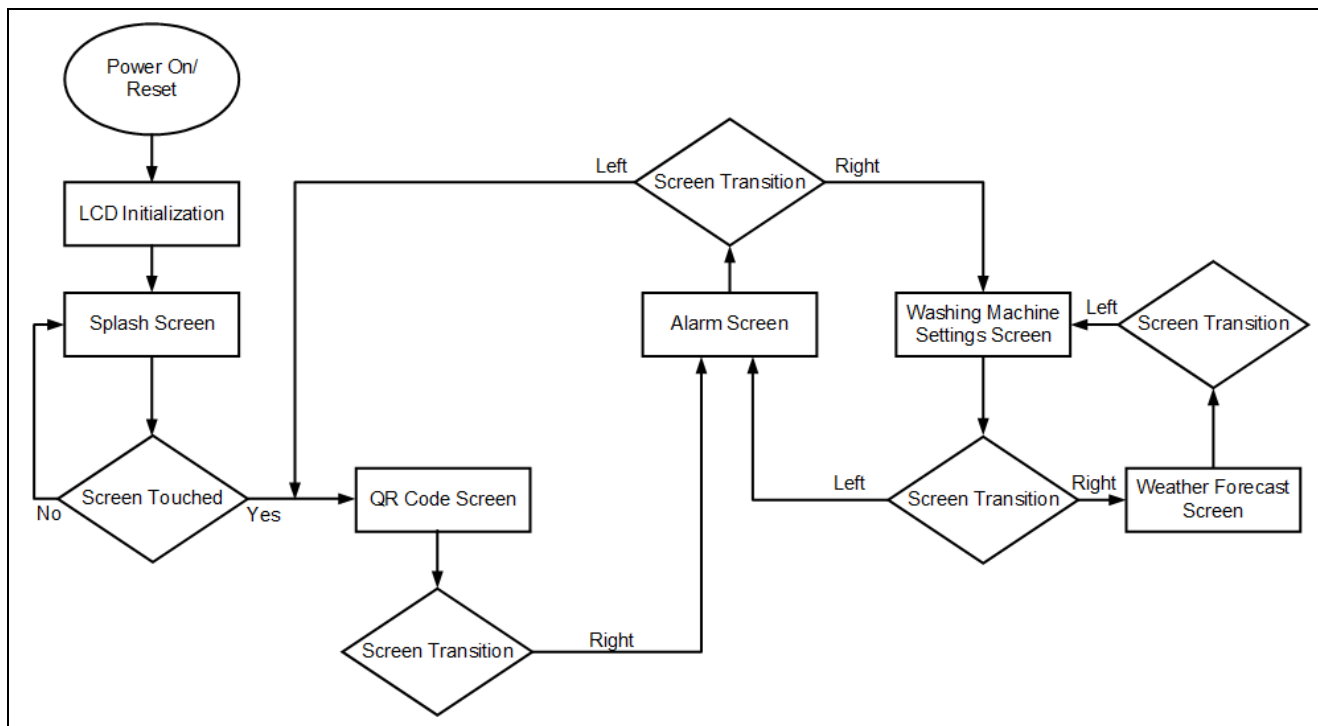

Figure 2. Quick Start Example Project Flow

### 4. Running the Quick Start Example Project

This section lists the requirements and instructions to power up the EK-RA6M3G kit and run the Quick Start example project.

#### Hardware Requirements

- EK-RA6M3 board
- Graphics Expansion Board
- Micro USB device cable
- A 5 V power source with a USB port

#### 4.1 Connecting and Powering Up the EK-RA6M3G Kit

1. Connect the Graphics Expansion Board to the graphics expansion port (J1) of the EK-RA6M3 board. Make sure to align the arrows printed on the back of each of the two boards.
2. Connect the micro USB end of the micro USB device cable to any one of the micro USB ports (J6, J10, or J11) of the EK-RA6M3 board.
3. Connect the other end of this cable to the USB port of the 5 V power supply. The power LED (LED4) on the EK-RA6M3 board will light up white, indicating that the EK-RA6M3 board is powered on.

## 4.2 Running the Quick Start Example Project

To run the Quick Start example project, use the following instructions:

1. On power up or RESET, the Quick Start example project programmed on the EK-RA6M3 board will begin to execute first showing a splash screen with pictures followed by welcome text.



Figure 3. Splash Screen with Pictures

2. Once the welcome text appears, touch the LCD screen to go to the QR code screen.

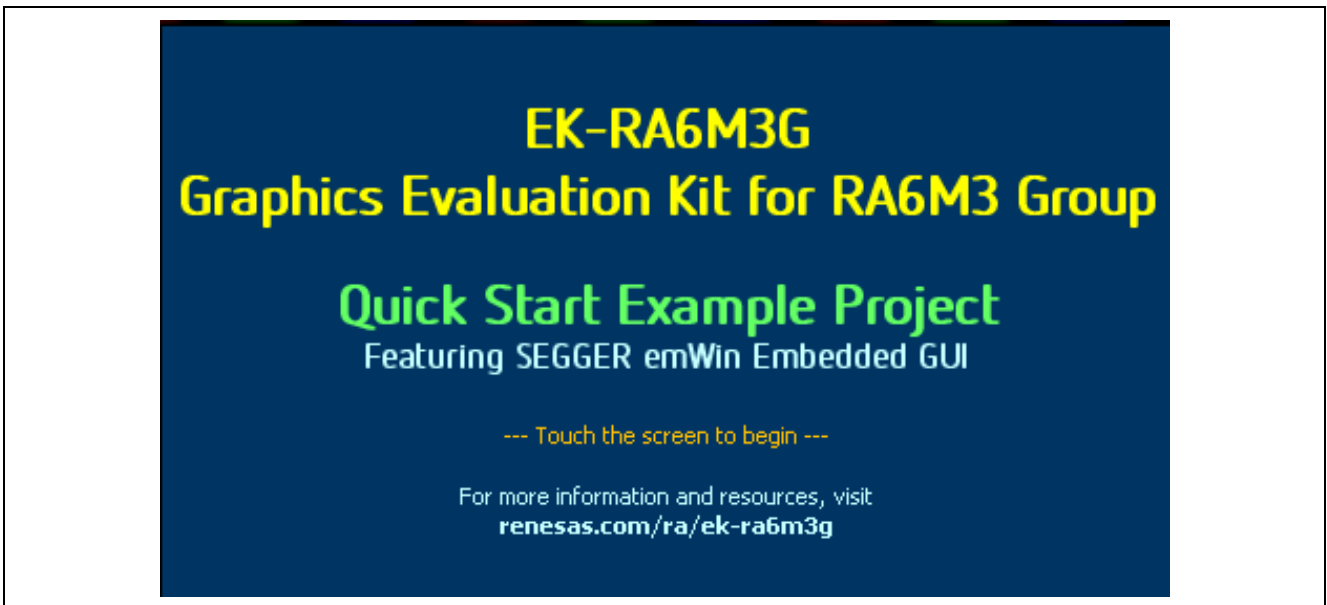

Figure 4. Splash Screen with Welcome Text

3. The QR code screen shows the two QR codes generated on runtime with emWin. These codes can be scanned with a QR code reader such as a cell phone with a QR code scanner app. The QR codes point to Renesas and SEGGER's websites.



Figure 5. QR Code Screen

4. Swipe towards left (or press the navigation arrow on the top right corner of the screen) to navigate to the alarm screen.

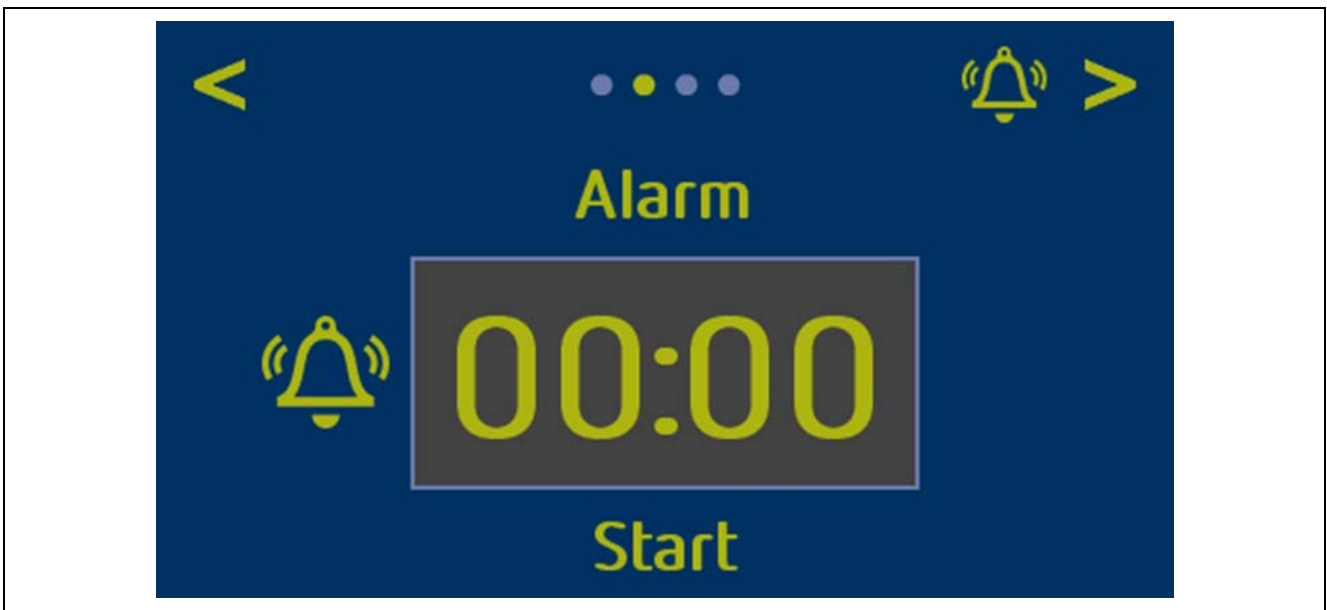
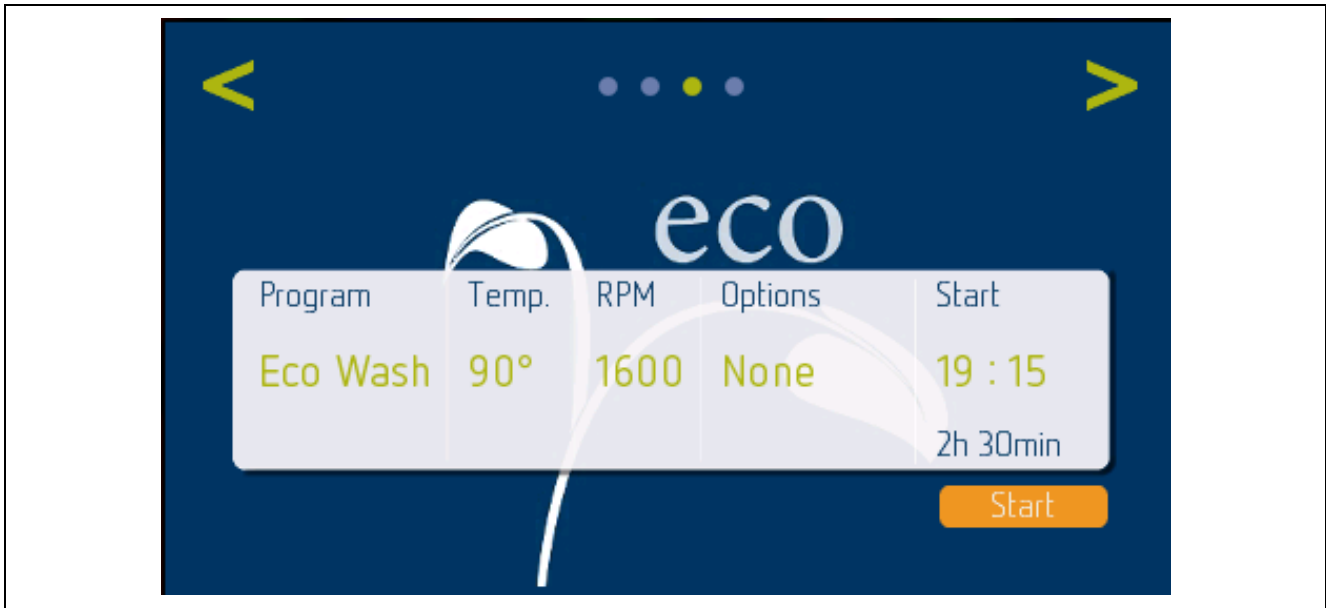

Figure 6. Clock Screen

5. The alarm screen shows a simple alarm clock that can be set by swiping the numbers up or down and started by pressing the **Start** button. The timer will start to count down, even if the screen is not the current screen. Once it reaches zero, a small bell will show up in the top right corner. Pressing this bell will reset the alarm.



6. Swipe towards left (or press the navigation arrow on the top right corner of the screen) to navigate to the washing machine interface. Or swipe towards right (or press the navigation arrow on the top left corner of the screen) to navigate back to the alarm screen.



**Figure 7. Washing Machine Interface Screen**

7. The washing machine interface provides options to select different programs, temperatures, options, and so forth. It makes use of the JPEG decoder to display the images in the background. This can help save memory for example, by comparing a JPEG image with a size of ~28 KB to a raw 16-bpp image with a size of ~200 KB.
8. Swipe towards left (or press the navigation arrow on the top right corner of the screen) to navigate to the weather forecast screen. Or swipe towards right (or press the navigation arrow on the top left corner of the screen) to navigate back to the washing machine interface screen.

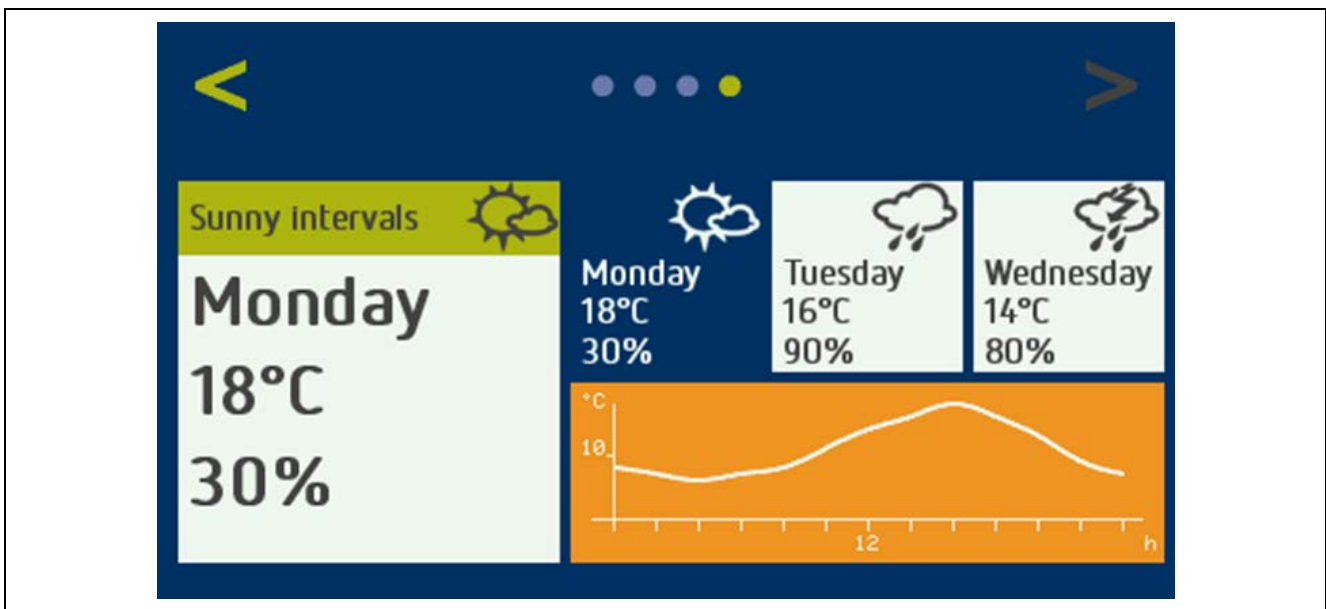

**Figure 8. Weather Forecast Screen**

9. The weather screen shows a weather forecast interface. It uses alpha bitmaps which can be drawn in any color. It also shows 2D splines drawn using emWin.

### 5. Next Steps

- 1 To learn more about the EK-RA6M3G kit, refer to the EK-RA6M3G user’s manual and design package available in the Documents and Download tabs respectively of the EK-RA6M3G webpage at [renesas.com/ra/ek-ra6m3g](https://renesas.com/ra/ek-ra6m3g).
2. Renesas provides several example projects that demonstrate different capabilities of the RA MCUs. These example projects can serve as a good starting point for users to develop custom applications. Example projects (source code and project files) for EK-RA6M3G kit are available in the EK-RA6M3G-Example Projects Bundle. The example projects bundle is available in the Downloads tab of EK-RA6M3G webpage.
  - Download and extract the example projects bundle (xxxxxxxxxxxxxxxx-ek-ra6m3g-exampleprojects.zip) to a local directory on the host PC.
  - Refer to the list of all example projects (xxxxxxxxxxxxxxxx-ek-ra6m3g-exampleprojects.pdf) available inside the example projects bundle.
  - Browse to the desired example project (for example: adc\_ek\_ra6m3g\_ep) in the example projects bundle (xxxxxxxxxxxxxxxx-ek-ra6m3g-exampleprojects\ek\_ra6m3g\adc\adc\_ek\_ra6m3g\_ep)
  - For help on using example projects, refer to Example Project Usage Guide.pdf in the RA Example Repository on GitHub at [github.com/renesas/ra-fsp-examples/tree/master/example\\_projects](https://github.com/renesas/ra-fsp-examples/tree/master/example_projects). The archived versions of the source code of the example projects are available the example project repository.

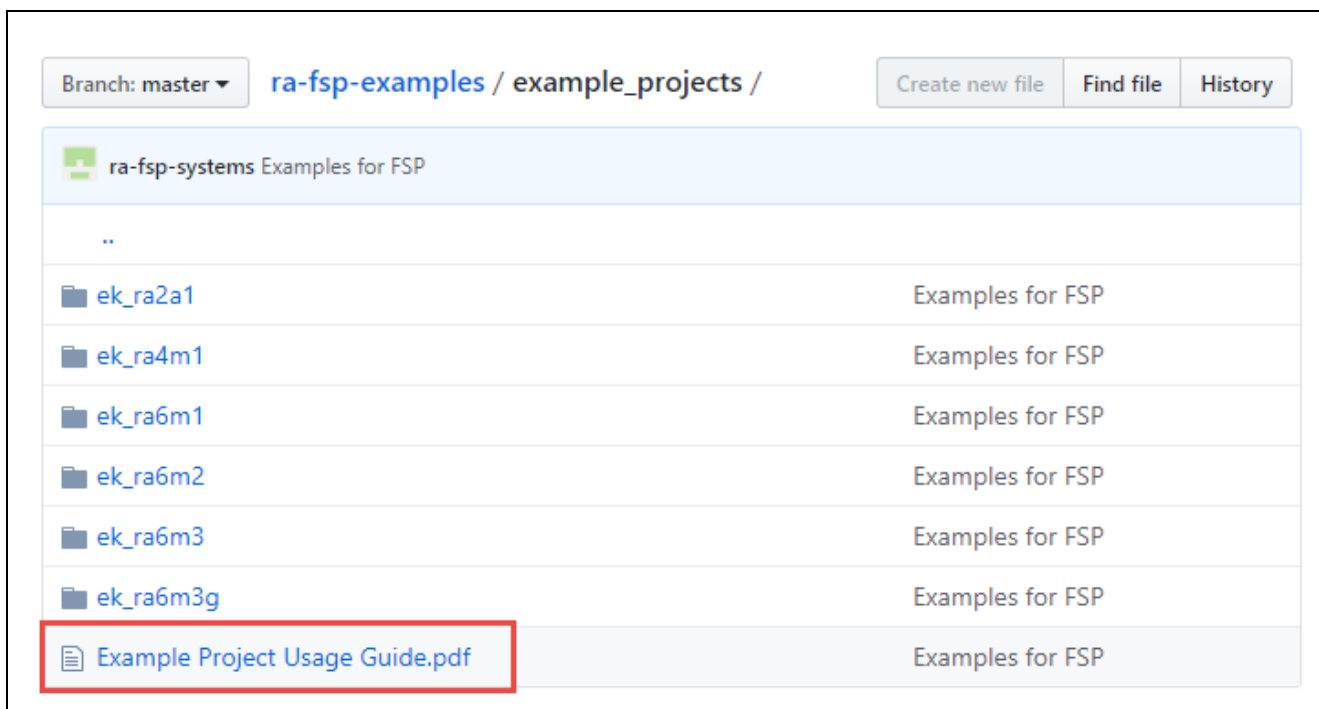
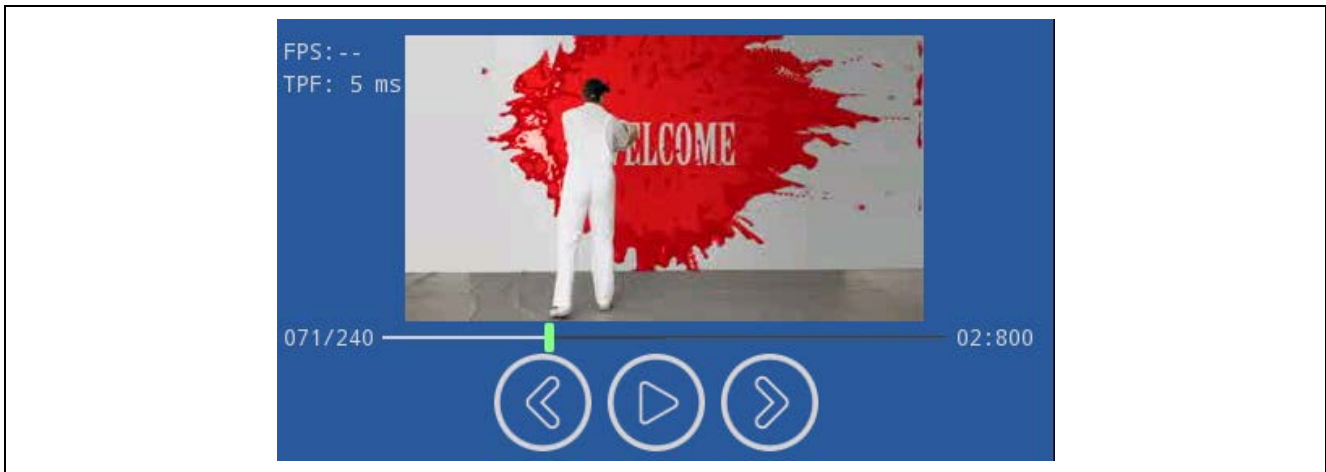

Figure 25. Example Project Directory Contents

3. The source code of the Quick Start example project is provided by SEGGER at [segger.com/renesas-ek-ra6m3g/](https://segger.com/renesas-ek-ra6m3g/). A few additional demo binary files are also provided by SEGGER, some of which are briefly described as follows.

**Movie Demo** displays an emWin Movie File (EMF) using the JPEG decoder to decode individual images of the movie file. The decoded images are drawn with the drawing engine (Dave2D). The values in the top left corner indicate the Frames Per Second (FPS) and the time required to decode and draw a single image. The movie files’ desired FPS is 25.



**Figure 9. Movie Demo**

**Weather Forecast Demo** displays a more sophisticated Weather Forecast example than the one from the Quick Start example. The images are drawn with drawing engine Dave2D.



**Figure 10. Weather Forecast Demo**

4. To learn how to create a new e<sup>2</sup> studio project from scratch, refer to *Chapter 2 Starting Development* in the FSP User Manual ([renesas.com/ra/fsp](https://renesas.com/ra/fsp)). To learn how to use e<sup>2</sup> studio, refer to the User Manual provided on the e<sup>2</sup> studio webpage ([renesas.com/software-tool/e-studio](https://renesas.com/software-tool/e-studio)).

## 6. Website and Support

Visit the following URLs to learn about the kit and the RA family of microcontrollers, download tools and documentation, and get support.

EK-RA6M3G Resources	<a href="https://renesas.com/ra/ek-ra6m3g">renesas.com/ra/ek-ra6m3g</a>
RA Product Information	<a href="https://renesas.com/ra">renesas.com/ra</a>
RA Product Support Forum	<a href="https://renesas.com/ra/forum">renesas.com/ra/forum</a>
Renesas Support	<a href="https://renesas.com/support">renesas.com/support</a>

### Provide Feedback/ Request a Feature

Renesas aims to provide the best microcontroller kit experience to help jumpstart customer innovation with RA family of microcontrollers and take products to market faster. The Renesas RA microcontroller kits have been designed with a lot of attention-to-detail and customer-centric thinking at every aspect of design. Renesas aims to exceed customer expectations.

Renesas looks forward to hearing your feedback and knowing how we can enhance your experience. Please share your feedback at [renesas.com/ra/kitfeedback](https://renesas.com/ra/kitfeedback).

**Revision History**

Rev.	Date	Description	
		Page	Summary
1.00	Oct.16.19	—	Initial release
1.01	Nov.18.19	—	Updated section 5, Next Steps.
1.02	Jun.12.20	10	Updated Example Project information
1.03	Oct.13.21	11, 12	Added step 4 to section 5, Next Steps and the <b>Provide Feedback/ Request a Feature</b> information to section 6, Website and Support.

---

EK-RA6M3G – Quick Start Guide

Publication Date: Oct.13.21

Published by: Renesas Electronics Corporation

---