

RTKA211630DE0010BU

The RTKA211630DE0010BU board evaluates the [RAA211630](#) (HTSSOP version), a DC/DC synchronous step-down regulator with programmable switching frequency.

The RAA211630 supports a wide input voltage range (from 4.5V to 60V) and adjustable output voltage. It delivers up to continuous 3A output current with premium load regulation and line regulation performance.

Features

- Simple and flexible design
- 4.5V to 60V VIN range
- Convenient power conversion

Specifications

The following are the design specifications for the RTKA211630DE0010BU:

- Input voltage (VIN): 4.5V to 60V
- Output voltage (VOUT): 3.3V
- Maximum output current: 3A

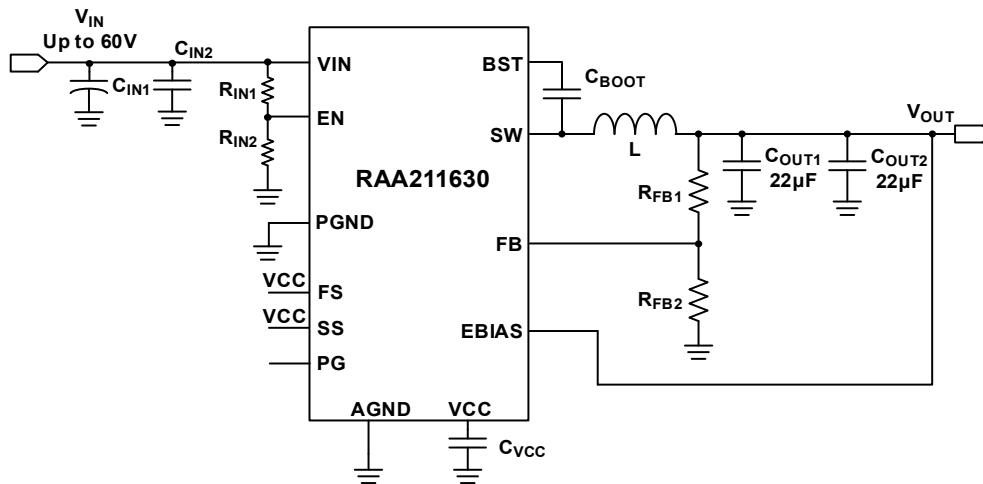

Figure 1. Block Diagram

Contents

1. Functional Description	3
1.1 Operational Characteristics	3
1.2 Setup and Configuration	3
2. Board Design	4
2.1 Layout Guidelines	4
2.2 Schematic Diagram	5
2.3 Bill of Materials	6
2.4 Board Layout	7
4. Ordering Information	10
5. Revision History	10

1. Functional Description

The RAA211630 (HTSSOP version) is an easy-to-use synchronous Buck switching regulator with integrated 145mΩ (high-side) and 45mΩ (low-side) MOSFETs. The RTKA211630DE0010BU board demonstrates the operations of RAA211630. The board allows you to evaluate the performance of the part with different application circuits, and it also provides you a reference for board layout.

The schematic is shown in Figure 4 and PCB layers for reference in Figure 5 through Figure 8. Figure 9 through Figure 16 show performance data and waveforms take from the evaluation board. See Bill of Materials (BOM) for the full list of materials used.

1.1 Operational Characteristics

The board input voltage range is from 4.5V to 60V. The output voltage is set to 3.3V by default and can be changed by R₉ and R₁₀, as shown in Equation 1:

$$(EQ. 1) \quad R_9 = R_{10} \times \frac{V_{out} - 0.8}{0.8}$$

Renesas recommends using a 20kΩ resistor for R₁₀ and choose R₉ based on Equation 1.

1.2 Setup and Configuration

1. Populate a jumper on JP1(VIN shorted to EN).
2. Connect the power supply to the input terminals VIN(T1) and GND(T2). Connect the load to the output terminals VOUT(T3) and GND(T4). Make sure the setup is correctly connected before applying any power or load to the board.
3. Turn on the power supply and the part should start operating.
4. Verify that the output voltage is 3.3V and phase node waveforms can be monitored at J1.

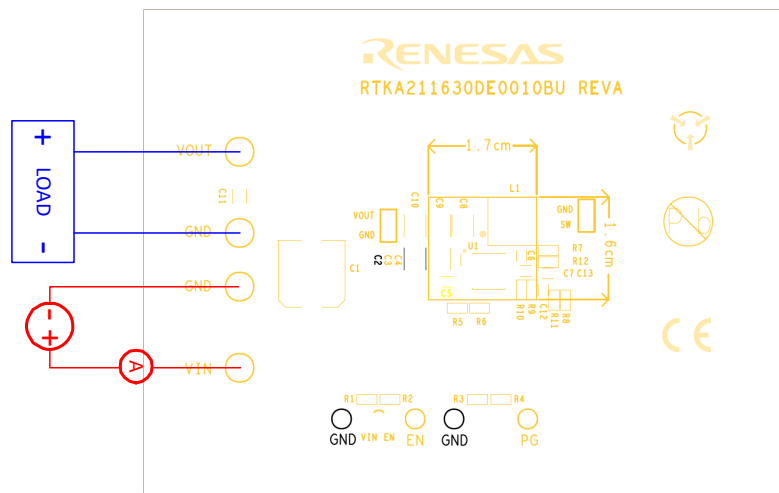

Figure 2. RTKA211630DE0010BU Board Setup

2. Board Design

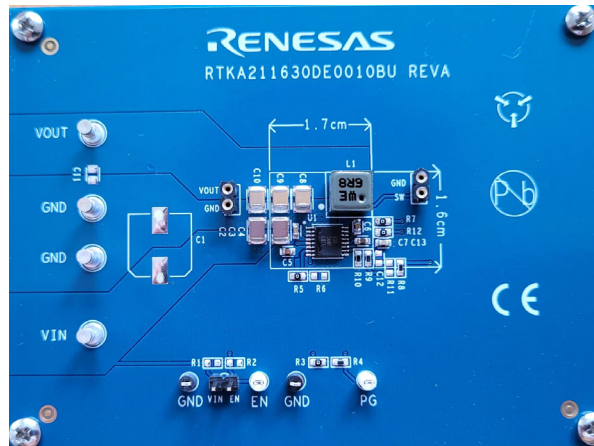

Figure 3. RTKA211630DE0010BU Evaluation Board (Top)

2.1 Layout Guidelines

For detailed layout guidelines reference the Layout Guidelines section in the *RAA211630 Datasheet*.

2.2 Schematic Diagram

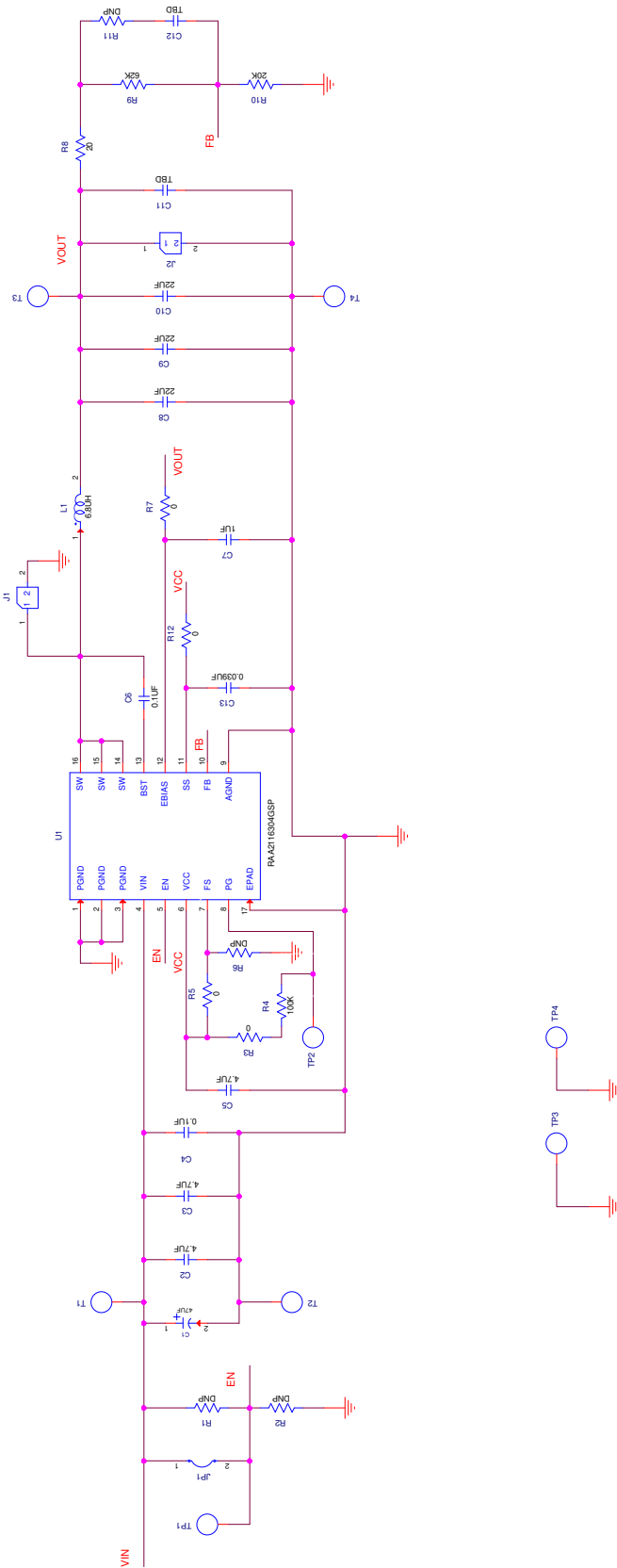

Figure 4. Schematic

2.3 Bill of Materials

Qty	Ref Des	Description	Manufacturer	Part Number
1	C13	CAP, SMD, 0603, 39000pF, 25V, 10%, X7R, ROHS	Panasonic	ECJ-1VB1E393K
3	C8, C9, C10	CAP, SMD, 1210, 22 μ F, 16V, 10%, X7R, ROHS	Murata	GRM32ER71C226KE18L
1	C7	CAP, SMD, 0603, 1.0 μ F, 16V, 10%, X7R, ROHS	TDK	C1608X7R1C105K
1	C6	CAP, SMD, 0603, 0.1 μ F, 16V, 10%, X7R, ROHS	Murata	GCM188R71C104KA37D
1	C5	CAP, SMD, 0603, 4.7 μ F, 10V, 10%, X7S, ROHS	Murata	GRM188C71A475KE11D
1	C4	CAP, SMD, 0603, 0.1 μ F, 100V, 10%, X7R, ROHS	Murata	GRM188R72A104KA35J
2	C2, C3	CAP, SMD, 1210, 4.7 μ F, 100V, 10%, X7R, ROHS	TDK	CNA6P1X7R2A475K250AE
1	L1	COIL-PWR INDUCTOR, SMD, 6.6mmx6.4mm, 6.8uH, 20%, 6.5A, ROHS	Wurth Electronics	74439346068
4	T1, T2, T3, T4	CONN-DBL TURRET, TH, 0.218x0.078 PCB MNT, TIN/BRASS, ROHS	Keystone	1502-1
2	J1, J2	CONN-BRD-BRD, 1x2, TH, SOCKET, 1X64 STRIP, 2.54mm, ST	Mill-max	310-43-164-41-001000
1	TP3, TP4	CONN-MINI TEST PT, VERTICAL, BLK, ROHS	Keystone	5001
1	TP1, TP2	CONN-MINI TEST POINT, VERTICAL, WHITE, ROHS	Keystone	5002
1	JP1	CONN-HEADER, 1x2, RETENTIVE, 2.54mm, 0.230X 0.120, ROHS	BERG/FCI	69190-202HLF
1	R10	RES, SMD, 0603, 20k Ω , 1/10W, 1%, ROHS	Various	Generic
1	R9	RES, SMD, 0603, 62k Ω , 1/10W, 1%, ROHS	Panasonic	ERJ-3EKF6202V
1	R8	RES, SMD, 0603, 20 Ω , 1/10W, 1%, ROHS	Panasonic	ERJ-3EKF20R0V
4	R3, R5, R7, R12	RES, SMD, 0603, 0 Ω , 1/10W, ROHS	Various	VARIOUS
1	R4	RES, SMD, 0603, 100k Ω , 1/10W, 1%, ROHS	Various	VARIOUS
1	U1	IC-60V, 3A SWITCHING REGULATOR, 16P, HTSSOP, ROHS	Renesas	RAA211630GSP
0	C1	CAP, SMD, 12x10, 47 μ F, 100V, 20%, ALUM.ELEC., ROHS	Vishay	MAL214699904E3
0	C11, C12, R1, R2, R6, R11	DO NOT POPULATE	N/A	N/A

2.4 Board Layout

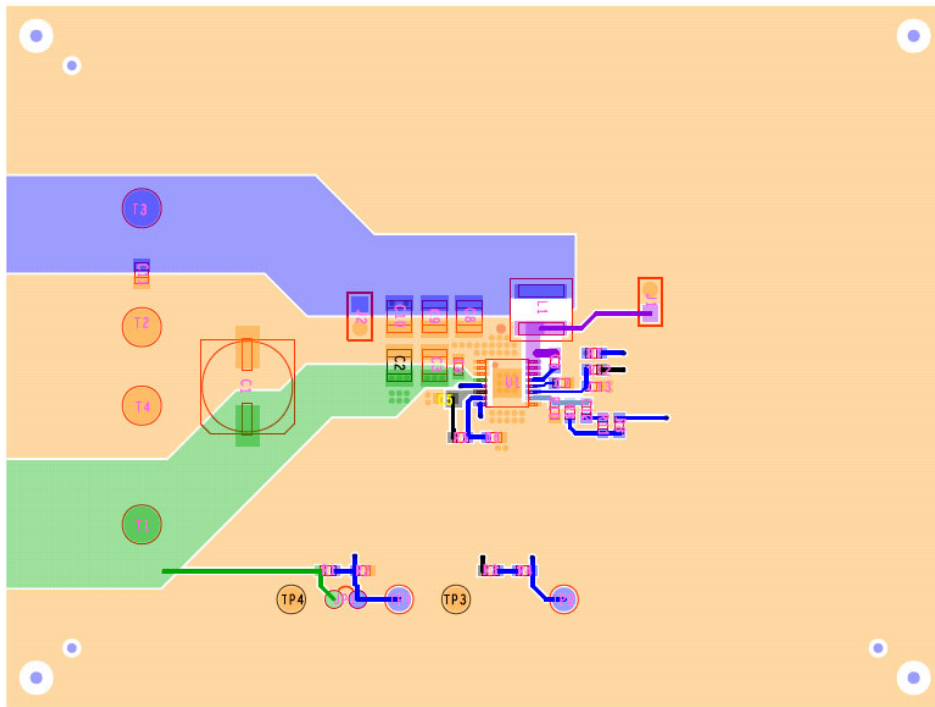

Figure 5. Top Layer

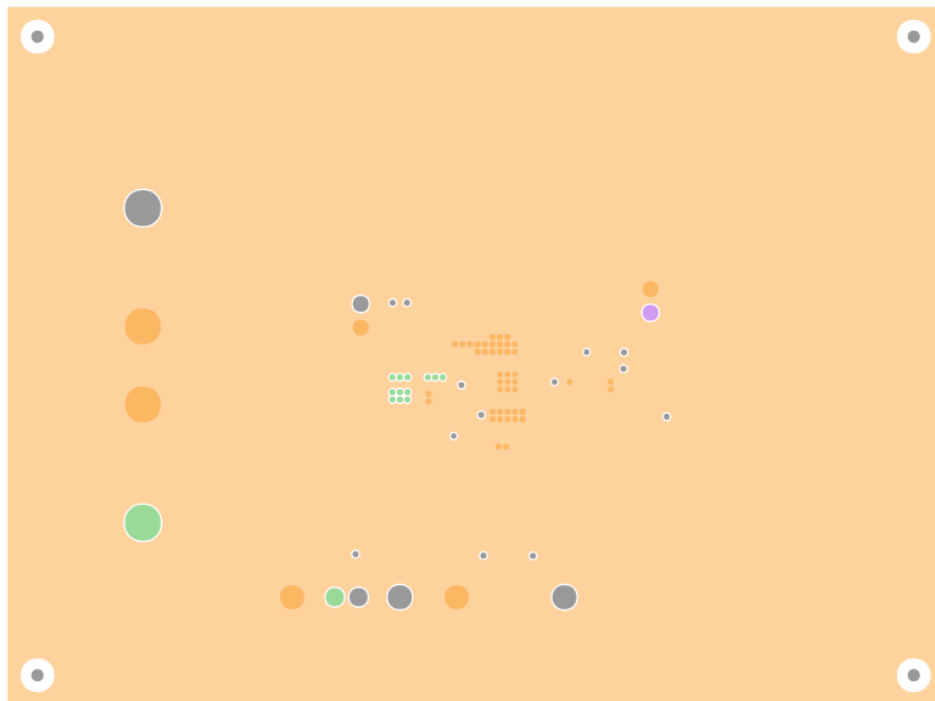

Figure 6. Second Layer

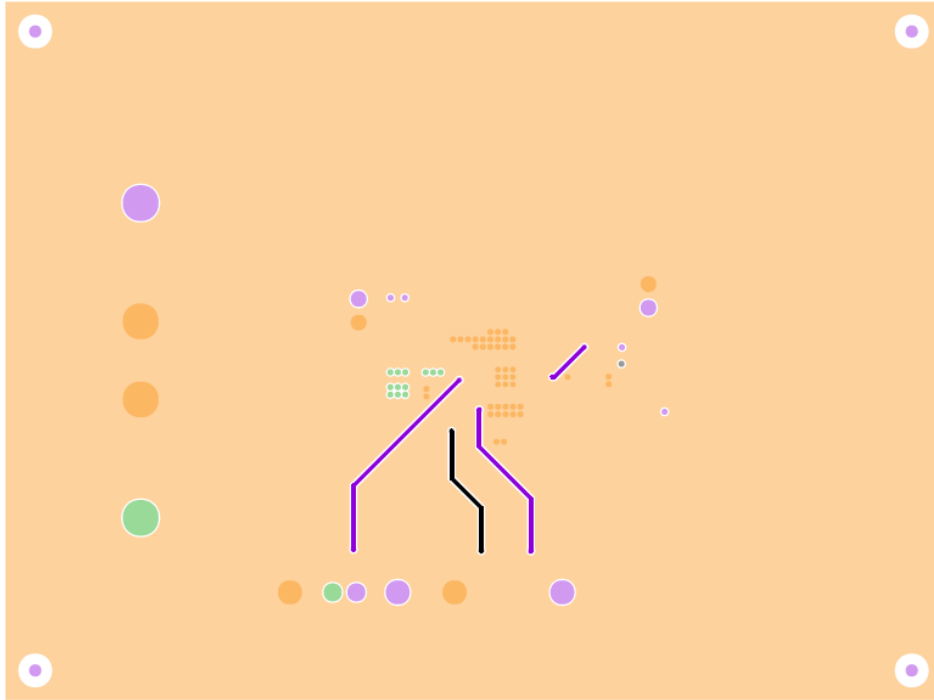

Figure 7. Third Layer

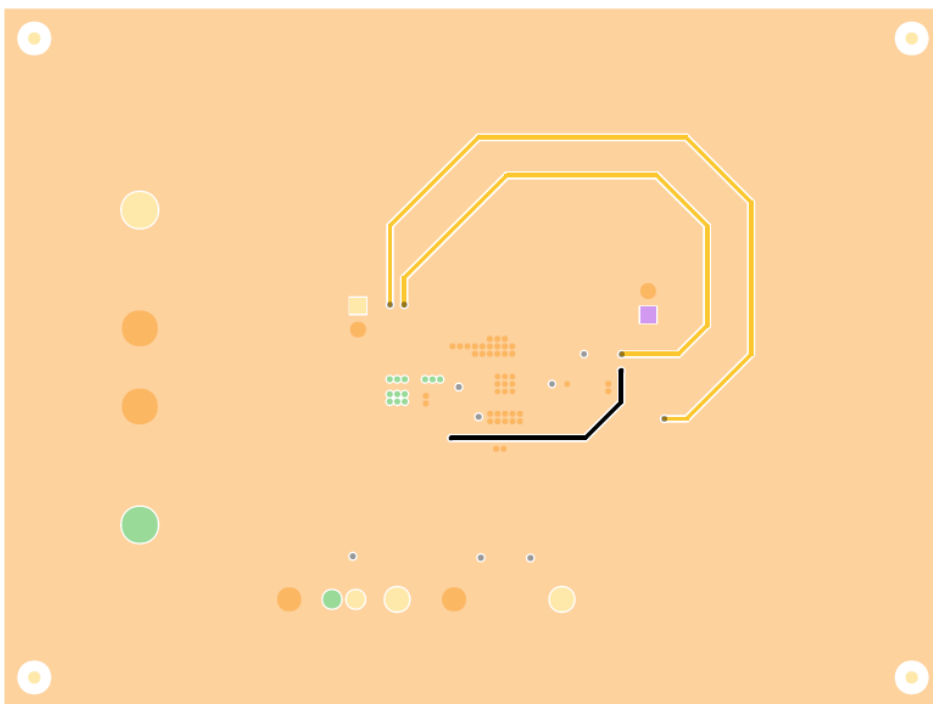

Figure 8. Bottom Layer

3. Typical Performance Curves

$V_{IN} = 24V$, $V_{OUT} = 3.3V$, $T_A = +25^{\circ}C$, unless otherwise noted.

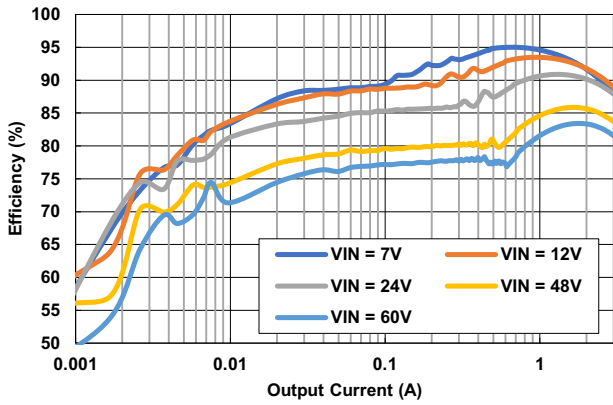

Figure 9. Efficiency vs Load

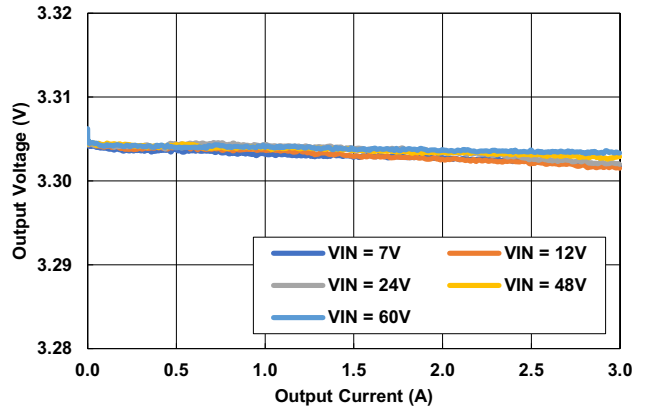

Figure 10. Load Regulation

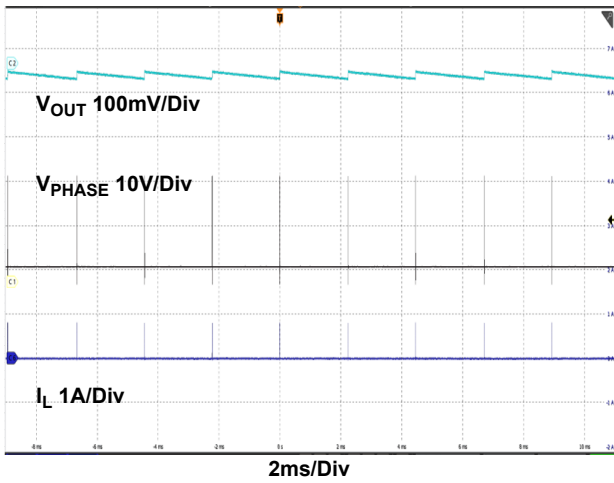

Figure 11. Output Ripple at No Load

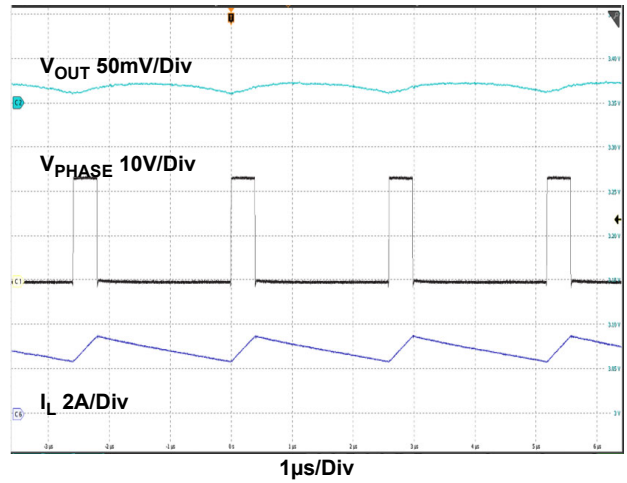

Figure 12. Output Ripple at Full Load

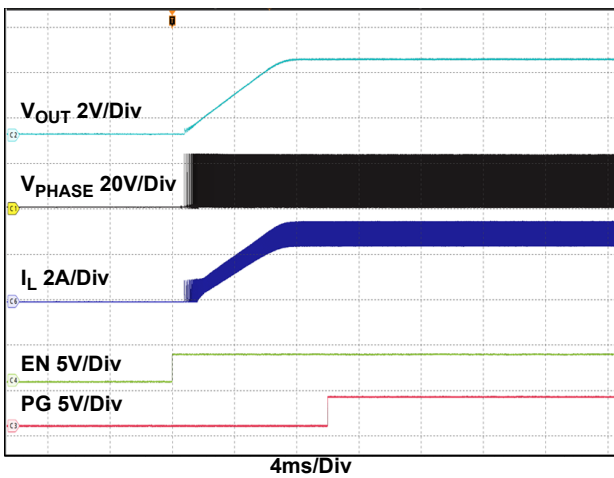

Figure 13. Enable On at Full Load with External SS

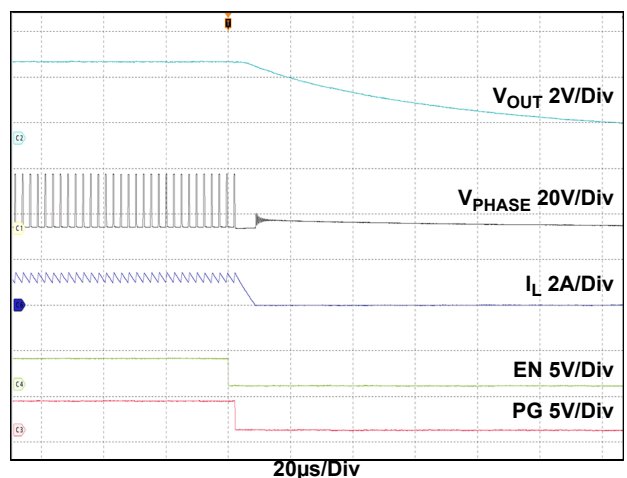

Figure 14. Enable Off at Full Load with External SS

$V_{IN} = 24V$, $V_{OUT} = 3.3V$, $T_A = +25^{\circ}C$, unless otherwise noted. (Cont.)

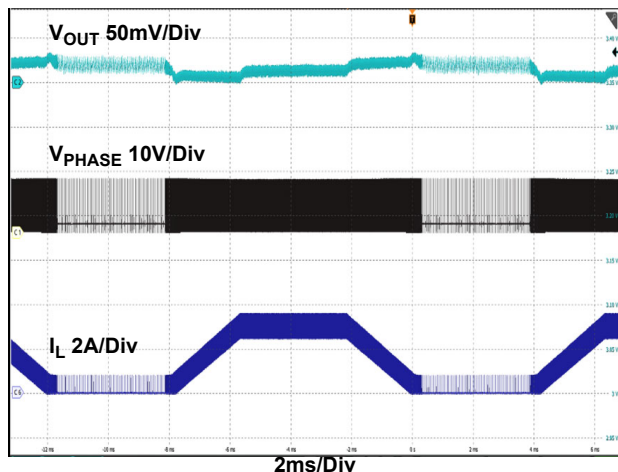

Figure 15. Load Ramp from 0A to 3A

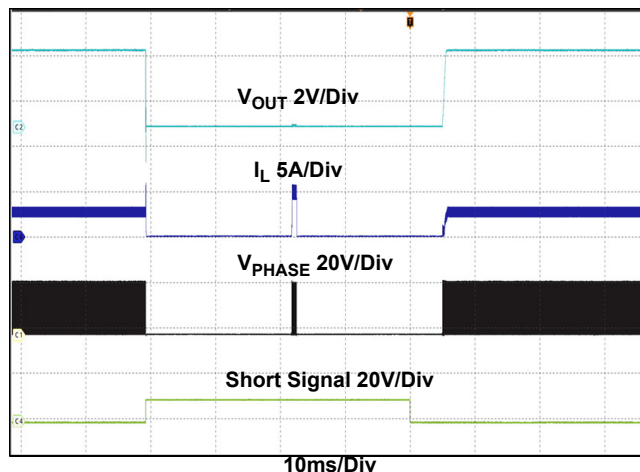

Figure 16. Short V_{OUT} and Recovery at Full load (Hiccup)

4. Ordering Information

Part Number	Description
RTKA211630DE0010BU	RAA211630 (HTSSOP Version) Evaluation Board

5. Revision History

Revision	Date	Description
1.01	Apr 27, 2022	Minor update to Figure 1.
1.00	Apr 20, 2022	Initial release