

RUTXR1

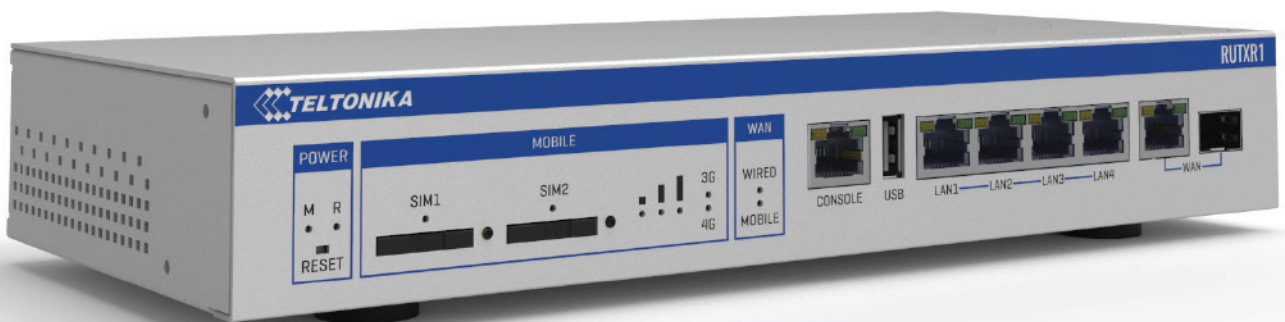

HARDWARE

FRONT VIEW

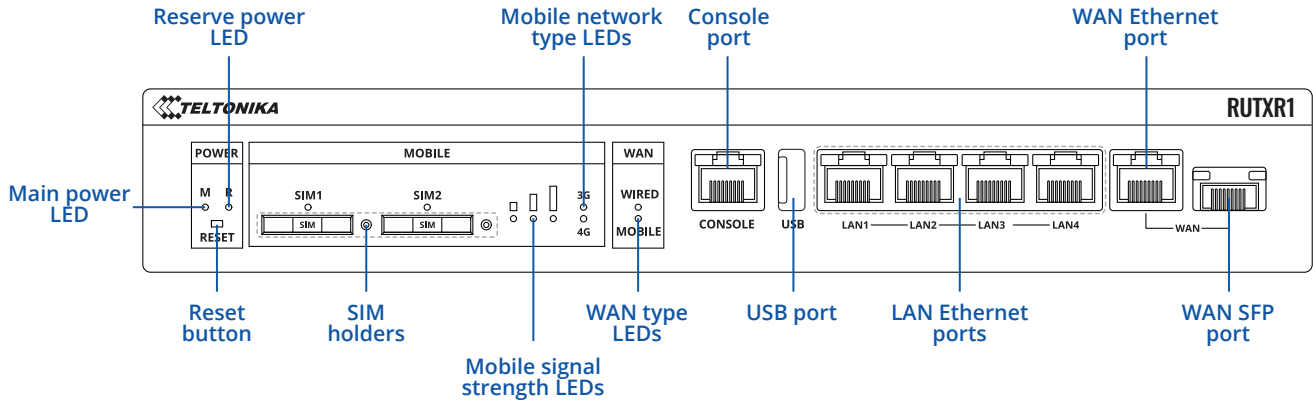

BACK VIEW

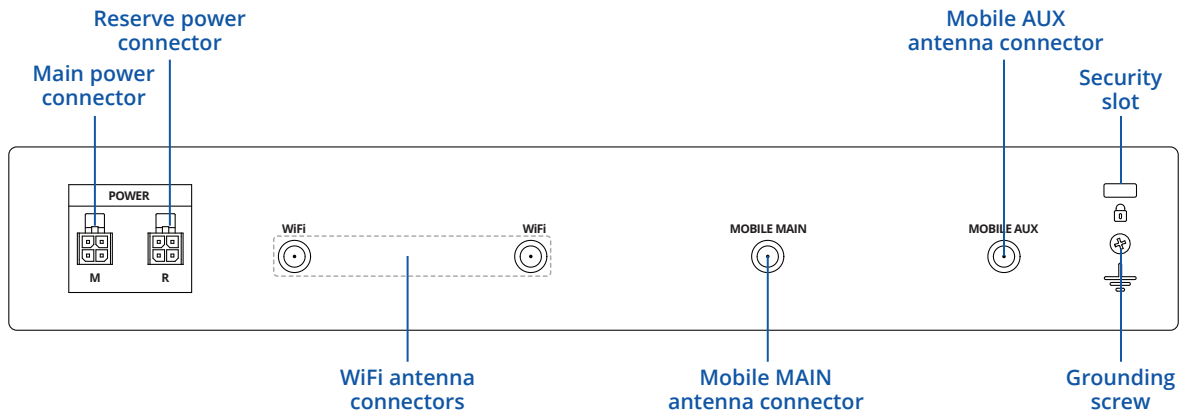

POWER SOCKET PINOUT

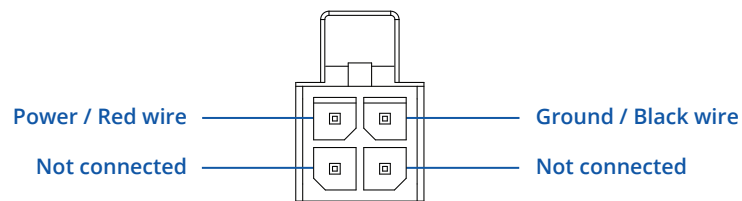

FEATURES

MOBILE

Mobile module	4G (LTE) – Cat 6 up to 300 Mbps, 3G – up to 42 Mbps
SIM switch	2 SIM cards, auto switch cases: weak signal, data limit, SMS limit, roaming, no network, network denied, data connection fail
Status	Signal strength, SINR, RSRP, RSRQ, Bytes sent/received, connected band, carrier aggregation, IMSI, ICCID
SMS	SMS status, SMS configuration, send/read SMS via HTTP POST/GET, Email to SMS, SMS to Email, SMS to HTTP, SMS to SMS, SMS auto replay
USSD	Supports sending and reading Unstructured Supplementary Service Data messages
Black/White list	Operator black/white list
Multiple PDN	Possibility to use different PDNs for multiple network access and services
Band management	Band lock, Used band status display
APN	Auto APN
Bridge mode	Direct connection (bridge) between mobile ISP and device on LAN

WIRELESS

Wireless mode	802.11b/g/n/ac Wave 2 (WiFi 5) with data transmission rates up to 867 Mbps (Dual Band, MU-MIMO), 802.11r fast transition, Access Point (AP), Station (STA)
WiFi security	WPA3-EAP, WPA3-SAE, WPA2-Enterprise-PEAP, WPA2-PSK, WEP; AES-CCMP, TKIP, Auto Cipher modes, client separation
ESSID	ESSID stealth mode
WiFi users	up to 150 simultaneous connections
Wireless Hotspot	Captive portal (Hotspot), internal/external Radius server, built in customizable landing page

ETHERNET

WAN	1 x WAN port 10/100/1000 Mbps, compliance with IEEE 802.3, IEEE 802.3u, 802.3az standards, supports auto MDI/MDIX crossover
Fiber	1 x SFP port (cannot work simultaneously with Ethernet WAN port)
LAN	4 x LAN ports, 10/100/1000 Mbps, compliance with IEEE 802.3, IEEE 802.3u, 802.3az standards, supports auto MDI/MDIX crossover

CONSOLE

Console	RS-232 (RJ45) console port for router configuration and debugging
---------	---

NETWORK

Routing	Static routing, Dynamic routing (BGP, OSPF v2, RIP v1/v2, EIGRP, NHRP)
Network protocols	TCP, UDP, IPv4, IPv6, ICMP, NTP, DNS, HTTP, HTTPS, FTP, SMTP, SSL v3, TLS, ARP, VRRP, PPP, UPNP, SSH, DHCP, Telnet, SNMP, MQTT, Wake on LAN (WOL), DLNA
VoIP passthrough support	H.323 and SIP-alg protocol NAT helpers, allowing proper routing of VoIP packets
Connection monitoring	Ping Reboot, Wget reboot, Periodic Reboot, LCP and ICMP for link inspection
Firewall	Port forwards, traffic rules, custom rules
DHCP	Static and dynamic IP allocation, DHCP Relay, Relayd
QoS / Smart Queue Management (SQM)	Traffic priority queuing by source/destination, service, protocol or port, WMM, 802.11e
DDNS	Supported >25 service providers, others can be configured manually
Network backup	VRRP, Mobile, Wired, Fiber and WiFi WAN options, each of which can be used as an automatic Failover
Load balancing	Balance Internet traffic over multiple WAN connections
SSHFS	Possibility to mount remote file system via SSH protocol

SECURITY

Authentication	Pre-shared key, digital certificates, X.509 certificates
Firewall	Pre-configured firewall rules can be enabled via WebUI, unlimited firewall configuration via CLI; DMZ; NAT; NAT-T
Attack prevention	DDOS prevention (SYN flood protection, SSH attack prevention, HTTP/HTTPS attack prevention), port scan prevention (SYN-FIN, SYN-RST, X-mas, NULL flags, FIN scan attacks)
VLAN	Port and tag based VLAN separation
Mobile quota control	Custom data limits for both SIM cards
WEB filter	Blacklist for blocking out unwanted websites, Whitelist for specifying allowed sites only
Access control	Flexible access control of TCP, UDP, ICMP packets, MAC address filter

VPN

OpenVPN	Multiple clients and a server can run simultaneously, 12 encryption methods
OpenVPN Encryption	DES-CBC, RC2-CBC, DES-EDE-CBC, DES-EDE3-CBC, DESX-CBC, BF-CBC, RC2-40-CBC, CAST5-CBC, RC2-64-CBC, AES-128-CBC, AES-192-CBC, AES-256-CBC
IPsec	IKEv1, IKEv2, with 5 encryption methods for IPsec (DES, 3DES, AES128, AES192, AES256)
GRE	GRE tunnel
PPTP, L2TP	Client/Server instances can run simultaneously, L2TPv3 support
Stunnel	Proxy designed to add TLS encryption functionality to existing clients and servers without any changes in the program's code
DMVPN	Method of building scalable IPsec VPNs
SSTP	SSTP client instance support
Zerotier	Zerotier VPN client support
WireGuard	WireGuard VPN client and server support

MODBUS TCP SLAVE

ID filtering	Respond to one ID in range [1;255] or any
Allow remote access	Allow access through WAN
Custom registers	Modbus TCP custom register block, which allows to read/write to a file inside the router, and can be used to extend Modbus TCP slave functionality

MODBUS TCP MASTER

Supported functions	01, 02, 03, 04, 05, 06, 15, 16
Supported data formats	8 bit: INT, UINT; 16 bit: INT, UINT (MSB or LSB first); 32 bit: float, INT, UINT (ABCD (big-endian), DCBA (little-endian), CDAB, BADC)

MODBUS RTU MASTER (RS232) (PLANNED)

Supported baud rates	From 300 to 115200
Supported functions	01, 02, 03, 04, 05 (only for alarms), 06 (only for alarms), 15 (only for alarms), 16 (only for alarms)
Number of data bits	From 5 to 8
Number of stop bits	1 or 2
Parity	None, Even, Odd
Flow	None, RTS/CTS, Xon/Xoff

MQTT GATEWAY

Gateways	Allows sending commands and receiving data from Modbus Master through MQTT broker
----------	---

DATA TO SERVER

Protocols	HTTP(S), MQTT, Azure MQTT, Kinesis
-----------	------------------------------------

MONITORING & MANAGEMENT

WEB UI	HTTP/HTTPS, status, configuration, FW update, CLI, troubleshoot, event log, system log, kernel log
FOTA	Firmware update from server, automatic notification
SSH	SSH (v1, v2)
SMS	SMS status, SMS configuration, send/read SMS via HTTP POST/GET
Call	Reboot, Status, Mobile data on/off, Output on/off
TR-069	OpenACS, EasyCwmp, ACSLite, tGem, LibreACS, GenieACS, FreeACS, LibCWMP, Friendly tech, AVSystem
MQTT	MQTT Broker, MQTT publisher
SNMP	SNMP (v1, v2, v3), SNMP Trap
JSON-RPC	Management API over HTTP/HTTPS
MODBUS	MODBUS TCP status/control

IOT PLATFORMS

Clouds of things	Allows monitoring of: Device data, Mobile data, Network info, Availability
ThingWorx	Allows monitoring of: WAN Type, WAN IP Mobile Operator Name, Mobile Signal Strength, Mobile Network Type
Cumulocity	Allows monitoring of: Device Model, Revision and Serial Number, Mobile Cell ID, ICCID, IMEI, Connection Type, Operator, Signal Strength, WAN Type and IP
Azure IoT Hub	Can send device IP, Number of bytes send/received/ 3G connection state, Network link state, IMEI, ICCID, Model, Manufacturer, Serial, Revision, IMSI, Sim State, PIN state, GSM signal, WCDMA RSCP, WCDMA EC/IO, LTE RSRP, LTE SINR, LTE RSRQ, CELL ID, Operator, Operator number, Connection type, Temperature, PIN count to Azure IoT Hub server

SYSTEM CHARACTERISTICS

CPU	Quad-core ARM Cortex A7, 717 MHz
RAM	256 MB, DDR3
FLASH storage	256 MB, SPI Flash

FIRMWARE/CONFIGURATION

WEB UI	Update FW from file, check FW on server, configuration profiles, configuration backup
FOTA	Update FW/configuration from server
RMS	Update FW/configuration for multiple devices at once
Keep settings	Update FW without losing current configuration

FIRMWARE CUSTOMIZATION

Operating system	RutOS (OpenWrt based Linux OS)
Supported languages	Busybox shell, Lua, C, C++
Development tools	SDK package with build environment provided

SERIAL

RS232	RJ45 connector, full RS232 (with RTS, CTS)
Serial functions	Console (active by default), Modbus gateway, Modbus RTU master, Serial OverIP, Modem mode (Full or partial) (planned), Ntrip client

USB

Data rate	USB 2.0
Applications	Samba share, USB-to-serial
External devices	Possibility to connect external HDD, flash drive, additional modem, printer
Storage formats	FAT, FAT32, NTFS

POWER

Connector	2 x 4 pin industrial DC power sockets for main and redundancy power sources
Input voltage range	9 – 50 VDC, reverse polarity protection, voltage surge/transient protection
Power consumption	idle: <3W, max: 18W

PHYSICAL INTERFACES (PORTS, LEDS, ANTENNAS, BUTTONS, SIM)

Ethernet	5 x RJ45 ports, 10/100/1000 Mbps
Console	1 x RJ45, RS232 communication
Fiber	1 x SFP port
Status LEDs	2 x WAN type, 2 x Mobile connection type, 3 x Mobile signal strength, 2 x active SIM, 10 x Ethernet status, 2 x Console status, 2 x Power
SIM	2 x SIM slots (Mini SIM - 2FF), 1.8 V/3 V, external SIM holders
Power	2 x 4 pin DC connector
Antennas	2 x SMA for LTE, 2 x RP-SMA for WiFi
USB	1 x USB A port for external devices
Reset	Reboot/User default reset/Factory reset button
Other	1 x Grounding screw, 1 x lock

PHYSICAL SPECIFICATION

Casing material	Full steel housing
Dimensions (W x H x D)	272 x 42.6 x 122.6 mm
Weight	1050 g
Mounting options	Rack mounting, flat surface placement

OPERATING ENVIRONMENT

Operating temperature	-40°C to +75°C
Operating humidity	10 % to 90 % non-condensing

HARDWARE INSTALLATION

1. Push the SIM holder button with the SIM needle.
2. Pull out the SIM holder.
3. Insert your SIM card into the SIM holder.
4. Slide the SIM holder back into the router.
5. Attach all antennas.
6. Connect the power adapter to the socket on the back of the device. Then plug the other end of the power adapter into a power outlet.
7. Connect to the device wirelessly using SSID and password provided on the device information label or use an Ethernet cable connected to LAN port.

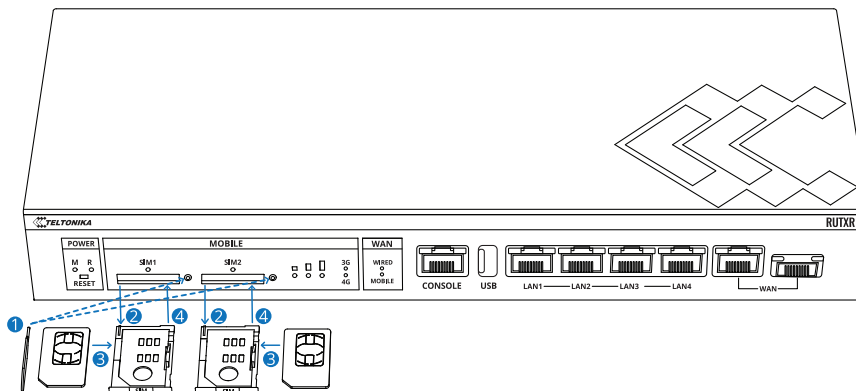

LOGIN TO DEVICE

1. To enter the router's Web interface (WebUI), type <http://192.168.1.1> into the URL field of your Internet browser.
2. Use login information shown in image A when prompted for authentication.
3. After you log in, you will be prompted to change your password for security reasons. The new password must contain at least 8 characters, including at least one uppercase letter, one lowercase letter, and one digit. This step is mandatory, and **you will not be able to interact with the router's WebUI before you change the password.**
4. When you change the router's password, the **Configuration Wizard** will start. The **Configuration Wizard** is a tool used to set up some of the router's main operating parameters.
5. Go to the **Overview** page and pay attention to the **Signal Strength** indication (image B). To maximize the cellular performance try adjusting the antennas or changing the location of your device to achieve the best signal conditions.

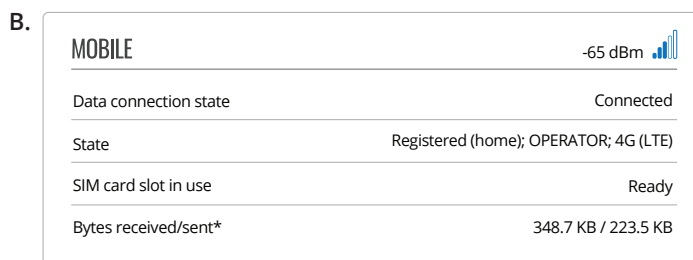
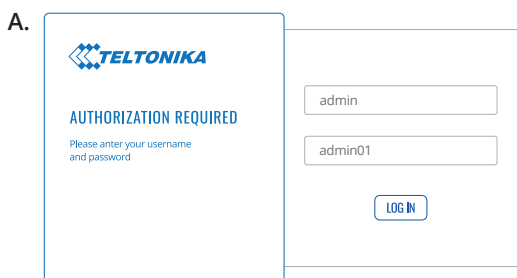

TECHNICAL INFORMATION

Radio specifications	
RF technologies	3G, 4G, WiFi
Max RF power	24 dBm@WCDMA, 23 dBm@LTE, 23 dBm@WiFi
Bundled accessories specifications*	
Power adapter	Input: 0.6 A@100-240 VAC, Output: 12 VDC, 1.5 A, 4-pin plug
Mobile antenna	699 ~ 868 / 1850 ~ 2690 MHz, 50 Ω, VSWR<3, gain** 1 dBi, omnidirectional, SMA male connector
WiFi antenna	2400 ~ 2500 MHz / 4950 ~ 5850 MHz, 50 Ω, VSWR<2, gain** 3 dBi, omnidirectional, RP-SMA male connector

*Order code dependent.









**Higher gain antenna can be connected to compensate for cable attenuation when a cable is used. The user is responsible for the compliance with the legal regulations.

WHAT'S IN THE BOX?

STANDARD PACKAGE CONTAINS*

- RUTXR1
- 18 W PSU
- 2 x LTE antennas (magnetic mount, SMA male, 3 m cable)
- 2 x WiFi antennas (magnetic mount, RP-SMA male, 1.5 m cable)
- Rack - mounting kit
- 4 x Standing pads
- 8 x Screws
- SIM Adapter kit
- Ethernet cable (1.5 m)
- QSG (Quick Start Guide)
- RMS Flyer
- Packaging box



 <p>RUTXR1</p>	 <p>18 W PSU</p>	 <p>2 X LTE ANTENNAS (MAGNETIC MOUNT, SMA MALE, 3 M CABLE)</p>
 <p>2 X WIFI ANTENNAS (MAGNETIC MOUNT, RP-SMA MALE, 1.5 M CABLE)</p>	 <p>RACK - MOUNTING KIT</p>	 <p>4 X STANDING PADS</p>
 <p>8 X SCREWS</p>	 <p>SIM ADAPTER KIT</p>	 <p>ETHERNET CABLE (1.5 M)</p>

* For all standard order codes standard package contents are the same, except for PSU.

STANDARD ORDER CODES

PRODUCT CODE	HS CODE	HTS CODE	PACKAGE CONTAINS
RUTXR1 000000	851762	8517.62.00	Standard package

For more information on all available packaging options – please contact us directly.

AVAILABLE VERSIONS

PRODUCT CODE	REGION (OPERATOR)	FREQUENCY
RUTXR1 0*****	Europe, the Middle East, Africa, Australia, APAC ² , Brazil, Malaysia	<ul style="list-style-type: none"> • 4G (LTE-FDD): B1, B3, B5, B7, B8, B20, B28, B32¹ • 4G (LTE-TDD): B38, B40, B41 • 3G: B1, B3, B5, B8
RUTXR1 1*****	North America	<ul style="list-style-type: none"> • 4G (LTE-FDD): B2, B4, B5, B7, B12, B13, B25, B26, B29¹, B30, B66 • 3G: B2, B4, B5

The price and lead-times for region (operator) specific versions may vary. For more information please contact us.

1 - LTE-FDD B32 Support Rx Only, and in 2xCA it is Only for Secondary Component Carrier.

2 - Excluding Japan and CMCC.

RUTXR1 SPATIAL MEASUREMENTS & WEIGHT

MAIN MEASUREMENTS

W x H x D dimensions for RUTXR1:

Device housing*: 272 x 42.6 x 122.6

Box: 355 x 175 x 60

*Housing measurements are presented without antenna connectors and screws; for measurements of other device elements look to the sections below.

TOP VIEW

The figure below depicts the measurements of RUTXR1 and its components as seen from the top:

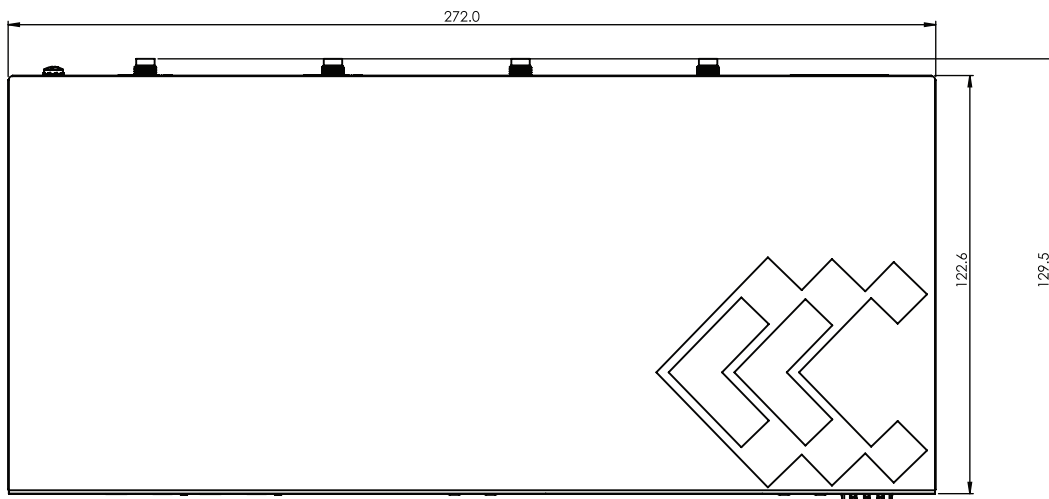

RIGHT VIEW

The figure below depicts the measurements of RUTXR1 and its components as seen from the right side:

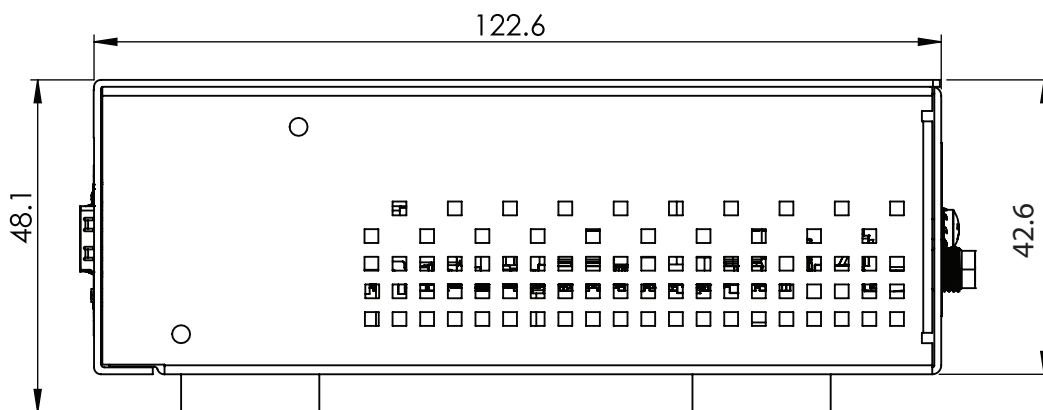

FRONT VIEW

The figure below depicts the measurements of RUTXR1 and its components as seen from the front panel side:

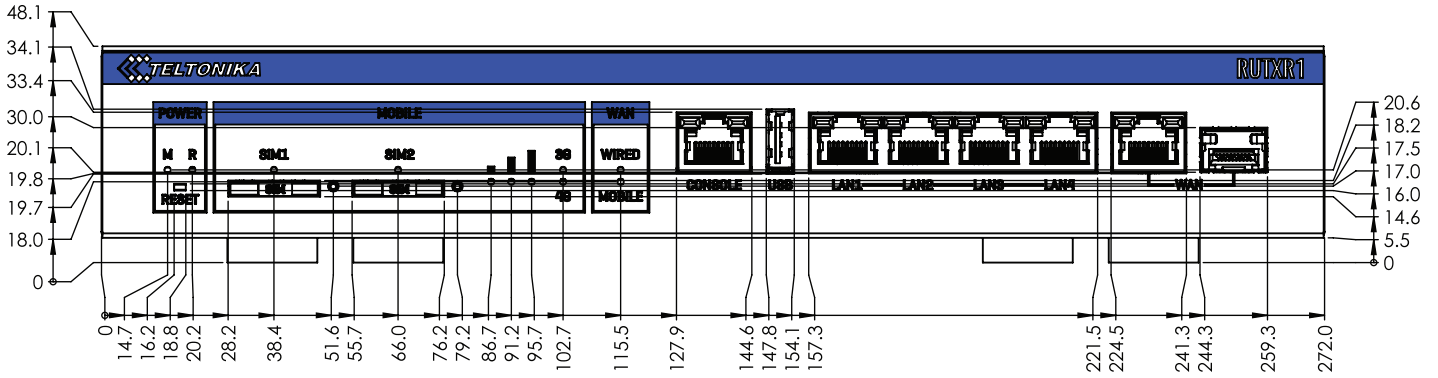

REAR VIEW

The figure below depicts the measurements of RUTXR1 and its components as seen from the back panel side:

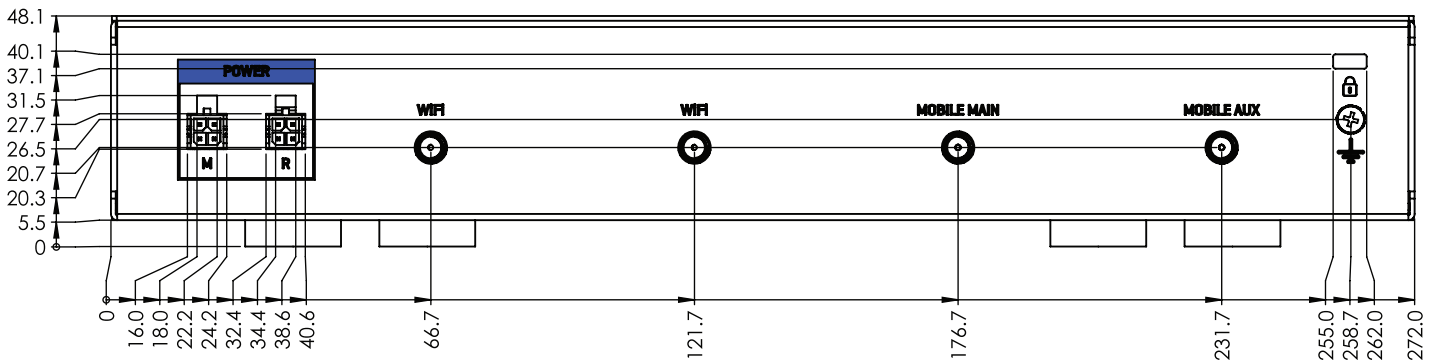

MOUNTING SPACE REQUIREMENTS

The figure below depicts an approximation of the device's dimensions when cables and antennas are attached:

