

Three phase AC pumps and ventilators soft starter



Benefits

- **Easy to use.** The RSWT is equipped with a self-learning algorithm that automatically adjusts the start parameters to optimise the motor starts and stops.
- **Fast installation and set-up.** Only 3 settings are required (FLC, ramp-up and ramp-down).
- **Compact dimensions.** 12 - 25 Arms in 45 mm wide housing, 32 - 55 Arms in 75 mm wide housing, 70 - 90 Arms in 120 mm wide housing.
- **Integrated protection.** Diagnostic functions provide additional protection. RSWT is also equipped with an overload protection (Class 10).
- **Three phase controlled.**
- **Guided model selection.** Easy to use selection tool to select the appropriate soft starter model depending on the application type.

Description

RSWT is an extremely compact and easy to use 3-phase soft starter for AC pumps and ventilators rated up to 90 Arms.

The starting parameters can be easily set-up through 3 knobs.

The integrated motor overload protection (Class 10) results in a higher installation flexibility.

Applications

RSWT soft starters are the ideal solution for 3-phase fixed speed AC pumps and ventilators where there is the need to reduce the starting current and/or minimise stresses on the motor during start and stop.

The RSWT offers a number of integrated diagnostic functions that can replace additional components inside the electrical panel.

Typical applications include: pumps and fans.

Main functions

- Soft starting and soft stopping of pumps and ventilators.
- Integrated electronic overload protection (Class 10).

References

 **Order code**

 **RSW T** **V 1**

Enter the code entering the corresponding option instead of

Code	Option	Description	Notes
R	-		
S	-	Soft starter	
W	-	Pump and ventilator	
T	-	3 phase	
<input type="checkbox"/>	40	220 – 400 VAC +10% -15% operational voltage (Ue)	
	60	220 – 600 VAC +10% -15% operational voltage (Ue)	
<input type="checkbox"/>	12	12 Arms	Rated operational current @ 40°C
	16	16 Arms	
	25	25 Arms	
	32	32 Arms	
	37	37 Arms	
	45	45 Arms	
	55	55 Arms	
	70	70 Arms	
<input type="checkbox"/>	E0	110 - 400 VAC +10% -15% control voltage (Uc) Supply voltage: internally supplied	
	F0	24 VAC/DC +10% -10% control voltage (Uc) Supply voltage: internally supplied	
	FF	24 VAC/DC +10% -10% control/supply voltage Supply voltage: externally supplied	
	GG	100 - 240 VAC +10% -15% control/supply voltage Supply voltage: externally supplied	
V	-		
1	-	With integrated motor overload protection (Class 10)	
<input type="checkbox"/>	1	With PTC	
	0	No PTC	
<input type="checkbox"/>	1	With fan	RSWT 75 mm, RSWT 120 mm only.
	0	No fan	

Selection guide

Rated operational current (I _e)	Operational voltage: 400 VAC		Operational voltage: 600 VAC	
	Control voltage 110 - 400 VAC	Control voltage 24 VAC/DC	Control/supply voltage 100 - 240 VAC	Control/supply voltage 24 VAC/DC
12 Arms	RSWT4012E0V10	RSWT4012F0V10	RSWT6012GGV10	RSWT6012FFV10
16 Arms	RSWT4016E0V10	RSWT4016F0V10	RSWT6016GGV10	RSWT6016FFV10
25 Arms	RSWT4025E0V10	RSWT4025F0V10	RSWT6025GGV10	RSWT6025FFV10
32 Arms	RSWT4032E0V110	RSWT4032F0V110	RSWT6032GGV110	RSWT6032FFV110
37 Arms	RSWT4037E0V110	RSWT4037F0V110	RSWT6037GGV110	RSWT6037FFV110
45 Arms	RSWT4045E0V111	RSWT4045F0V111	RSWT6045GGV111	RSWT6045FFV111
55 Arms	RSWT4055E0V111	RSWT4055F0V111	RSWT6055GGV111	RSWT6055FFV111
70 Arms	RSWT4070E0V111	RSWT4070F0V111	RSWT6070GGV111	RSWT6070FFV111
90 Arms	RSWT4090E0V111	RSWT4090F0V111	RSWT6090GGV111	RSWT6090FFV111

Further reading

Information	Where to find it
RSWT 45 mm instruction manual	http://www.productselection.net/MANUALS/UK/mc_il_rswt_il.pdf
RSWT 75 mm/RSWT 120 mm instruction manual	http://www.productselection.net/MANUALS/UK/mc_il_rswt_75_il.pdf
RSWT Troubleshooting guide	http://www.gavazziautomation.com/document/manual/mc_RSWT_qsg.pdf
CAD drawings (RSWT 45 mm)	http://www.productselection.net/DXF/MC_RSWT45_12_16.zip http://www.productselection.net/DXF/MC_RSWT45_25.zip
CAD drawings (RSWT 75 mm)	http://www.productselection.net/DXF/MC_RSWT_75mm_NO_FAN.zip http://www.productselection.net/DXF/MC_RSWT_75mm_WITH_FAN.zip
CAD drawings (RSWT 120 mm)	http://www.productselection.net/DXF/MC_RSWT_120mm.zip

Selection guide and typical application settings

Category	Type	Trip Class	Ramp-up setting [s]	Ramp-down setting [s]	FLC setting [Arms]
Pumps	Waste water pump	10	2 to 5	0	1.2 x Motor FLC
	Centrifugal pump	10	5 to 10	5 to 10	1 x Motor FLC
	Vacuum pump	10	2 to 5	0	1 x Motor FLC
Fans	Centrifugal fan (<0.5 m diameter)	10	5 to 10	0	1 x Motor FLC
	Centrifugal fan (>0.5 m diameter)	20	10 to 20	0	1.2 x Motor FLC
	Vacuum blowers	10	5 to 10	0	1 x Motor FLC

Note: For Trip class 20 applications we recommend the use of an external overload protection due to the higher FLC setting that is required on RSWT. The FLC setting for Class 20 applications needs to be set to a higher value with respect to the motor FLC in order not to trip the electronic motor overload protection available on the RSWT soft starters.

Motor FLC [A]	HP Rating @ 230 V	Power kW @ 400 V	Trip class 5	Trip class 10	Trip class 20
3.4	0.75	1.5	RSWT4012...	RSWT4012...	RSWT4012...
5	1	2.2	RSWT4012...	RSWT4012...	RSWT4012...
6	1.5	3.0	RSWT4012...	RSWT4012...	RSWT4012...
9	2	3.7	RSWT4012...	RSWT4012...	RSWT4025...
12	3	5.5	RSWT4012...	RSWT4012...	RSWT4032...
16	5	7.5	RSWT4016...	RSWT4016...	RSWT4032...
22	7.5	11	RSWT4025...	RSWT4025...	RSWT4055...
30	10	15	RSWT4032...	RSWT4032...	RSWT4055...
37	10	18.5	RSWT4037...	RSWT4037...	RSWT4070...
45	15	22	RSWT4045...	RSWT4045...	RSWT4090...
55	20	30	RSWT4055...	RSWT4055...	■
70	25	37	RSWT4070...	RSWT4070...	■
85	30	45	RSWT4090...	RSWT4090...	■

Motor FLC [A]	HP Rating @ 480 V	HP Rating @ 600 V	Trip class 5	Trip class 10	Trip class 20
2.7	1.5	2	RSWT6012...	RSWT6012...	RSWT6012...
3.9	2	3	RSWT6012...	RSWT6012...	RSWT6012...
5	3	4	RSWT6012...	RSWT6012...	RSWT6012...
6	3	5	RSWT6012...	RSWT6012...	RSWT6012...
9	5	7.5	RSWT6012...	RSWT6012...	RSWT6025...
11	7.5	10	RSWT6012...	RSWT6012...	RSWT6032...
16	10	15	RSWT6016...	RSWT6016...	RSWT6032...
22	15	20	RSWT6025...	RSWT6025...	RSWT6045...
27	20	25	RSWT6032...	RSWT6032...	RSWT6055...
32	20	30	RSWT6032...	RSWT6032...	RSWT6070...
41	30	40	RSWT6045...	RSWT6045...	RSWT6090...
52	40	50	RSWT6055...	RSWT6055...	■
65	45	60	RSWT6070...	RSWT6070...	■
77	55	75	RSWT6090...	RSWT6090...	■
85	60	75	RSWT6090...	RSWT6090...	■

CARLO GAVAZZI compatible components

Purpose	Component name/code	Notes
Manual motor starters	GMS-32 <input type="checkbox"/> - <input type="checkbox"/> GMS-63 <input type="checkbox"/> - <input type="checkbox"/> GMS-100 <input type="checkbox"/> - <input type="checkbox"/>	<input type="checkbox"/> : S: standard H: high breaking capacity
Finger guards	RFCG X6	6 pcs per box
Cooling fan	RFAN-75-40 12 X1	For RSWT..45 to RSWT..90 only Rated voltage : 12 VDC Power consumption: 0.6 W

Structure

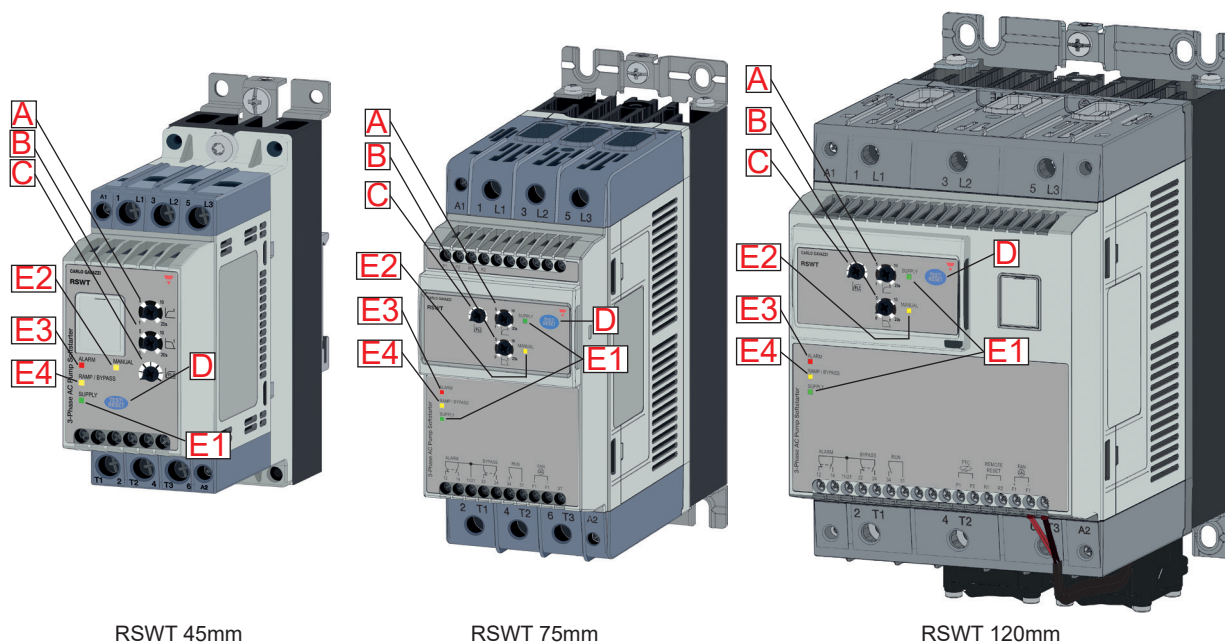

RSWT 45mm

RSWT 75mm

RSWT 120mm

Element	Component	Function
A	Ramp-up time selector	Sets the desired motor starting time.
B	Ramp-down time selector	Sets the desired motor stopping time.
C	FLC knob selector	Sets the motor full load current (FLC). The FLC is setting is used by the RSWT for the overload protection and for the maximum current allowed during motor start.
D	Test/Reset	Simulate overload alarm (press for 1 sec when RSWT is in Idle state) Set alarm recovery mode (press for 5 sec when RSWT is in Idle state) Reset alarms (press for <1 sec when RSWT is in alarm mode and alarm mode is Manual)
E1	LED indicators	Supply. Indicates that the RSWT supply is ON.
E2	LED indicators	Manual. Indicates the alarm reset mode. Manual reset mode - LED ON, Auto reset mode - LED OFF (Factory default setting: Auto, LED OFF)
E3	LED indicators	Alarm. Indicates that the RSWT is in alarm. The number of flashes indicates the alarm type.
E4	LED indicators	Ramping/bypass. Indicates whether RSWT is in ramping (flashing) or bypass (fully ON).

Mode of operation

Setting procedure

The RSWT...V10/ V110/ V111 soft starter series features 3-knob settings and an additional push button to test the overload protection, reset the alarms and for setting the alarm recovery to Manual or Auto.

Step 1: Set the ramp-up time

- Set the knob to the desired starting time as required for the specific application.

Step 2: Set the ramp-down time

- Set the knob to the desired stopping time as required for the specific application. In this case ramp-down time can be set to a different value from that of the ramp-up time.
- Note: If no soft-stop is required, set the ramp-down knob from 0 to 1sec.

Step 3: Set the full load current (FLC)*

- Adjust the knob setting to the FLC value corresponding to the pump/motor name plate to ensure proper overload protection
- * Note: Refer to section "Selection Guide and typical application settings" section on page 3 in case of Trip Class 20 loads.

Step 4: Set the alarm recovery mode

- Make sure the RSWT is in idle mode (Green LED ON)
- To set the alarm recovery to auto, press the Test/Reset button for a minimum of 5secs. The MANUAL LED (yellow LED) will turn OFF indicating that the alarms will follow an auto-recovery routine.
- To set the alarm recovery to MANUAL the same procedure as described above applies
- Note: The RSWT...V10/ V110/ V111 have a default setting of auto alarm recovery (yellow LED MANUAL OFF)

Step 5: Test the overload function

- To make sure that the overload function is working properly press the TEST/RESET button (during Idle) for about 1sec. The RSWT will trip and the red LED will flash 8 times indicating an overload alarm. The alarm relay (11,12) will also change state to Open.
Note: for RSWT32 to RSWT90 models, relay (11, 12, 14) will change state.



IMPORTANT: The RSWT knob settings are only checked during IDLE status. Changes in the knob settings during Ramping/Bypass status will only be affected during the following start/ stop.

Mode of operation

Starting Method

The RSWT series of soft starters is based on a current ramp starting methodology to limit the motor starting current and, at the same time minimise water hammering effects. Additionally, the RSWT is equipped with an intelligent and self-learning algorithm to adjust the starting torque automatically at every start. The algorithm makes use of the internal current and voltage measurement circuits to detect when the motor starts to rotate. During every start, the RSWT adjusts the starting parameters to achieve a ramp-up time as close as possible to the one set by the user. This function is done automatically by the RSWT and within 5 starts (typically) the proper starting parameters will be found (assuming the load is the same).

During ramp-down, the RSWT will use the “self-learned” parameters to adjust the ramp-down time in such a way to respect the setting done by the user on the ramp-down knob.

Important: Due to the self-learning algorithm present on the RSWT series, when the RSWT is first tested on a small motor, the starting parameters will be optimised for that motor size. If the same RSWT is then installed/ tested on a larger motor, the starting parameters will be optimised during the first start and the RSWT might trigger an alarm. If this happens, following the alarm recovery period, the RSWT will update the(self-learned) start parameters and perform another start. This process will then continue during successive starts such that the optimal starting parameters are found.

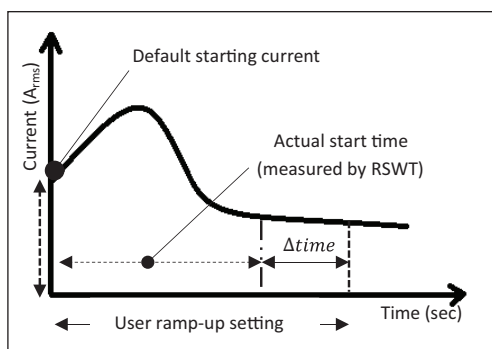

Start 1: RSWT starts from default starting voltage/torque (internal) value. The pump start time can be shorter/longer than user ramp-up setting.

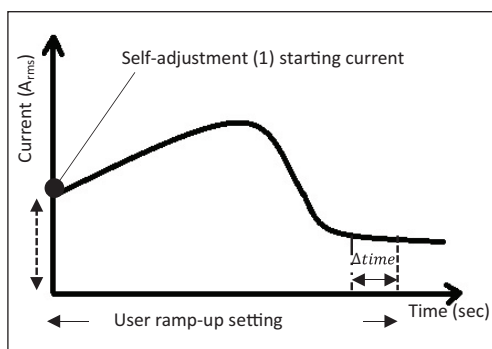

Start 2: During the 2nd start, the RSWT will start with the “self-learned” start parameters (from the previous start) to reduce the difference between the user-set ramp-time vs the actual ramp-time measured by the RSWT (Δ time).

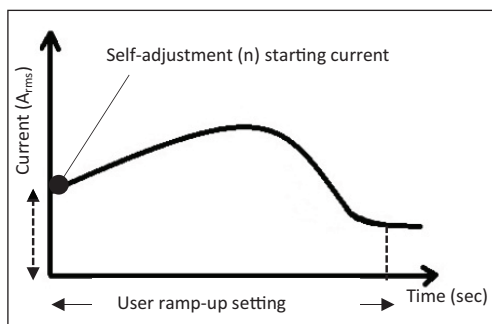

Start n: For the nth start, the RSWT algorithm will keep the ramp-time as close as possible to the user set-ramp time. The self-adjusting algorithm will remain active at every start to make sure that the RSWT adapts the starting parameters to any load changes.

Note: During motor starting, the RSWT will limit the current to a maximum of 3.5xFLC setting.

Features

General

	RSWT 45 mm	RSWT 75 mm	RSWT 120 mm
Material	PA66		
Assembly	DIN or panel		
Protection grade	IP20		
Weight	0.5 to 0.85 Kg	About 2.3 Kg	About 3.5 Kg
Overvoltage category	Cat. III		

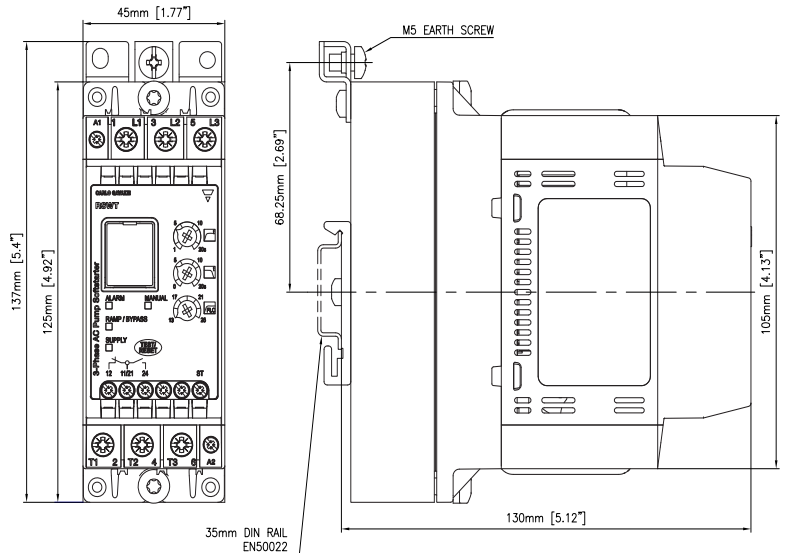

Fig. 1 RSWT 45 mm (12 Arms - 16 Arms)

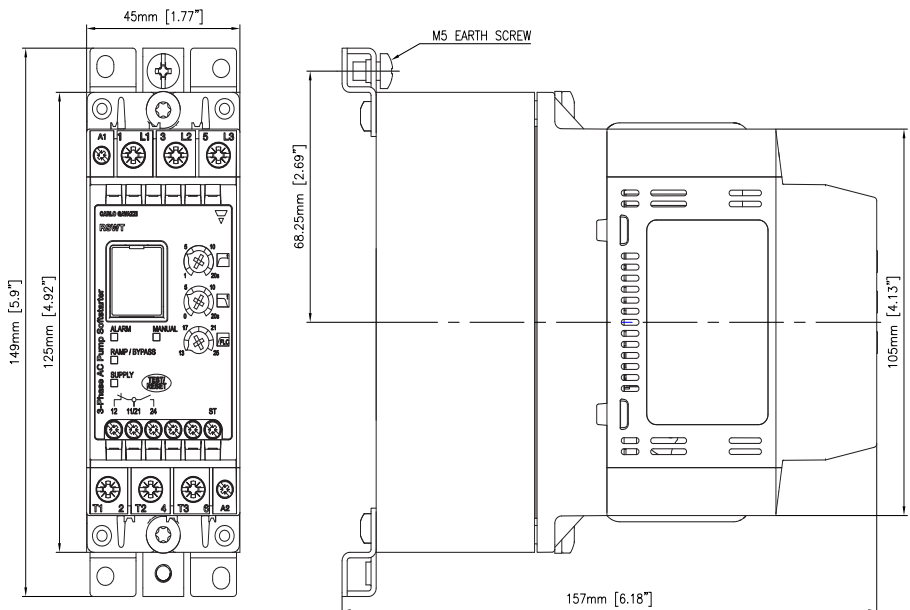

Fig. 2 RSWT 45 mm (25 Arms)

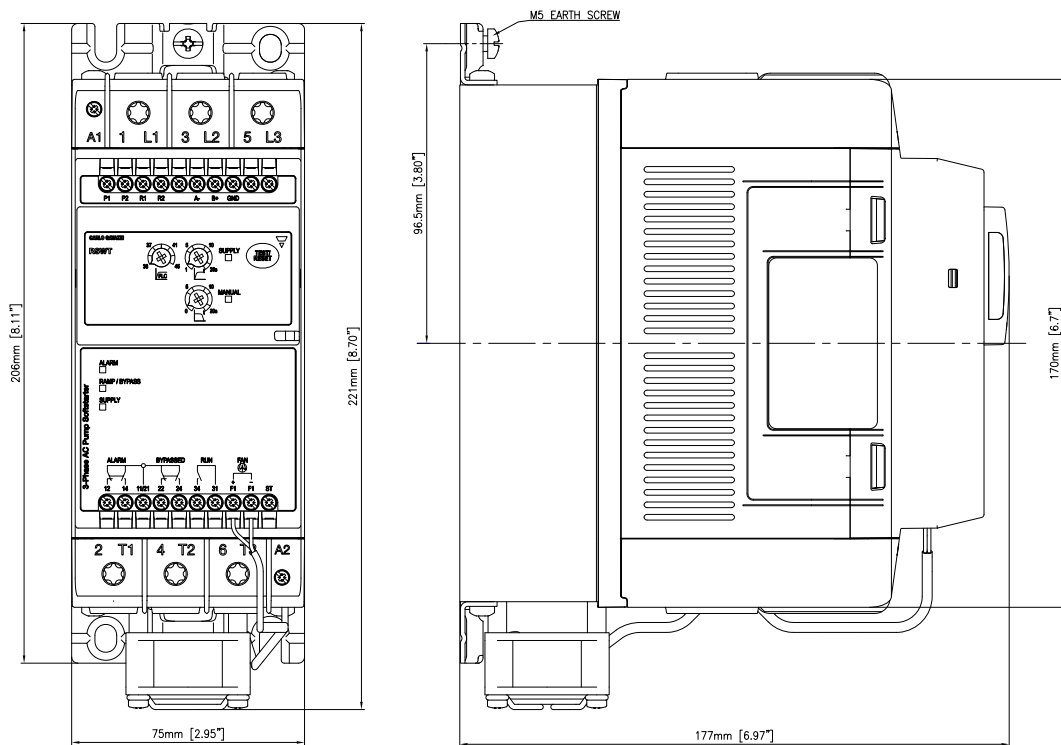

Fig. 3 RSWT 75 mm (32 Arms - 55 Arms)

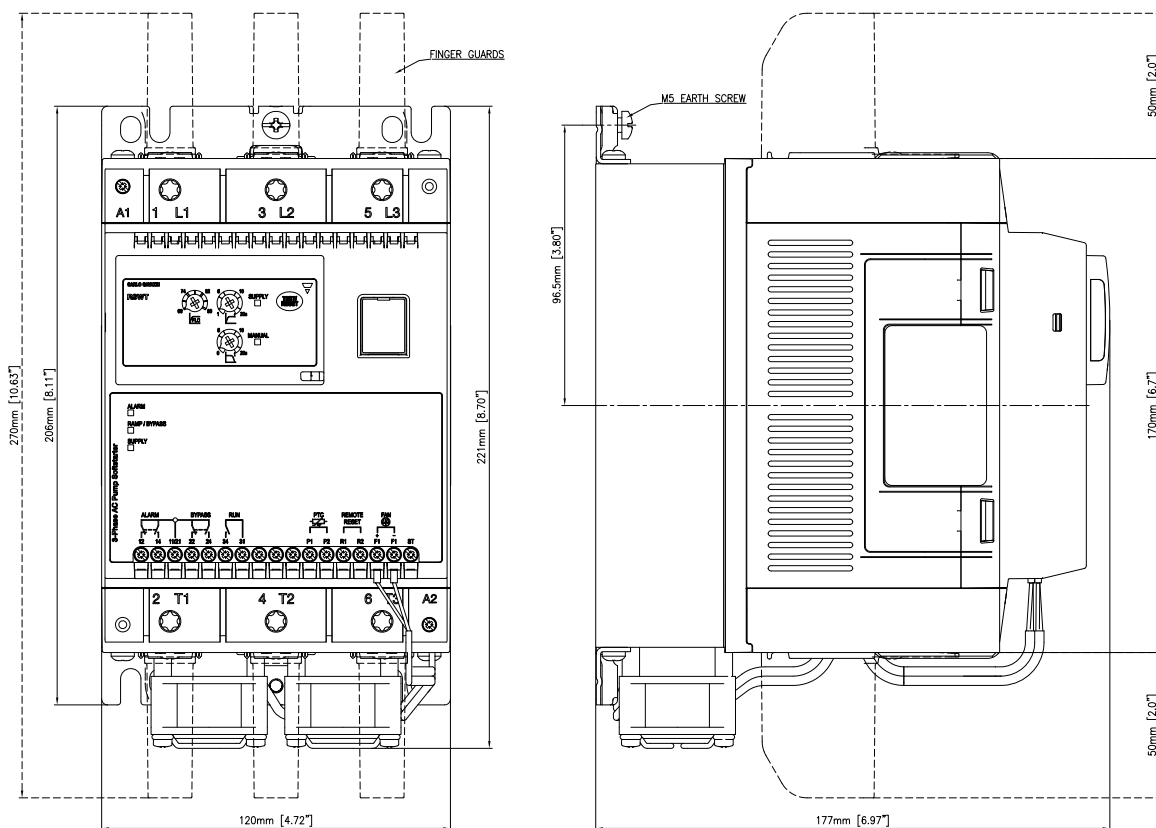

Fig. 4 RSWT 120 mm (70 Arms - 90 Arms)

Settings

	RSWT 45 mm	RSWT 75 mm	RSWT 120 mm
Ramp-up time	1 - 20 s		
Ramp-down time	0 - 20 s		
Initial torque	Automatically determined by RSWT		
FLC range settings	RSWT 12: 6 - 12 A RSWT 16: 10 - 16 A RSWT 25: 13 - 25 A	RSWT 32: 20 - 32 A RSWT 37: 25 - 37 A RSWT 45: 33 - 45 A RSWT 55: 43 - 55 A	RSWT 70: 52 - 70 A RSWT 90: 66 - 90 A

Power Supply

	RSWT40..	RSWT60..
Operational voltage range	187 - 440 VACrms	187 - 660 VACrms
Supply current at idle	< 30 mArms	
Blocking voltage	1200 Vp	1600 Vp
Rated AC frequency	50/60 Hz (+/- 10%)	
Rated insulation voltage	630 VAC	690 VAC
Dielectric withstand voltage: Supply to input Supply to heatsink	2.5 kVrms 2.5 kVrms	
Integrated varistor	Yes	

Environmental

Working temperature	-20°C to +60°C (-4°F to +140°F). Note: for temperatures > 40°C derating applies.
Storage temperature	-40°C to +80°C (-40°F to +176°F).
Relative humidity	< 95% non-condensing @ 40°C.
Pollution degree	2
Degree of Protection (control circuit)	IP20 (EN/IEC 60529)
Installation category	III
Installation altitude	1000 m

Compatibility and conformity

Conformance	IEC/EN 60947-4-2 UL508 Listed (E172877) cUL Listed (E172877) CCC
Approvals	   

Electromagnetic compatibility (EMC) - immunity

Immunity	IEC/EN 61000-6-2
Electrostatic discharge (ESD) Immunity Air discharge, 8 kV Contact, 4 kV	IEC/EN 61000-4-2 Performance Criteria 2 Performance Criteria 2
Radiated radio frequency Immunity 3 V/m, 80 - 1000 MHz	IEC/EN 61000-4-3 Performance Criteria 1
Electrical Fast Transient (Burst) Immunity Output: 2 kV Input: 1 kV	IEC/EN 61000-4-4 Performance Criteria 2 Performance Criteria 2
Conducted Radio Frequency Immunity 10 V/m, 0.15 - 80 MHz	IEC/EN 61000-4-6 Performance Criteria 1
Electrical Surge Immunity Output, line to line, 1 kV Output, line to earth, 2 kV Input, line to line, 1 kV Input, line to earth, 2 kV	IEC/EN 61000-4-5 Performance Criteria 2 Performance Criteria 2 Performance Criteria 2 Performance Criteria 2
Voltage Dips Immunity 0% for 10 ms/20 ms, 40% for 200 ms 70% for 500 ms	IEC/EN 61000-4-11 Performance Criteria 2 Performance Criteria 2 Performance Criteria 2

Electromagnetic compatibility (EMC) - emissions

Emission	IEC/EN 61000-6-3
Radio Interference field emission (Radiated) 30 - 1000 MHz	IEC/EN 55011 Class A (Industrial)
Radio interference field emissions (conducted)	IEC/EN 55011 Class A (Industrial)

Inputs

	RSWT40..E0V..	RSWT40..F0V..	RSWT60..GGV..	RSWT60..FF..
Control voltage (Uc)	A1 - A2: 110 - 400 VAC +10%, -15%	A1 - A2: 24 VAC/VDC +10%, -10%	ST: 100 - 240 VAC +10%, -15%	ST: 24 VAC/DC +10%, -10%
Control voltage range (Uc)	93.5 - 440 VAC	21.6 - 26.4 VAC/DC	85 - 264 VAC	21.6 - 26.4 VAC/DC
Maximum pick-up voltage	80 VAC	20.4 VAC/DC	80 VAC	20.4 VAC/DC
Minimum drop out voltage	20 VAC	5 VAC/DC	20 VAC	5 VAC/DC
Supply voltage range (Us)	-	-	A1 - A2: 100 - 240 VAC +10%, -15%	A1 - A2: 24 VAC/DC +10%, -10%
Rated AC frequency	45 - 66 Hz	45 - 66 Hz (applies to 24 VAC supply)		45 - 66 Hz (applies to 24 VAC supply)
Rated insulation voltage (Ui)	500 VAC			
Overvoltage category	III			
Dielectric strength: Dielectric withstand voltage Rated impulse withstand voltage	2 kVrms 4 kVrms			
Control input current	0.5....5 mA	0.4....1 mA	0.4....3 mA	0.4....1 mA
Input to output response time (Mains supply already present)	< 300 msec			
Input to output response time (Mains supply applied with control)	2.5 sec		2 sec	
Integrated varistor	Yes			

* Note 1: For the Canadian application, the control terminals A1, A2 (or A1, A2, ST for RSWT60 versions) of the RSWT devices shall be supplied by a secondary circuit where power is limited by a transformer, rectifier, voltage divider, or similar device that derives power from a primary circuit, and where the short-circuit limit between conductors of the secondary circuit or between conductors and ground is 1500 VA or less. The short-circuit volt ampere limit is the product of the open circuit voltage and the short circuit ampere.

Note 2: RSWT60 soft starters require a separate single phase control source. RSWT60...FF versions: 24 VAC/DC and RSWT60...GG versions: 100-240 VAC. Output connections (1 L1, 3 L2, 5 L3, 2 T1, 4 T2, 6 T3) are not galvanically isolated from the external supply connections (A1, A2, ST).

Outputs

	RSWT..12....	RSWT..16....	RSWT..25....	RSWT..32....	RSWT..37....
Overload cycle acc. to EN/IEC 60947-4-2 @ 40°C surrounding temperature	AC53b:4-6:174		AC53b: 3.5-5:175	AC53b: 4 - 6:174	RSWT40: AC53b: 3.5 - 6: 174 RSWT60: AC53b: 4 - 6: 174
Maximum number of starts per hour @ 40°C @ rated overload cycle	20			20	
Rated operational current @ 40°C	12 AAC	16 AAC	25 AAC	32 AAC	37 AAC
Rated operational current @ 50°C	11 AAC	15 AAC	23 AAC	29 AAC	34 AAC
Rated operational current @ 60°C	10 AAC	13 AAC	21 AAC	27 AAC	31 AAC
Minimum load current	2 AAC	2 AAC	2 AAC	5 AAC	5 AAC

	RSWT..45....	RSWT..55....	RSWT..70....	RSWT..90....
Overload cycle acc. to EN/IEC 60947-4-2 @ 40°C surrounding temperature	RSWT40: AC53b: 3.5 - 6: 174 RSWT60: AC53b: 4 - 6: 174	AC53b: 3 - 12: 168	AC53b: 4-6: 174	
Maximum number of starts per hour @ 40°C @ rated overload cycle	20			
Rated operational current @ 40°C	45 AAC	55 AAC	70 AAC	90 AAC
Rated operational current @ 50°C	41 AAC	50 AAC	64 AAC	83 AAC
Rated operational current @ 60°C	37 AAC	46 AAC	59 AAC	76 AAC
Minimum load current	5 AAC	5AAC	5 AAC	5 AAC

Note: The overload cycle describes the switching capability of the soft starter at a surrounding temperature of 40°C as described in EN/IEC 60947-4-2. An overload cycle AC53b:4-6:174 means that the soft starter can handle a starting current of 4x I_e for 6 seconds followed by an OFF time of 174 seconds.

Auxiliary relays

	RSWT..12.... - RSWT..25....	RSWT..32.... - RSWT..90....
Number of output relays	2	3
Function of relays	Alarm, bypassed (top of ramp).	Alarm, bypassed (top of ramp), run.
Rated operational voltage	250 VAC/30 VDC	
Rated insulation voltage	250 VAC	
Dielectric withstand voltage (Coil to contacts)	2.5 kV	
Overvoltage category	II	
Type of control circuit	Electromechanical relay	
Number of contacts	Alarm and bypassed: 1	Alarm and bypassed: 2 Run: 1
Type of contacts	Alarm: normally closed (NC) Bypassed: normally open (NO)	Alarm and bypassed: changeover (NO, NC) Run: normally open (NO)
Type of current	AC / DC	
Rated operational current	3 Arms @ 250 VAC, 3 Arms @ 30 VDC	

Performance

Current / power ratings: kW and HP @ 40°C

Model	IEC Rated Current	220 - 240 VAC	380 - 415 VAC	440 - 480 VAC	550 - 600 VAC
RSWT..12	12 Arms	3 kW / 3 HP	5.5 kW / 5 HP	5.5 kW / 7.5 HP	9 kW / 10 HP
RSWT..16	16 Arms	4 kW / 5 HP	7.5 kW / 7.5 HP	9 kW / 10 HP	11 kW / 15 HP
RSWT..25	25 Arms	5.5 kW / 7.5 HP	11 kW / 10 HP	11 kW / 15 HP	20 kW / 20 HP
RSWT..32	32 Arms	9 kW / 10 HP	15 kW / 15 HP	18.5 kW / 20 HP	22 kW / 30 HP
RSWT..37	37 Arms	9 kW / 10 HP	20 kW / 20 HP	22 kW / 25 HP	30 kW / 30 HP
RSWT..45	45 Arms	11 kW / 15 HP	22 kW / 25 HP	22 kW / 30 HP	37 kW / 40 HP
RSWT..55	55 Arms	15 kW / 20 HP	30 kW / 30 HP	30 kW / 40 HP	45 kW / 50 HP
RSWT..70	70 Arms	20 kW / 25 HP	37 kW / 40 HP	45 kW / 50 HP	55 kW / 60 HP
RSWT..90	90 Arms	22 kW / 30 HP	45 kW / 50 HP	55 kW / 60 HP	75 kW / 75 HP

Ratings:

kW rating according to: IEC/EN 60947-4-2

HP rating according to: UL508

Starts per hour

The table below indicates the maximum number of starts/hr that can be done by the different RSWT models at different operating currents with a surrounding temperature of 40°C.

Model	Operational current						
	6 Arms	12 Arms	16 Arms	25 Arms	32 Arms	37 Arms	45 Arms
RSWT..12	45	20	-	-	-	-	-
RSWT..16	60	25	20	-	-	-	-
RSWT..25	100	50	35	20	-	-	-
RSWT..32	-	65	45	25	20	-	-
RSWT..37	-	80	55	30	24	20	-
RSWT..45	-	100	75	40	30	25	20

Model	Operational current						
	25 Arms	32 Arms	37 Arms	45 Arms	55 Arms	70 Arms	90 Arms
RSWT..55	50	40	30	25	20	-	-
RSWT..70	70	50	45	35	25	20	-
RSWT..90	95	70	60	45	35	10	20

Connection Diagrams

Terminal markings

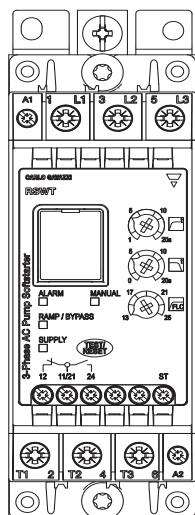

Fig. 5 RSWT 45mm

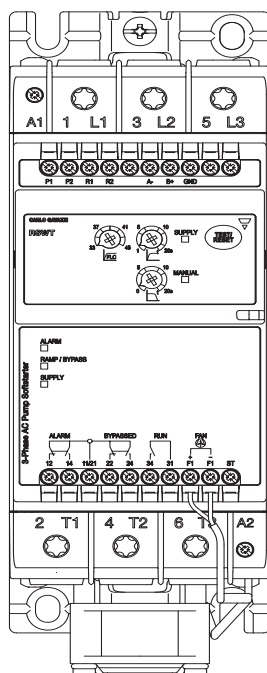

Fig. 6 RSWT 75mm

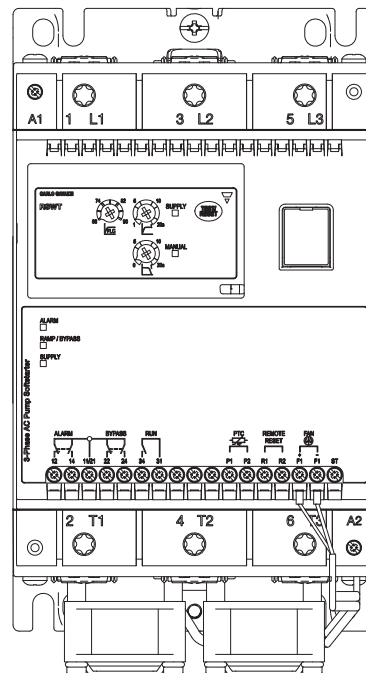
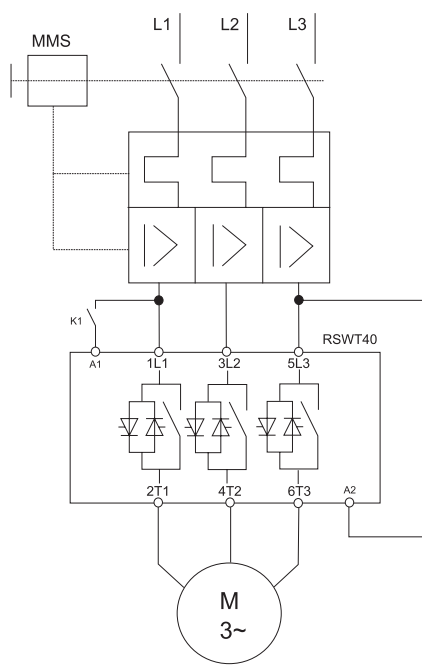

Fig. 7 RSWT 120mm

Marking	RSWT 45 mm		RSWT 75 mm / RSWT 120 mm	
	RSWT40	RSWT60	RSWT40	RSWT60
1 L1, 3 L2, 5 L3	Line connections			
2 T1, 4 T2, 6 T3	Load connections			
A1, A2	Control voltage	Supply voltage	Control voltage	Supply voltage
ST	-	Control voltage	-	Control voltage
11, 12	Alarm indication (normally closed, NC)			
11, 14	-		Alarm indication (normally open, NO)	
21, 22	-		Top of ramp indication (normally closed, NC)	
21, 24	Top of ramp indication (normally open, NO)			
31, 34	-		Run relay (normally open, NO)	
R1, R2	-		Remote reset of alarms	
P1, P2	-		PTC input	
F1+, F1- *	-		Fan connection	
Note:	For the 24 VDC (RSWT40..F0, RSWT60..FF) models, connect A1 to the positive (+) and A2 to the negative (-) terminal. * Only for RSWT..45 to RSWT..90 models			

Wiring diagrams

Valid up to 400 VAC



RSWT...E0V..

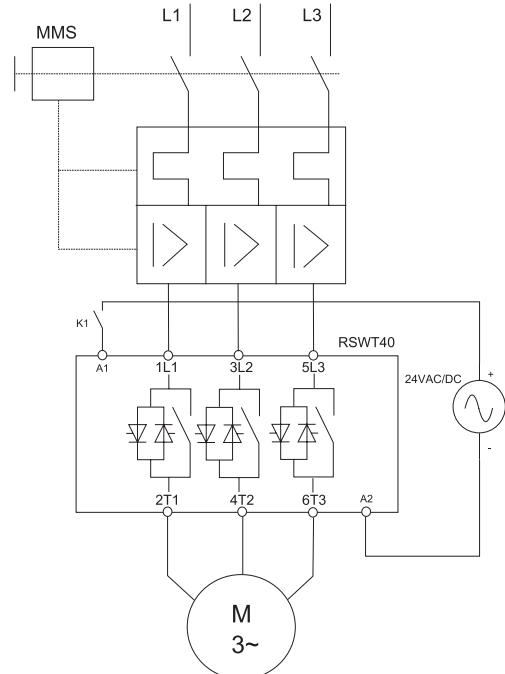

RSWT40...F0V..

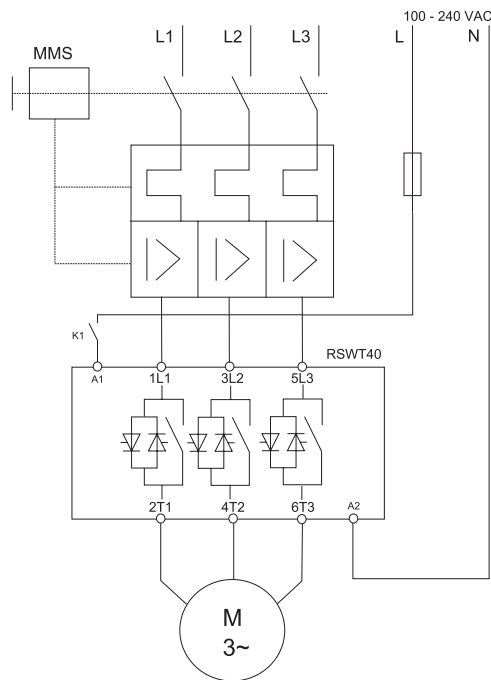

RSWT40...E0V..

Wiring diagrams

IMPORTANT: L1, L2, L3 should already be connected when A1, A2 and ST signals are applied. A minimum delay of 200ms should be allowed between switching of L1, L2, L3 and A1, A2 and ST respectively. If L1, L2 and L3 are not present, when A1, A2 is applied the “Line voltage out of range alarm will be triggered”. The alarm will automatically recover if L1, L2, L3 are within operational range for 1 sec (on power up only).

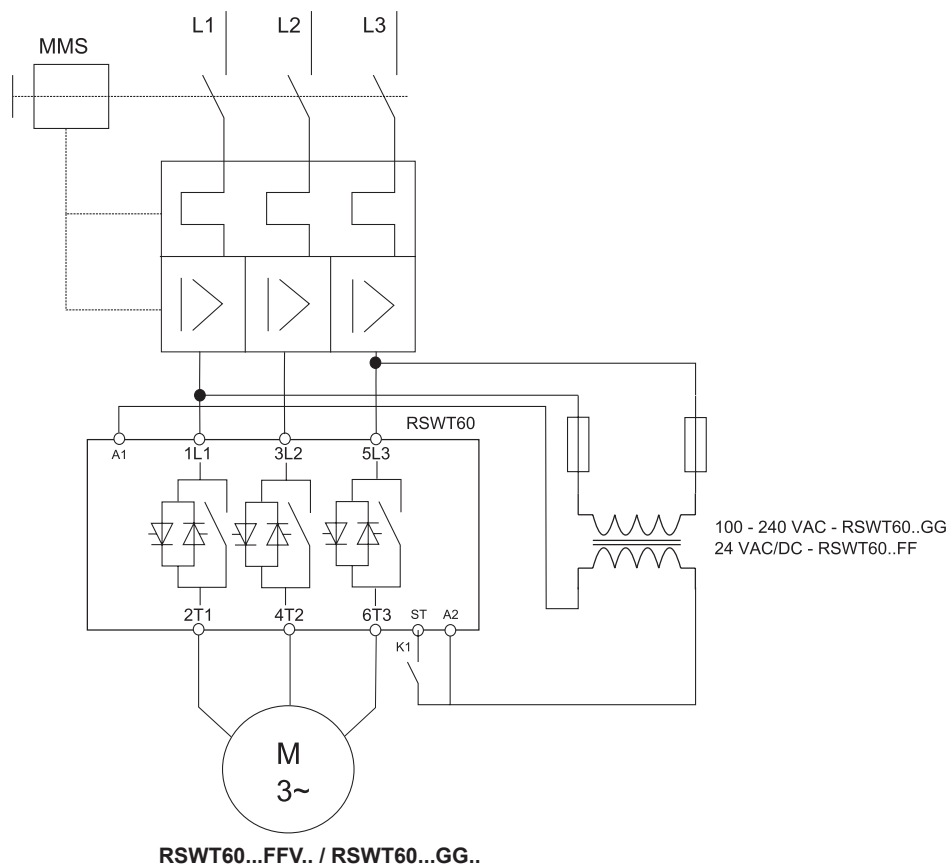

Note 1: For RSWT60..FFV... models apply 24 VAC/DC across A1, A2 terminals. For RSWT60..GGV... models apply 100 - 240 VAC across A1, A2 terminals.

Note 2: For DC supply, connect A1 to the positive (+) and A2 to the negative (-) terminal of the power supply.

Note 3: ST terminal has to be at the same potential of A2 (refer to wiring diagrams)

Connection specifications

Line conductors 1 L1, 3 L2, 5 L3, 2 T1, 4 T2, 6 T3 Acc. to EN60947-1		
	RSWT...12 to RSWT...25	RSWT...32 to RSWT...90
Flexible	2.5 - 10 mm ² 2.5 - 2 x 4 mm ²	-
Rigid (solid or stranded)	2.5 10 mm ²	2 x (10...50 mm ²)
Flexible with end sleeve (ferrule)	2.5 10 mm ²	2 x (10...50 mm ²)
UL/cUL rated data		
Rigid (stranded)	AWG 6...14	
Rigid (solid)	AWG 10...14	
Rigid (solid or stranded)	AWG2 x 10...2 x 14	2 x (AWG 8...1/0)
Terminal screws	M4	M8
Maximum tightening torque	2.5 Nm (22 lb.in) with posidrive bit 2	12 Nm (106 lb.in) with Torx TT40 bit
Stripping length	8.0 mm	20.0 mm

Secondary conductors A1, A2 Acc. to EN60998		
	RSWT...12 to RSWT...25	RSWT...32 to RSWT...90
Flexible	0.5 1.5 mm ²	
Rigid (solid or stranded)	0.5 2.5 mm ²	
Flexible with end sleeve (ferrule)	0.5 1.5 mm ²	
UL/cUL rated data		
Rigid (solid or stranded)	AWG 10...18	
Terminal screws	M3	
Maximum tightening torque	0.6 Nm (5.3 lb.in) with posidrive bit 0	
Stripping length	6.0 mm	

Auxiliary conductors 11, 12, 21, 24, (31, 34)*, ST**		
	RSWT...12 to RSWT...25	RSWT...32 to RSWT...90
Rigid (solid or stranded)	0.05 ... 2.5 mm ²	
Flexible with end sleeve (ferrule)	0.05 ... 1.5 mm ²	
UL/cUL rated data		
11, 12, 21, 24, (31, 34)*, ST	AWG 30 ... 12	
Rigid (solid or stranded)	AWG 24 ... 12	
Terminal screws	M3	
11, 12, 21, 24, (31, 34)*, ST		
Maximum tightening torque	0.45 Nm (4.0 lb.in) posidrive bit 0	
11, 12, 21, 24, (31, 34)*, ST		
Stripping length	6.0 mm	

Use 75°C Copper (Cu) conductors

* For RSWT...32 to RSWT...90 models only

** For RSWT60 models only

Troubleshooting

LED status indications

State	Supply (green LED)	Ramp/Bypass (yellow LED)	Alarm (red LED)	Manual (yellow LED)
Idle	ON	OFF	OFF	OFF/ON
Ramping	ON	Flashing	OFF	OFF/ON
Bypass	ON	ON	OFF	OFF/ON
Alarm (Auto-recovery)	ON	OFF	Flashing	OFF
Alarm (Manual recovery)	ON	OFF	Flashing	ON
Internal fault	ON	OFF	ON	OFF/ON

Relay status indication

State	Supply (green LED)	Relay contact position				
		RSWT 45 mm		RSWT 75 mm / RSWT 120 mm		
		Alarm (11, 12)	Bypass (21, 24)	Alarm (11, 12, 14)	Bypass (21, 22, 24)	Run (31, 34)
Idle	ON	Closed	Open	11, 12	21, 22	Open
Ramping	ON	Closed	Open	11, 12	21, 22	Closed
Bypass	ON	Closed	Closed	11, 12	21, 24	Closed
Alarm (Auto-recovery)	ON	Open	Open	11, 14	21, 22	Open
Alarm (Manual recovery)	ON	Open	Open	11, 14	21, 22	Open
Internal fault	ON	Open	Open	11, 14	21, 22	Open

Alarms

The RSWT includes a number of diagnostics and protection features each of which is signalled through a flashing sequence on the red LED.

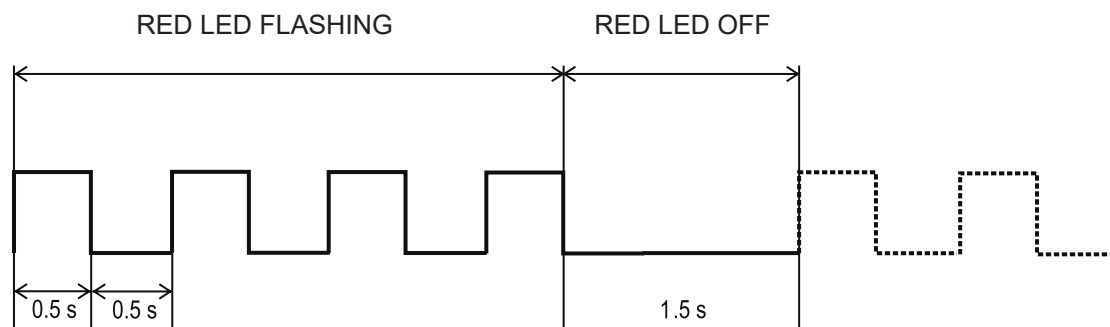

Number of flashes	2
Alarm	Wrong phase sequence
Alarm description	If the connection to the soft starter is not done in the correct sequence (L1, L2, L3), the RSWT will trigger the wrong phase sequence alarm and the motor will not be started.
Alarm recovery period	N/A
Consecutive alarms for hard reset	1
Action to recover alarm	User intervention is required to change the wiring sequence to recover alarm.
Troubleshooting	<ul style="list-style-type: none"> • Check that wiring on L1, L2, L3 is in the correct sequence. • If you need to reverse the motor, make sure that the phase sequence LED is ON (phase sequence protection disabled).

Number of flashes	3
Alarm	Line voltage out of range
Alarm description	<p>At every power-up the RSWT automatically detects the supply voltage level and determines whether it is working on a 220, 400, 480* or 600* V supply. The under- or over- voltage alarm level is then set at a level of -20% and +20% (from the measured supply voltage level) respectively.</p> <p>If the supply voltage level is out of these limits for more than 5 seconds then the line voltage out of range alarm will be triggered.</p> <p>* Applies to RSWT60 models.</p> <p>Note: For RSWT60 over-voltage alarm level (for the case of a 600 V supply) is 675 V (600 V + 11%).</p>
Alarm recovery period	5 minutes (If manual reset mode is applied, alarm can be reset by pressing the Test/Reset button).
Consecutive alarms for hard reset	4
Action to recover alarm	The alarm will self-recover (in auto-recovery mode) after 5 minutes from when the supply voltage is within limits.
Troubleshooting	<ul style="list-style-type: none"> • Check supply voltage level across L1, L2, L3 terminals. • Make sure that you are not using a RSWT40 model on a supply voltage > 440 VAC.

Number of flashes	4
Alarm	Phase loss (motor side)
Alarm description	<p>If any of the phases on the load (motor) side becomes open the RSWT will trip after 5 seconds to protect the motor from running/ starting on 2 phases.</p> <p>Note: this alarm will also be triggered when a current unbalance of > 20% is detected on any of the three line currents for a minimum of 5 secs. Additionally if a SCR and/or bypass relay is open (damaged) the same alarm will be triggered.</p>
Alarm recovery period	5 minutes (If manual reset mode is applied, alarm can be reset by pressing the Test/Reset button).
Consecutive alarms for hard reset	4
Action to recover alarm	Check connections on the output side of the soft starter and on the motor terminals. The alarm will self-recover (in Auto-recovery mode) after 5 minutes.
Troubleshooting	<ul style="list-style-type: none"> • Check for any loose connections on the T1, T2, T3 side of the soft starter. • Check for any loose connections on the motor terminals. • Check motor windings.

Number of flashes	5
Alarm	Locked rotor
Alarm description	If a current $\geq 8 \times \text{FLC}$ setting for 100 msec is detected, the RSWT will issue the locked rotor alarm.
Alarm recovery period	5 minutes (If manual reset mode is applied, alarm can be reset by pressing the Test/Reset button).
Consecutive alarms for hard reset	4
Action to recover alarm	The alarm will self-recover (in Auto-recovery mode) after 5 minutes.
Troubleshooting	<ul style="list-style-type: none"> • Check that FLC setting is not smaller than motor name plate current. • Check that the RSWT model is suitably rated for the motor. • Check motor windings resistance to check if motor is damaged.

Number of flashes	7
Alarm	Over-temperature
Alarm description	The RSWT constantly measures the heatsink and thyristors (SCRs) temperature. If the maximum internal temperature is exceeded (for a minimum of 0.5 sec) an over-temperature alarm is triggered. This condition can be triggered by too many starts per hour, an over-load condition during starting and/or stopping or a high surrounding temperature.
Alarm recovery period	Depends on the cooling period. (If MANUAL reset mode is applied, alarm can be reset by pressing the Test/Reset button). The RSWT will only recover if the internal temperature is within safe limits.
Consecutive alarms for hard reset	4
Action to recover alarm	The alarm will self-recover (in Auto-recovery mode) - the recovery period will depend on the cooling time required by RSWT. The higher the surrounding temperature, the longer the cooling period.
Troubleshooting	<ul style="list-style-type: none"> • Check that the specified number of starts/hr are not exceeded. • Check that the surrounding temperature around the soft starter is within limits.

Number of flashes	8
Alarm	Overload
Alarm description	The overload alarm can be triggered in case of the following conditions: Measured current $> 1.05 \times \text{FLC}$ during transition from ramp-up to bypass. High resistance ($> 1000 \text{ ohm}$) at P1, P2 terminals. Load current $> \text{FLC}$. Trip time will vary according to Trip Class 10.
Alarm recovery period	Depends on the cooling period. (If manual reset mode is applied, alarm can be reset by pressing the Test/Reset button). The RSWT will only recover if the internal temperature is within safe limits.
Consecutive alarms for hard reset	4
Action to recover alarm	The alarm will recover automatically after 5 minutes. If manual reset mode is enabled, press Test/Reset button. Note: allow enough time for the motor to cool before attempting the next start.
Troubleshooting	<ul style="list-style-type: none"> • Check that the P1, P2 terminals are shorted (unless PTC is used). • Make sure that the FLC setting is according to the current on the motor name plate. • Check for any blockages in the load. • If overload alarm occurs during ramp-up try to set a shorter ramp-up time or increase the FLC setting.

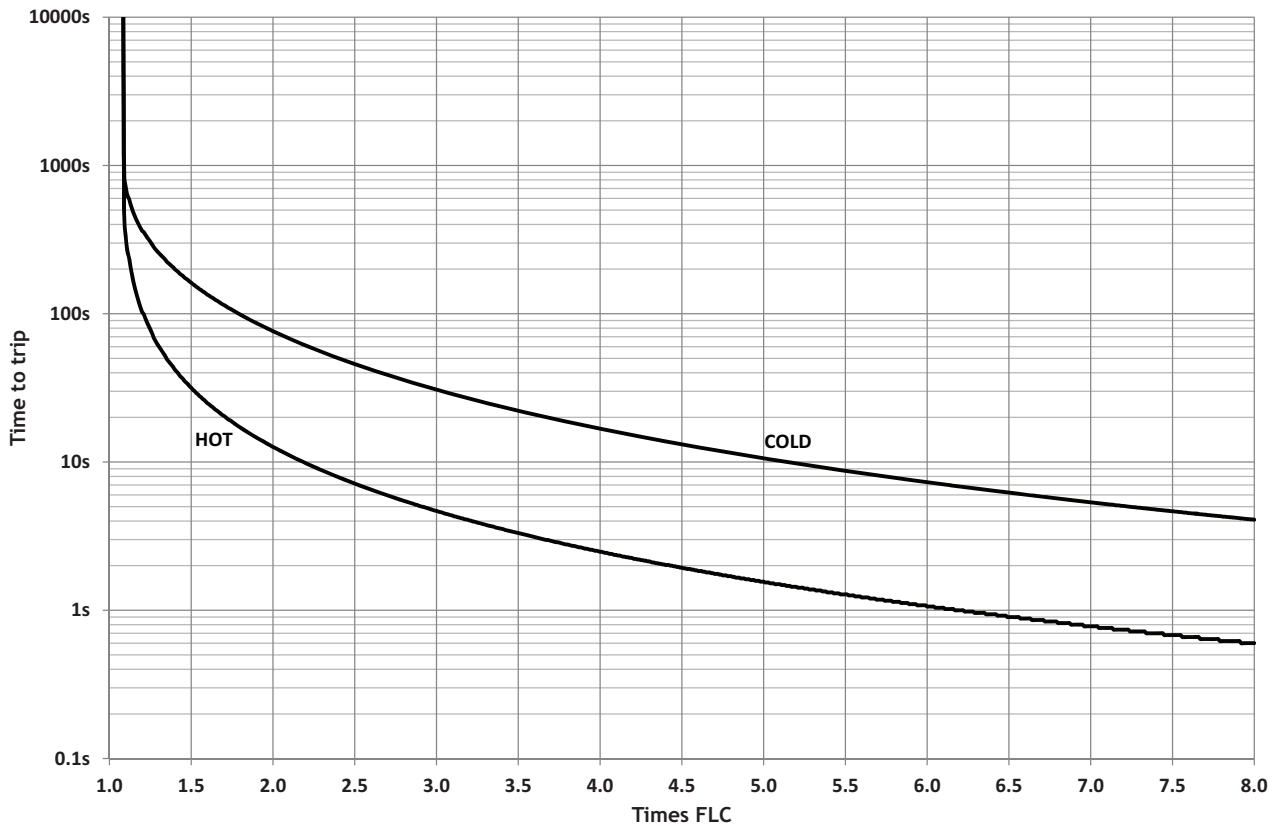

Fig. 8 RSWT Class 10 motor overload trip profile

PTC resistance - P1, P2 connection		
< 500Ω	No Trip	Normal running
> 1000Ω	Trip	Overload alarm (8 flashes) & alarm relay activated
< 300Ω	Reset	

Note: Applies to RSWT 75 mm models only.

Number of flashes	9
Alarm	Supply voltage unbalance
Alarm description	The RSWT measures the voltages on all the three phases and if there is a difference of more than 20% for ≥ 5sec between any of the phases, the RSWT will trigger the voltage unbalance alarm.
Alarm recovery period	5 minutes
Consecutive alarms for hard reset	4
Action to recover alarm	The alarm will recover automatically after 5 minutes. If manual reset mode is enabled, press Test/Reset button.
Troubleshooting	<ul style="list-style-type: none"> • Check supply voltage level across L1, L2, L3 terminals. • Check connections on the L1, L2, L3 terminals.

Number of flashes	10
Alarm	Shorted thyristor (SCR)
Alarm description	In case the RSWT detects that there is a damaged (shorted) thyristor (SCR) on any of the three phases, the soft starter will trip.
Alarm recovery period	-
Consecutive alarms for hard reset	1
Action to recover alarm	Note: this alarm is not resettable and it is suggested to replace the unit and contact a Carlo Gavazzi representative should this alarm occur.
Troubleshooting	<ul style="list-style-type: none"> • Check resistance across L1-T1 and L3-T3 to check for any short. • If any of the SCRs is damaged, replace the soft starter.

Number of flashes	Fully ON
Alarm	Internal fault
Alarm description	In case there is an internal fault in the RSWT circuitry, the Red LED will remain continuously ON.
Alarm recovery period	-
Consecutive alarms for hard reset	1
Action to recover alarm	Note: this alarm is not resettable and it is suggested to replace the unit and contact a Carlo Gavazzi representative should this alarm occur.
Troubleshooting	<ul style="list-style-type: none"> • Check resistance across L1 - T1 and L3 - T3 to check for any short. • If any of the SCRs is damaged, replace the soft starter.

Remote reset of alarms (R1, R2)*	<p>To reset alarms via the R1-R2 terminals you need to:</p> <p>Make sure that the alarm reset mode is set to MANUAL (MANUAL LED ON). To set the alarm reset mode to MANUAL press the Test/Reset button for 5 seconds when the RSWT is in IDLE mode.</p> <p>When RSWT is in alarm mode, short the terminals R1, R2 for 1 second. This will clear the alarm and RSWT will go to IDLE state.</p> <p>Note: do not apply voltage on R1, R2 terminals as this might damage the soft starter.</p>
---	--

* Applies to RSWT 75 mm / RSWT 120 mm models only

Short circuit protection

Protection Co-ordination, Type 1 vs Type 2:

Type 1 protection implies that after a short circuit, the device under test will no longer be in a functioning state.

In Type 2 co-ordination the device under test will still be functional after the short circuit. In both cases, however the short circuit has to be interrupted. The fuse between enclosure and supply shall not open. The door or cover of the enclosure shall not be blown open. There shall be no damage to conductors or terminals and the conductors shall not separate from terminals. There shall be no breakage or cracking of insulating bases to the extent that the integrity of the mounting of live parts is impaired. Discharge of parts or any risk of fire shall not occur.

The product variants listed in the table hereunder are suitable for use on a circuit capable of delivering not more than 5,000A* rms Symmetrical Amperes, 400 or 600 Volts maximum when protected by fuses. Tests at 5,000A* were performed with Class RK5 fuses, fast acting; please refer to the table below for maximum allowed ampere rating of the fuse. Use fuses only.

* For RSWT..70, RSWT..90 models 10,000 symmetrical amperes apply.

Co-ordination Type 1 (UL508) – Time Delay Fuses

Part No.	Max. fuse size [A]	Class	Current [kA]	Max. voltage [VAC]
RSWT..12.V....	20	RK5	5	600
RSWT..16.V....	20	RK5	5	600
RSWT..25.V....	25	RK5	5	600
RSWT..32.V....	60	RK5	5	600
RSWT..37.V....	60	RK5	5	600
RSWT..45.V....	60	RK5	5	600
RSWT..55.V....	60	RK5	5	600
RSWT..70.V....	100	RK5	10	600
RSWT..90.V....	100	RK5	10	600

Co-ordination Type 1 – Manual Motor Starters

Item No.	Model No.	Current [kA]	Max. voltage [VAC]
RSWT..12.V....	GMS32H-17A	5 / 3	400 / 600
RSWT..16.V....	GMS32H-17A	5 / 3	400 / 600
RSWT..25.V....	GMS32H-32A	5 / 3	400 / 600
RSWT..32.V....	GMS32H-32A	10	400
RSWT..37.V....	GMS63H-40A	10	400
RSWT..45.V....	GMS63H-50A	10	400
RSWT..55.V....	GMS63H-63A	10	400
RSWT..70.V....	GMS100S-75A	10	400
RSWT..90.V....	GMS100S-100A	10	400

Products protected with manual motor starters must be wired with a minimum length of 1.5 m Cu wire conductor. For products rated 12, 16, 25 A the maximum cross sectional area shall be of 2.5 mm², for products rated 32, 37, 45, 55 A the maximum cross-sectional area shall be of 16 mm² and for products rated 70, 90 A this shall be of a maximum of 50 mm².

The length includes the conductors from the voltage source to the manual motor starter, from the manual motor starter to the soft starter and from the soft starter to the load.