

CUSTOMER'S NAME

MOUSER ELECTRONICS

ALPHA REFERENCE NO.



SP19070081

## SPECIFICATION

PART NO.	ALPHA MODEL NAME
	RV16AF-20-15S1-A100K-LA
	313-1510F-100K

MODEL NAME
MODEL NO.

APPROVAL

PREPARED BY	REVIEWED BY	APPROVED BY
 2019.7.13 彩霞	 2019-7-13 延玲	 2019.7.15 祖衛



台灣艾華電子工業股份有限公司

33045 桃園市桃園區中正路 1221 號 9 樓

TAIWAN ALPHA ELECTRONIC CO., LTD.

9F, No. 1221, Chung Cheng Rd., Taoyuan Dist., Taoyuan City, 330 Taiwan

Tel: 886-3-3577799 Fax: 886-3-3577700

EMAIL: sales@taiwanalpha.com.tw

URL: <http://www.taiwanalpha.com>

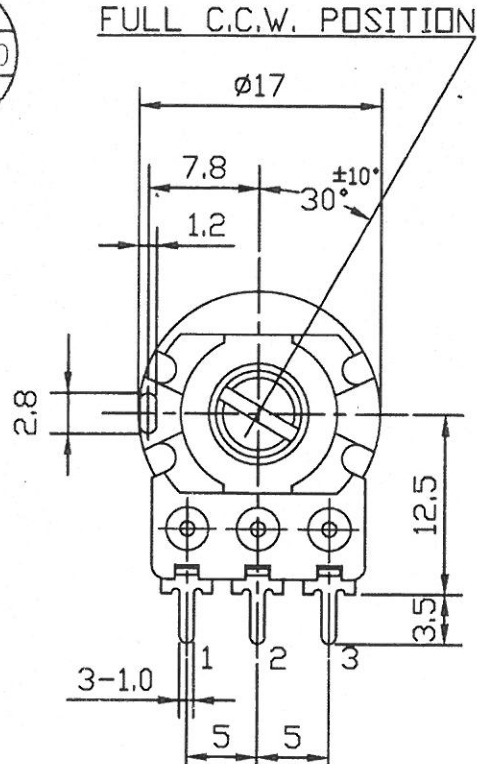
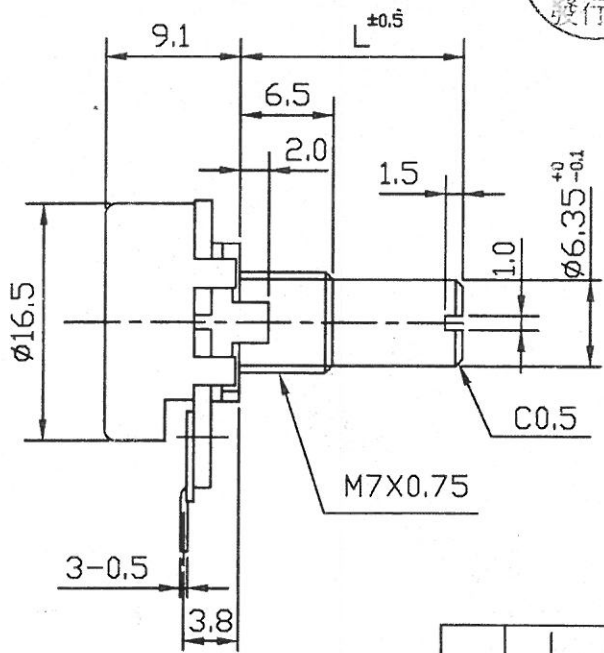

NUT 1 PC

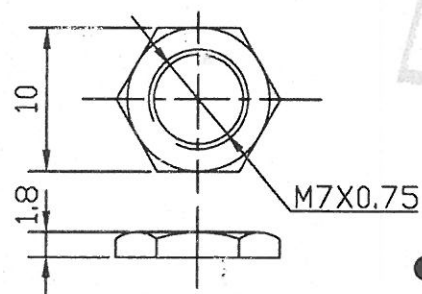

WASHER 1 PC t=0.4

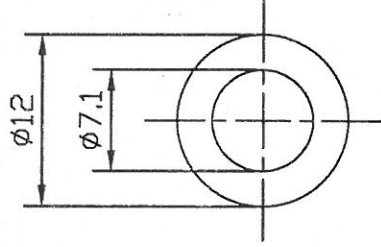

	L
	15

MOUNTING HOLE DETAIL (VIEWPOINT OF SHAFT)

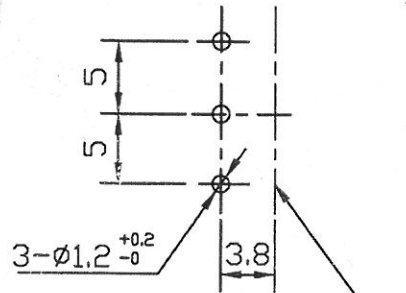

MOUNTING SURFACE

● 300° ROTATION MONO UNIT

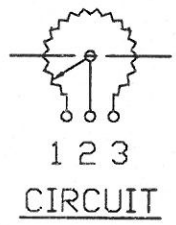

CIRCUIT



						(-LA)	
						(-0038A)	
						RV16AF-20-(L)S1-XXX(-0C)	
NO.	DATE	DESCRIPTION		MODEL NAME			
TOL. UNLESS OTHERWISE STATED		DIMENSION	SCALE	DRAWN BY	CHECKED BY	APPROVED BY	DRAWING NO.
less than 10		mm	2	姚		潘	
±0.3							
above 10 ~ 30			1	榕偉		坤	
±0.5							
above 30 ~ 100							
±1.0							
above							
±5°							

## 16Ø 單軸單連迴轉式 VR 規格書

## SPECIFICATIONS OF 16Ø ROTARY POTENTIOMETER

## 一、機械規格 MECHANICAL CHARACTERISTICS :

- 1.1 全迴轉角度：300 ± 5 度  
OVERALL ROTATION ANGLE : 300 ± 5° .
- 1.2 迴轉轉矩：20~200gf-cm (迴轉速度 60 度 / 1 秒)  
OPERATION TORQUE : 20~200gf-cm . ( ROTATIONAL SPEED 60° / 1 sec )
- 1.3 起動迴轉轉矩：450gf-cm 以下  
STARTING TORQUE : 450gf-cm MAX .
- 1.4 軸鬆動：固定腳焊錫後軸前端加上 500gf-cm 之力矩，於軸前端移動之  
0.7 × L / 30 mm P-P 以內 .  
PLAY OF SHAFT : THE RESISTOR SHALL BE MOUNTED BY SOLDERING THE MOUNTING LEGS ON THE PANEL, AND AN END THRUST OF 500gf-cm AT THE END OF THE SHAFT SHALL BE APPLIED .  
THEN THE TOTAL PLAY OF THE SHAFT SHALL BE NOT EXCEED 0.7 × L / 30 mm P-P .
- 1.5 軸擠壓引張強度：焊錫後擠壓，引張耐 8kgf，3 秒（指施加於垂直軸之端面而言）不可有電氣或機械上的異常 .  
STRENGTH OF SHAFT AGAINST END THRUST :  
THE SHAFT SHALL WITHSTAND AGAINST END THRUST OF NOT LESS THAN 8kgf FOR 3 SECONDS .
- 1.6 軸之迴轉止動強度：6kgf-cm 以上 .  
SHAFT END STOP STRENGTH : 6kgf-cm MIN .
- 1.7 軸橫擠壓強度：鉚錫後軸前端垂直方向耐 3kgf-cm，3 秒後不可有電氣或機械上的異常 . ( 1.6，1.7 項並不包含鉚錫部位之浮起 )  
ROBUSTNESS OF SHAFT AGAINST SIDE THRUST :  
THE SHAFT SHALL WITHSTAND AGAINST SIDE THRUST OF NOT LESS THAN 3kgf-cm FOR 3 SECONDS ON THE END OF THE SHAFT AT RIGHT ANGLES TO THE AXIS OF THE SHAFT AFTER MOUNTING THE RESISTOR BY SOLDERING .
- 1.8 鉚錫耐熱性：鉚錫後,不可發生顯著之鬆動接觸不良  
RESISTANCE TO SOLDERING HEAT :  
AFTER SOLDERING, THERE SHALL BE NO EVIDENCE OF POOR CONTACT BETWEEN RESISTANCE ELEMENT AND TERMINALS , OR ANY PHYSICAL DAMAGES AS A RESULT OF THE TEST .

- 1.9 軸承螺絲固定強度：7kgf-cm 以上。  
BUSHING MOUNT STRENGTH：7kgf-cm MIN.
- 1.10 CLICK 位置：150 ± 2.5°  
POSITION OF CLICK：150 ± 2.5°
- 1.11 CLICK 脫出力：30~250gf-cm  
TORQUE OF CLICK：30~250gf-cm  
☆ (1.10, 1.11 僅適用於附 CLICK 時)  
(1.10, 1.11 IS USED FOR CLICK ONLY)

二、電器規格 ELECTRICAL CHARACTERISTICS：

- 2.1 全阻值：阻值適用範圍 1KΩ~500KΩ (容許差 ± 20%)  
OVERALL RESISTANCE RANGE：1KΩ~500KΩ (TOLERANCE± 20%)
- 2.2 額定功率：B 線性 0.125W。 B 以外線性 0.06W  
POWER RATING：B TAPER 0.125W。 EXCEPT B 0.06W
- 2.3 殘留阻值：1~2 端子 / 2~3 端子同。  
RESIDUAL RESISTANCE：terminal 1~2 / 2~3

公稱阻抗值 (KΩ) OVERALL RESISTANCE (KΩ)	殘留阻值 (Ω) MAXIMUM ATTENUATION LEVEL (Ω)
R ≤ 20	10 以下 10MAX
20 < R ≤ 100	20 以下 20MAX
100 < R ≤ 1M	50 以下 50MAX

2.4 阻抗變化特性 TAPER：

阻抗變化 特性 Taper	測定角 度 Test point	端子 1-2 間輸出電壓 $\frac{V_{1-2}}$	端子 2-3 間輸出電壓 $\frac{V_{2-3}}$
		端子 1-3 間輸出電壓 $\frac{V_{1-3}}$ (%)	端子 1-3 間輸出電壓 $\frac{V_{1-3}}$ (%)
A	150°	10-25	
B	150°	40-60	
* C	* 150°		10-25
D(10A)	150°	6-15	
* E(25C)	* 150°		15-35
K(25A)	150°	15-35	
W(4B)	90±5°	5-15	
	150°	40-60	
	210±5°	85-95	
M	75±5°	40-60	
	150°	98-100	
* N	* 75±5°		40-60
	* 150°		98-100
* X(10C)	* 150°		6-15

(註) \* 記號表示自第三端子測起 \* WITH RESPECT TO TERMINAL 3

- 2.5 轉動雜音：依 JIS 測定法 47mV 以下 ( W : 200mv 以下 ) .  
ROTATION NOISE ( REFER TO JIS ) : 47mV MAX . ( W : 200mV MAX ) .
- 2.6 絕緣阻抗：D.C 500V 須在 100MΩ 以上  
INSULATION RESISTANCE : 100MΩ MIN . AT D.C 500 VOLTS
- 2.7 耐電壓：A.C 500V 可耐 1 分鐘以上  
DIELECTRIC TEST : UNITS SHALL BE DESIGNED TO WITHSTAND  
500 VOLTS BETWEEN RESISTANCE ELEMENTS  
AND CASE FOR A PERIOD OF ONE MINUTE  
WITHOUT DAMAGE OR ARCING .
- 2.8 最高使用電壓：A.C 150V .  
MAXIMUM OPERATING VOLTAGE : 150V A.C

三、耐久性能 ENDURANCE CHARACTERISTICS :

- 3.1 電阻體迴轉壽命特性：15,000 迴轉以上  
ROTATIONAL LIFE : MORE THAN 15,000 CYCLES

四、其他之性能 依照 JISC 6443 普通級碳素系可變電阻器：

NOTE MEET OR EXCEED JISC 6443 REQUIREMENTS .

- 4.1 使用溫度：-10°C~+70°C  
Operating temperature range: -10°C~+70°C
- 4.2 儲存溫度：-25°C~+75°C  
Storage temperature range : -25°C~+75°C

# STANDARD RESISTANCE TAPER

## 15A TAPER (JIS:A)

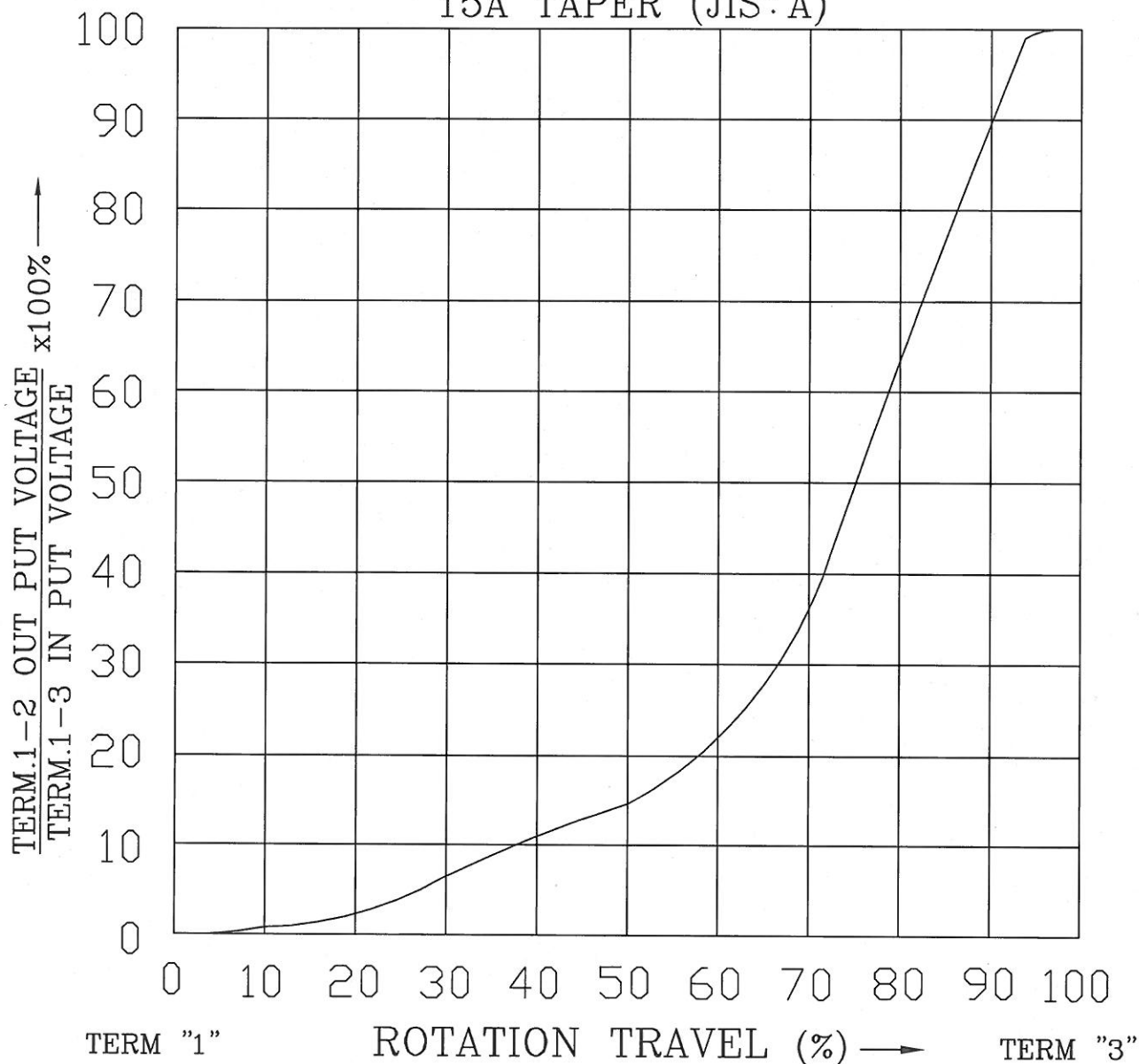

NO.	DATE	DESCRIPTION			MODEL NAME		
TOL. UNLESS OTHERWISE STATED	DIMENSION	SCALE	DRAWN BY	CHECKED BY	APPROVED BY	DRAWING NO.	
less than 10 ±0.3	mm		何	王	王		
above 10 ~ 30 ±0.5			90.8.21	90.8.21	90.8.21		
above 30 ~100 ±1.0			建志	茂松	茂松		
above ±5°							