

S3AB-HF Thru. S3MB-HF

Reverse Voltage: 50 to 1000 Volts

Forward Current: 3.0 Amp

RoHS Device

Halogen Free

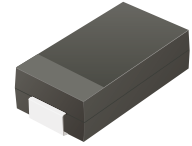

Features

- For surface mounted applications.
- Low profile package.
- Glass passivated chip junction.
- Easy to pick and place.

Mechanical data

- Case: SMB
- Terminals: Solderable per MIL-STD-750, method 2026.

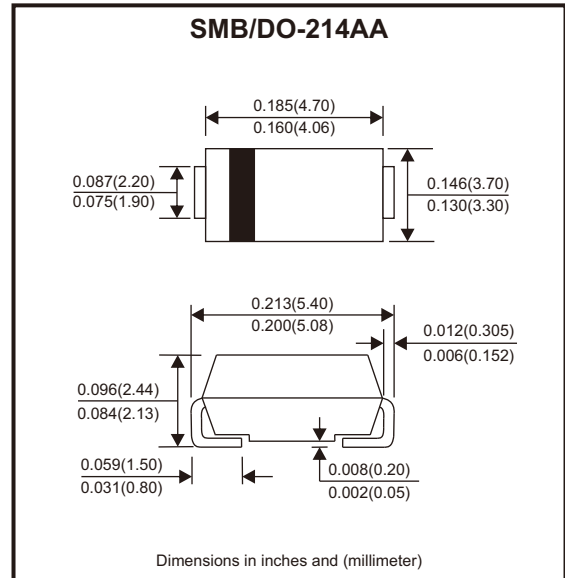

Circuit Diagram



Maximum Ratings and Electrical Characteristics

Ratings at 25°C ambient temperature unless otherwise specified.

Single phase, half wave, 60Hz resistive or inductive load, for capacitive load, derate by 20%

| Parameter | Symbols | S3AB-HF | S3BB-HF | S3DB-HF | S3GB-HF | S3JB-HF | S3KB-HF | S3MB-HF | Units |
|--|------------------------------------|------------|---------|---------|---------|---------|---------|---------|---------------|
| Maximum repetitive peak reverse voltage | V_{RRM} | 50 | 100 | 200 | 400 | 600 | 800 | 1000 | V |
| Maximum RMS voltage | V_{RMS} | 35 | 70 | 140 | 280 | 420 | 560 | 700 | V |
| Maximum DC blocking voltage | V_{DC} | 50 | 100 | 200 | 400 | 600 | 800 | 1000 | V |
| Maximum average forward rectified current | $I_{F(AV)}$ | 3 | | | | | | | A |
| Peak forward surge current, 8.3ms single half sine-wave superimposed on rated load | I_{FSM} | 90 | | | | | | | A |
| Max instantaneous forward voltage at 3A | V_F | 1.1 | | | | | | | V |
| Maximum DC reverse current at rated DC blocking voltage | I_R | 5 100 | | | | | | | μA |
| Typical junction capacitance (Note 1) | C_j | 35 | | | | | | | pF |
| Typical thermal resistance (Note 2) | $R_{\theta JA}$ $R_{\theta JC}$ | 48 16 | | | | | | | $^{\circ}C/W$ |
| Operating and storage temperature range | T_j, T_{stg} | -55 ~ +150 | | | | | | | $^{\circ}C$ |

Notes: 1. Measured at 1 MHz and applied reverse voltage of 4 V D.C

2. P.C.B. mounted with 2.0" X 2.0" (5 X 5 cm) copper pad areas.

Company reserves the right to improve product design , functions and reliability without notice.

REV:A

Rating and Characteristic Curves (S3AB-HF Thru. S3MB-HF)

Fig.1 - Forward Current Derating Curve

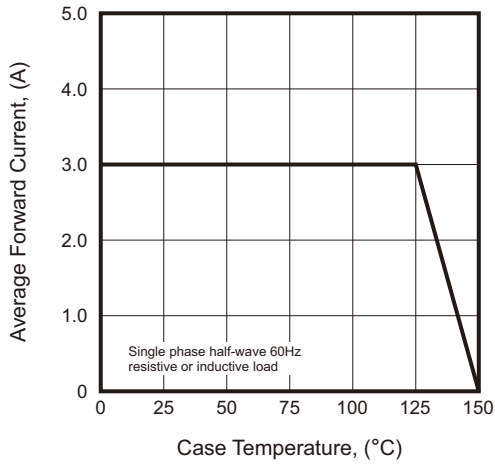

Fig.2 - Typical Instantaneous Reverse Characteristics

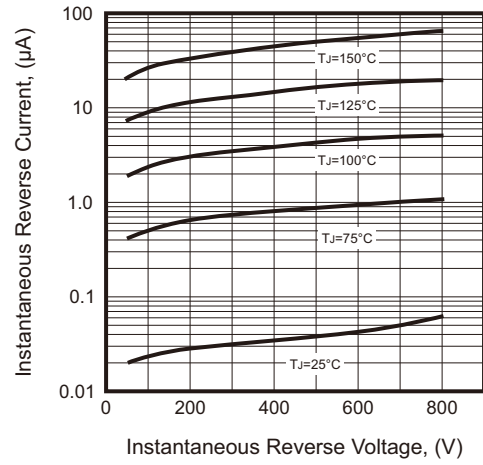

Fig.3 - Typical Forward Characteristic

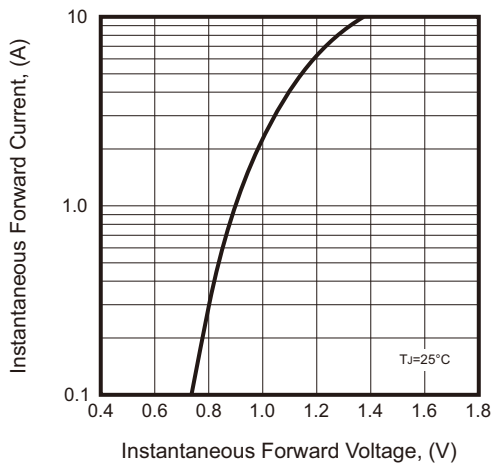

Fig.4 - Typical Junction Capacitance

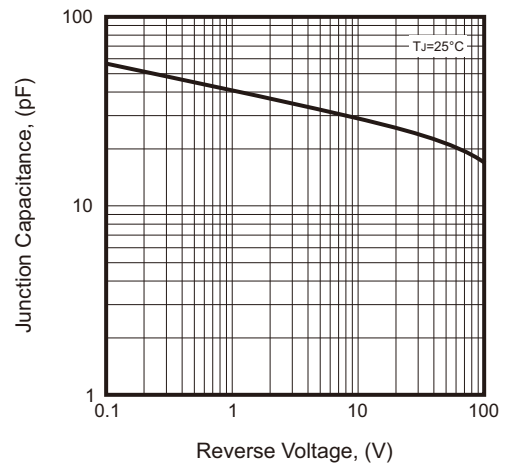
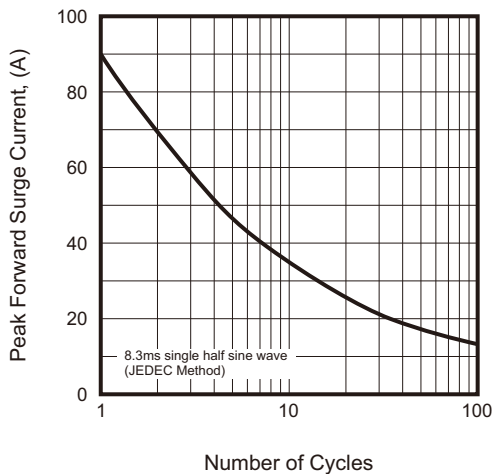
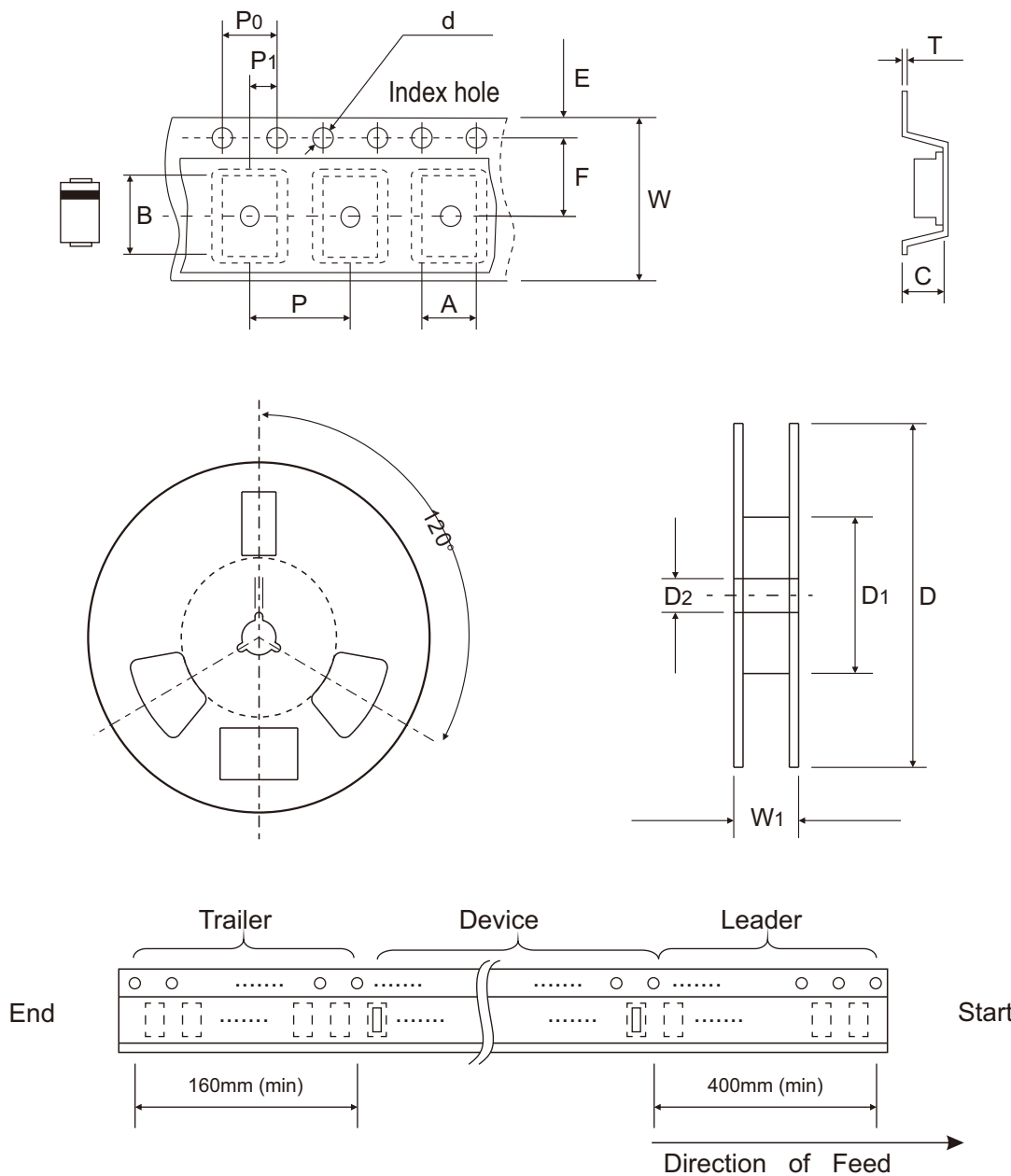

Fig.5 - Maximum Non-Repetitive Peak Forward Surge Current



Reel Taping Specification



| DO-214AA (SMB) | SYMBOL | A | B | C | d | D | D1 | D2 |
|-------------------|--------|---------------|--------------------------|---------------|---------------|----------------|---------------|---------------|
| | (mm) | 3.80 ± 0.10 | 5.50 + 0.05 - 0.10 | 2.45 ± 0.05 | 1.55 ± 0.05 | 330 ± 2.00 | 100 ± 1.00 | 13.00 ± 0.20 |
| | (inch) | 0.150 ± 0.004 | 0.217 + 0.002 - 0.004 | 0.096 ± 0.002 | 0.061 ± 0.002 | 12.992 ± 0.079 | 3.937 ± 0.039 | 0.512 ± 0.008 |

| DO-214AA (SMB) | SYMBOL | E | F | P | P0 | P1 | T | W | W1 |
|-------------------|--------|---------------|---------------|---------------|---------------|---------------|---------------|---------------|--------------------------|
| | (mm) | 1.75 ± 0.10 | 5.50 ± 0.05 | 8.00 ± 0.10 | 4.00 ± 0.10 | 2.00 ± 0.05 | 0.25 ± 0.05 | 12.00 ± 0.15 | 18.00 + 2.00 - 1.00 |
| | (inch) | 0.069 ± 0.004 | 0.217 ± 0.002 | 0.315 ± 0.004 | 0.157 ± 0.004 | 0.079 ± 0.002 | 0.010 ± 0.002 | 0.472 ± 0.006 | 0.709 + 0.079 - 0.039 |

Company reserves the right to improve product design, functions and reliability without notice.

REV:A