

# 10BASE-T NETWORK COMPONENTS

960051B

- Designed for use with Level One 10Base-T chipset LXT901 LXT907, LXT914 or Texas Instruments Quad PHY (TNETE 2004)
- 1:1 or 1:√2 turns ratio on transmit, 1:1 turns ratio on receive
- Single port components, available with and without common mode chokes
- Through-hole and surface mount packaging
- Models with additional differential filtering available
- 2000 Vrms isolation

## ELECTRICALS AT 25°C

Part No.	Insertion Loss (dB) Max		Return Loss (dB) Min	Crosstalk (dB) Min	Attenuation (dB) Min			CM-CM Rej (dB) Min		Package Style
	1-10MHz	10-100MHz			1-10MHz	1-10MHz	10-100MHz	10-30MHz	30-100MHz	
A553-0716-00	-1.0	140	-18	-40	N/A	N/A	N/A	A	1	
A553-5999-64	-1.0	200	-18	-40	N/A	N/A	N/A	A	1	
S553-0716-00	-1.0	140	-18	-40	N/A	N/A	N/A	A	2	
S553-5999-08	-1.0	110	-15	-40	N/A	-40	-30	B	2	
S556-5999-26	-1.0	110	-15	-40	-5	-10	-16	C	2	
S556-5999-53	-1.0	110	-15	-40	-5	-10	-16	C	3	

## SCHEMATICS

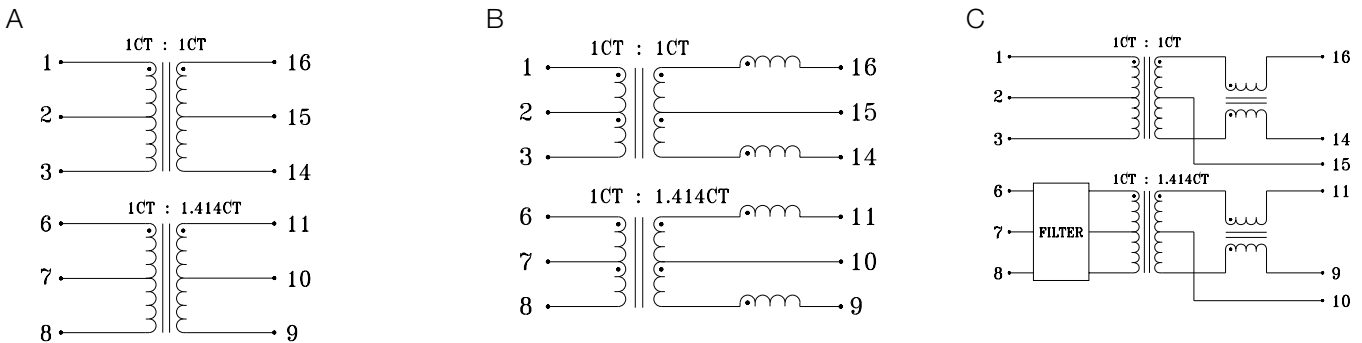

## MECHANICALS

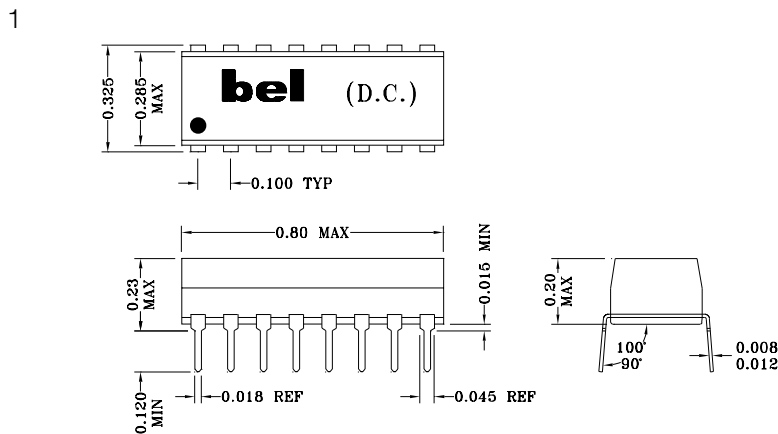

Specifications subject to change without notice.

## 10BASE-T NETWORK COMPONENTS

960051B

### MECHANICALS (CONT'D)

2

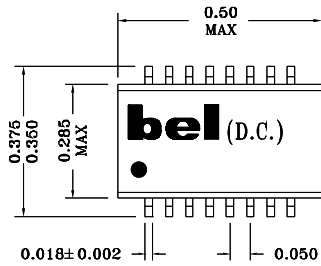

SUGGESTED PCB PAD LAYOUT

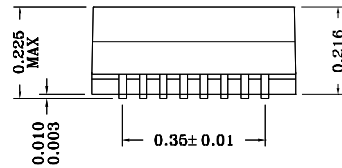
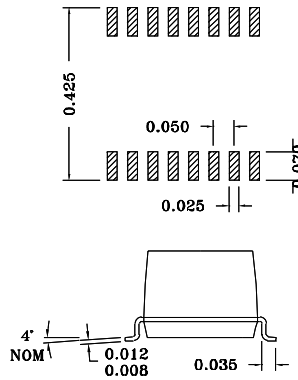

3

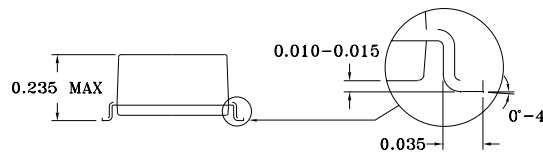
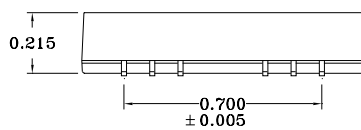
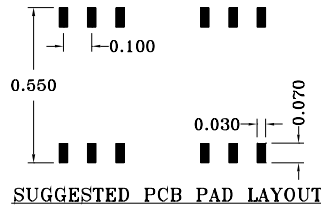
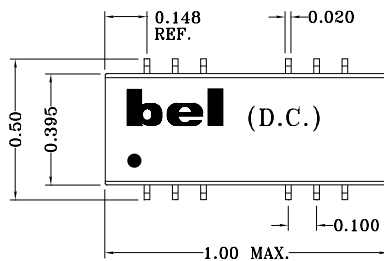

Specifications subject to change without notice.

# 10BASE-T NETWORK COMPONENTS

## APPLICATION CIRCUIT

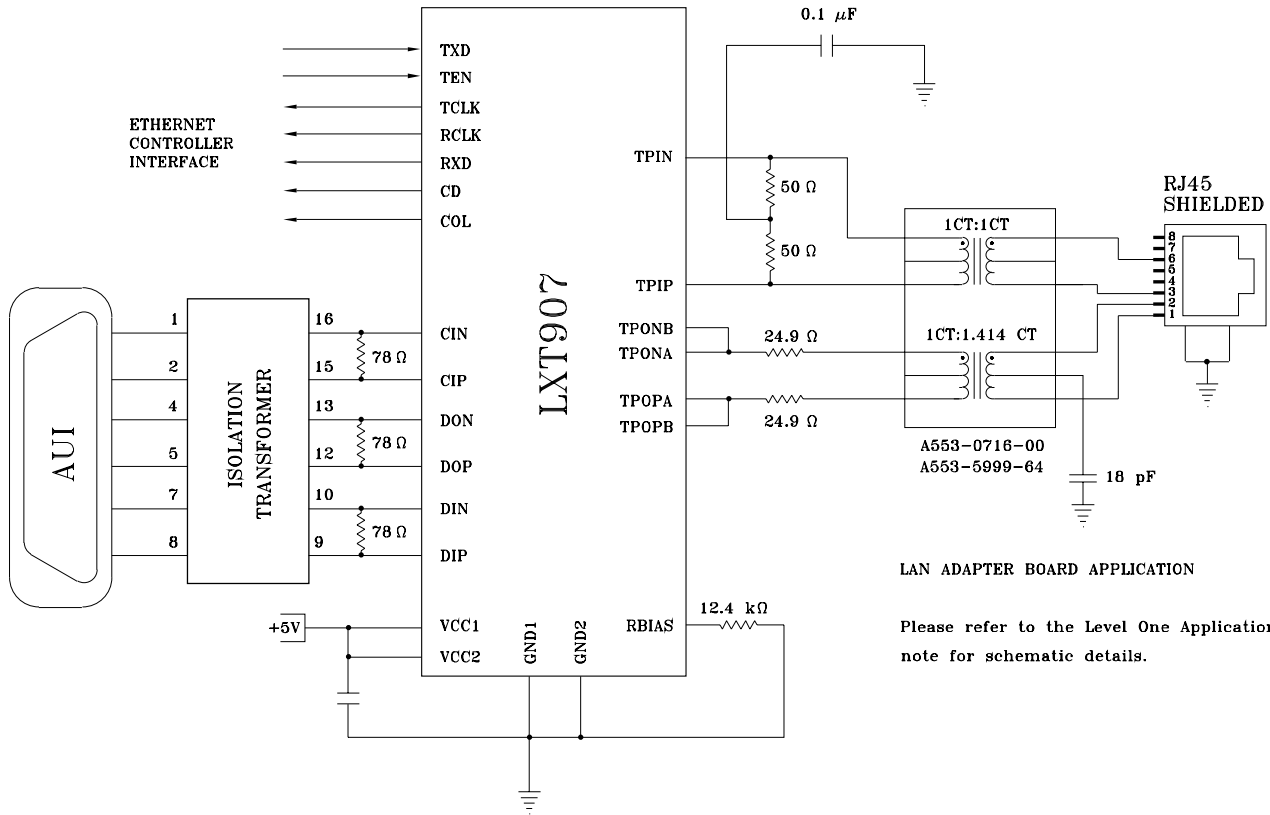

LAN ADAPTER BOARD APPLICATION

Please refer to the Level One Application note for schematic details.

Specifications subject to change without notice.