

S5AB-HF Thru. S5MB-HF

Reverse Voltage: 50 to 1000 Volts

Forward Current: 5.0 Amp

RoHS Device

Halogen Free

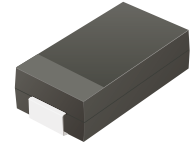

Features

- For surface mounted applications.
- Low profile package.
- Glass passivated chip junction.
- Easy to pick and place.

Mechanical data

- Case: SMB
- Terminals: Solderable per MIL-STD-750, method 2026.

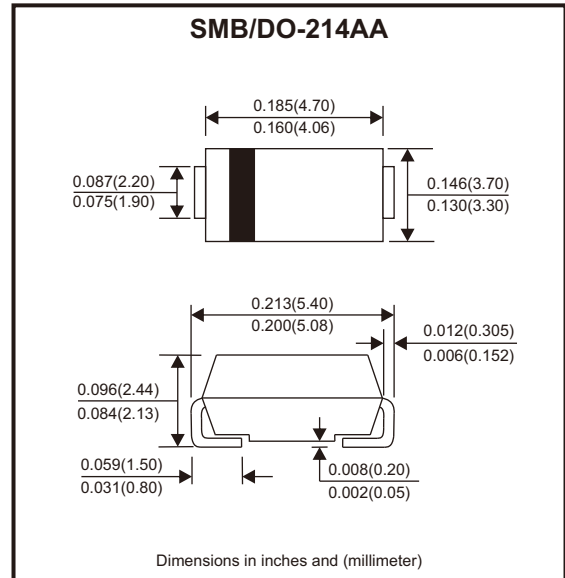

Circuit Diagram



Maximum Ratings and Electrical Characteristics

Ratings at 25°C ambient temperature unless otherwise specified.

Single phase, half wave, 60Hz resistive or inductive load, for capacitive load, derate by 20%

Parameter	Symbols	S5AB-HF	S5BB-HF	S5DB-HF	S5GB-HF	S5JB-HF	S5KB-HF	S5MB-HF	Units
Maximum repetitive peak reverse voltage	V_{RRM}	50	100	200	400	600	800	1000	V
Maximum RMS voltage	V_{RMS}	35	70	140	280	420	560	700	V
Maximum DC blocking voltage	V_{DC}	50	100	200	400	600	800	1000	V
Maximum average forward rectified current	$I_{F(AV)}$	5							A
Peak forward surge current, 8.3ms single half sine-wave superimposed on rated load	I_{FSM}	200							A
Max instantaneous forward voltage at 5A	V_F	1.1							V
Maximum DC reverse current $T_a = 25^\circ\text{C}$ at rated DC blocking voltage $T_a = 125^\circ\text{C}$	I_R	10 100							μA
Typical junction capacitance (Note 1)	C_j	40							pF
Typical thermal resistance (Note 2)	$R_{\theta JA}$ $R_{\theta JC}$	48 16							$^\circ\text{C/W}$
Operating and storage temperature range	T_j, T_{stg}	-55 ~ +150							$^\circ\text{C}$

Notes: 1. Measured at 1 MHz and applied reverse voltage of 4 V D.C

2. P.C.B. mounted with 2.0" X 2.0" (5 X 5 cm) copper pad areas.

Rating and Characteristic Curves (S5AB-HF Thru. S5MB-HF)

Fig.1 - Forward Current Derating Curve

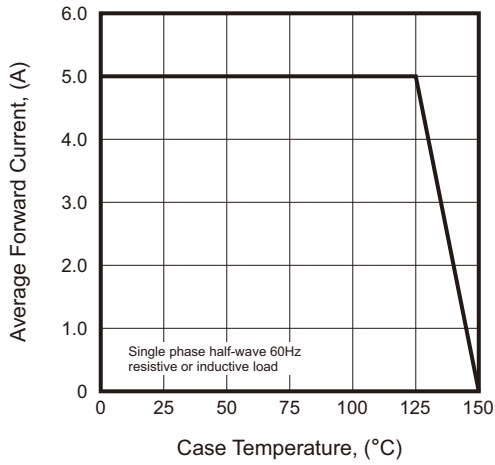

Fig.2 - Typical Instantaneous Reverse Characteristics

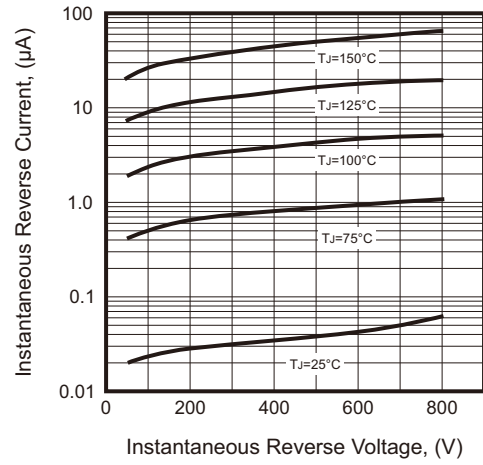

Fig.3 - Typical Forward Characteristic

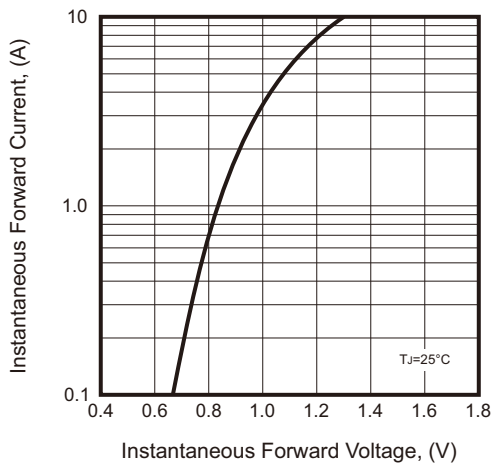

Fig.4 - Typical Junction Capacitance

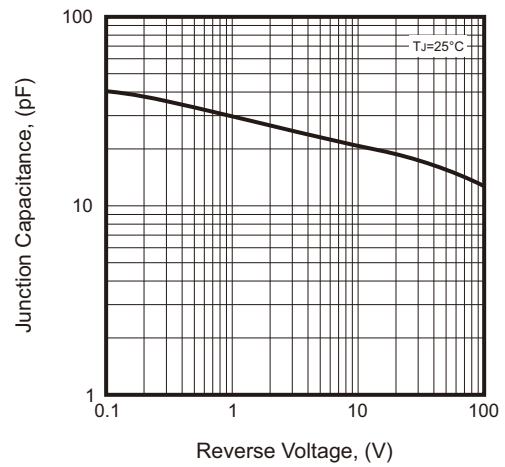
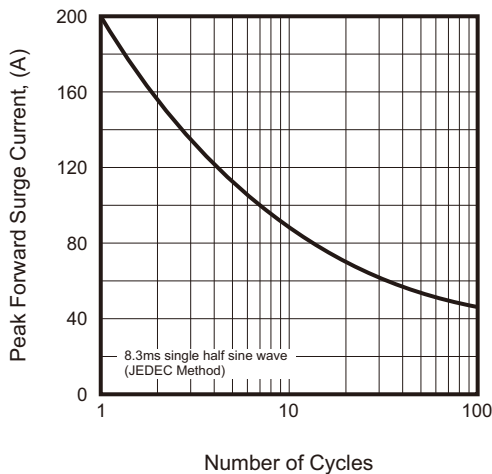
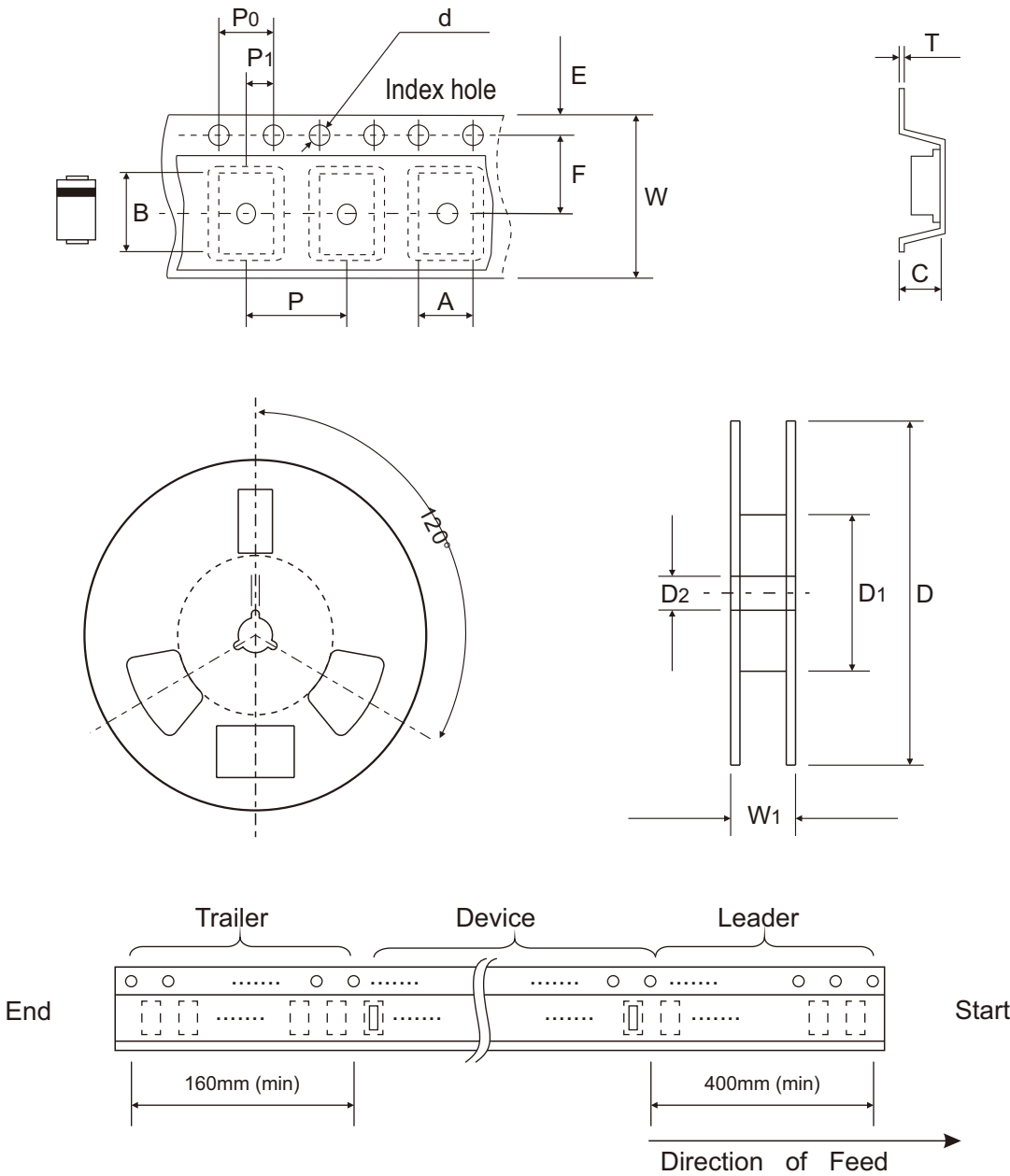

Fig.5 - Maximum Non-Repetitive Peak Forward Surge Current



Reel Taping Specification



DO-214AA (SMB)	SYMBOL	A	B	C	d	D	D1	D2
	(mm)	3.80 ± 0.10	5.50 + 0.05 - 0.10	2.45 ± 0.05	1.55 ± 0.05	330 ± 2.00	100 ± 1.00	13.00 ± 0.20
	(inch)	0.150 ± 0.004	0.217 + 0.002 - 0.004	0.096 ± 0.002	0.061 ± 0.002	12.992 ± 0.079	3.937 ± 0.039	0.512 ± 0.008

DO-214AA (SMB)	SYMBOL	E	F	P	P0	P1	T	W	W1
	(mm)	1.75 ± 0.10	5.50 ± 0.05	8.00 ± 0.10	4.00 ± 0.10	2.00 ± 0.05	0.25 ± 0.05	12.00 ± 0.15	18.00 + 2.00 - 1.00
	(inch)	0.069 ± 0.004	0.217 ± 0.002	0.315 ± 0.004	0.157 ± 0.004	0.079 ± 0.002	0.010 ± 0.002	0.472 ± 0.006	0.709 + 0.079 - 0.039

Company reserves the right to improve product design, functions and reliability without notice.

REV:A