

Main Features

Symbol	Value	Unit
$I_{T(RMS)}$	1.5	A
V_{DRM}/V_{RRM}	400 or 600	V
I_{GT}	200	μ A

Applications

The Sx02xS EV series is specifically designed for solenoid drive often seen in GFCI and similar safety cut-off devices.

Description

This new 1.5A sensitive gate SCR component series offers high static dv/dt and low turn-off time (t_q) through its small die planar construction design. All SCR junctions are glass-passivated to ensure long term reliability and parametric stability.

Features

- Surge capability > 15Amps
- Blocking voltage (V_{DRM}/V_{RRM}) capability — up to 600V
- High dv/dt noise immunity
- Improved turn-off time (t_q) < 35 μ sec.
- Sensitive gate for direct microprocessor interface
- Thru hole and surface mount packages
- RoHS compliant and Halogen-Free

Schematic Symbol

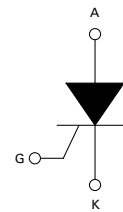

Absolute Maximum Ratings

Symbol	Parameter	Value	Unit
$I_{T(RMS)}$	RMS on-state current (full sine wave)	TO-92 $T_c = 65^\circ\text{C}$	1.5 A
		SOT-89 $T_c = 80^\circ\text{C}$	
		SOT-223 $T_c = 95^\circ\text{C}$	
$I_{T(AV)}$	Average on-state current	TO-92 $T_c = 65^\circ\text{C}$	0.95 A
		SOT-89 $T_c = 80^\circ\text{C}$	
		SOT-223 $T_c = 95^\circ\text{C}$	
I_{TSM}	Non repetitive surge peak on-state current (Single cycle, T_j initial = 25°C)	TO-92 $F = 50$ Hz	12.5 A
		SOT-89 $F = 60$ Hz	
I^2t	I^2t Value for fusing	$t_p = 10$ ms $F = 50$ Hz	0.78 A^2s
		$t_p = 8.3$ ms $F = 60$ Hz	
di/dt	Critical rate of rise of on-state current $I_G = 10\text{mA}$	TO-92 $T_j = 125^\circ\text{C}$ SOT-89 SOT-223	50 $\text{A}/\mu\text{s}$
I_{GM}	Peak gate current	$t_p = 10$ μs $T_j = 125^\circ\text{C}$	1.0 A
$P_{G(AV)}$	Average gate power dissipation	$T_j = 125^\circ\text{C}$	0.1 W
T_{stg}	Storage junction temperature range		-40 to 150 $^\circ\text{C}$
T_j	Operating junction temperature range		-40 to 125 $^\circ\text{C}$

Electrical Characteristics ($T_J = 25^\circ\text{C}$, unless otherwise specified)

Symbol	Description	Test Conditions	Sx02xS		Sx02xS1		Unit
			Min	Max	Min	Max	
I_{GT}	DC Gate Trigger Current	$V_D = 12\text{V}; R_L = 60\ \Omega$	15	200	15	100	μA
V_{GT}	DC Gate Trigger Voltage	$V_D = 12\text{V}; R_L = 60\ \Omega$	—	0.8	—	0.8	V
V_{GRM}	Peak Reverse Gate Voltage	$I_{RG} = 10\ \mu\text{A}$	5	—	5	—	V
I_H	Holding Current	$R_{GK} = 1\ \text{k}\Omega$	—	5	—	3	mA
(dv/dt)s	Critical Rate-of-Rise of Off-State Voltage	$T_J = 125^\circ\text{C}$ $V_D = V_{DRM} / V_{RRM}$ Exponential Waveform $R_{GK} = 1\ \text{k}\Omega$	25	—	25	—	V/ μs
t_q	Turn-Off Time	$T_J = 125^\circ\text{C} @ 600\ \text{V}$ $R_{GK} = 1\ \text{k}\Omega$	—	35	—	35	μs
t_{gt}	Turn-On Time	$I_G = 10\ \text{mA}$ PW = 15 μsec $I_T = 3.0\ \text{A (pk)}$	—	3	—	3	μs
V_{GD}	Gate Non-Trigger Voltage	VD=VDRM, TJ=125°C, RL=3.3K Ω	0.2	-	0.2	-	V

x0 = voltage/10

Static Characteristics ($T_J = 25^\circ\text{C}$, unless otherwise specified)

Symbol	Description	Test Conditions	Value		Unit
			Min	Max	
V_{TM}	Peak On-State Voltage	$I_{TM} = 3.0\ \text{A (pk)}$	—	1.70	V
I_{DRM}	Off-State Current, Peak Repetitive	$T_J = 25^\circ\text{C} @ V_D = V_{DRM}$ $R_{GK} = 1\ \text{k}\Omega$	—	5	μA
		$T_J = 125^\circ\text{C} @ V_D = V_{DRM}$ $R_{GK} = 1\ \text{k}\Omega$	—	500	μA

Thermal Resistances

Symbol	Parameter		Value	Unit	
$R_{\theta(J-C)}$	Junction to case (AC)	$I_T = 1.5\ \text{A}_{(RMS)}^1$	TO-92	50	$^\circ\text{C/W}$
			SOT-89	35	
			SOT-223	25	
$R_{\theta(J-A)}$	Junction to ambient	$I_T = 1.5\ \text{A}_{(RMS)}^1$	TO-92	160	$^\circ\text{C/W}$
			SOT-89	90	
			SOT-223	60	

¹ 60Hz AC resistive load condition, 100% conduction.

Additional Information



Datasheet



Resources



Samples

Figure 1: Normalized DC Gate Trigger Current vs. Junction Temperature

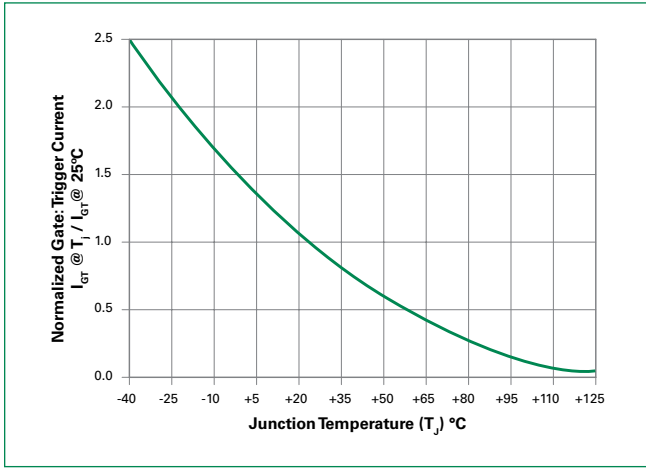

Figure 2: Normalized DC Holding Current vs. Junction Temperature

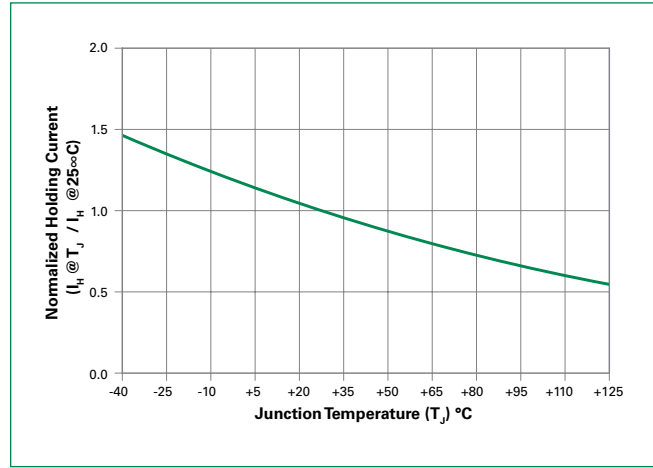

Figure 3: Normalized DC Gate Trigger Voltage vs. Junction Temperature

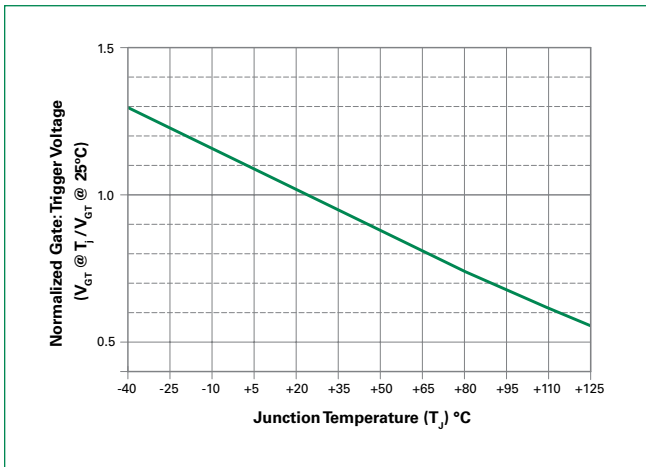

Figure 4: On-State Current vs. On-State Voltage (Typical)

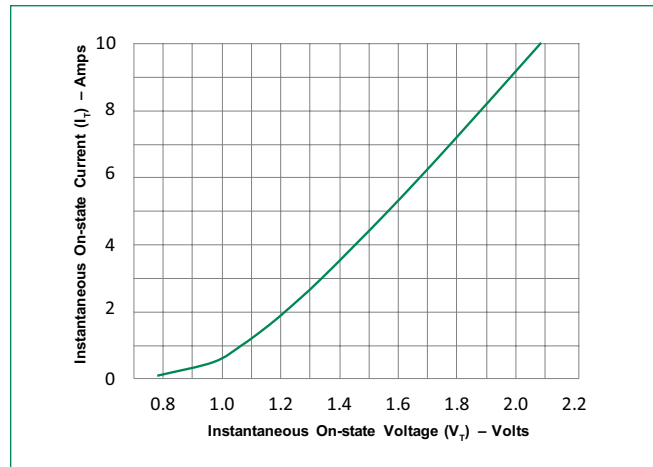

Figure 5: Power Dissipation (Typical) vs. RMS On-State Current

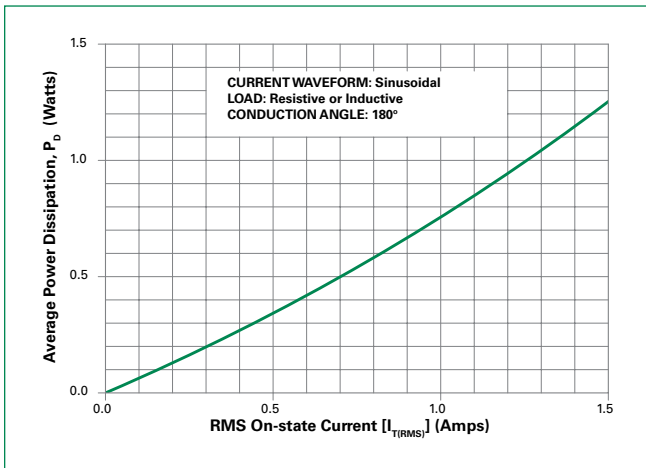

Figure 6: Maximum Allowable Case Temperature vs. On-State Current

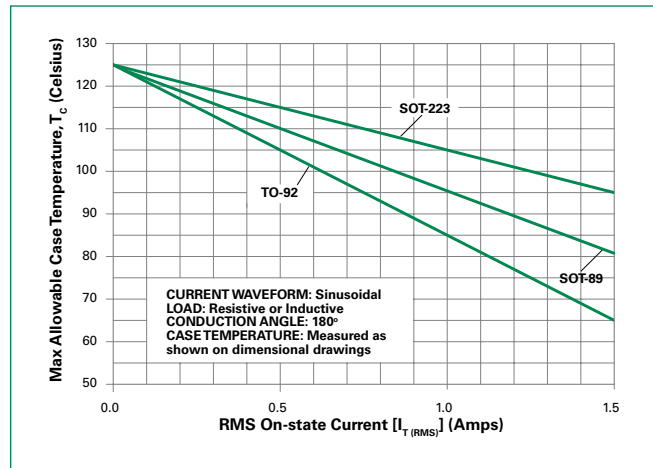

Figure 7: Typical DC Gate Trigger Current with R_{GK} vs. Junction Temperature for Sx02xS

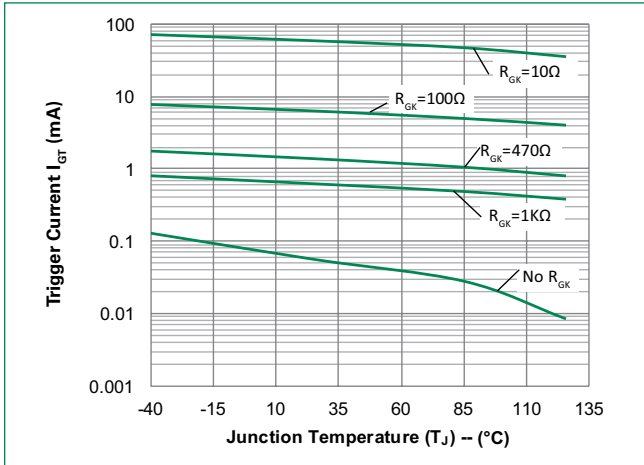

Figure 8: Typical DC Holding Current with R_{GK} vs. Junction Temperature for Sx02xS

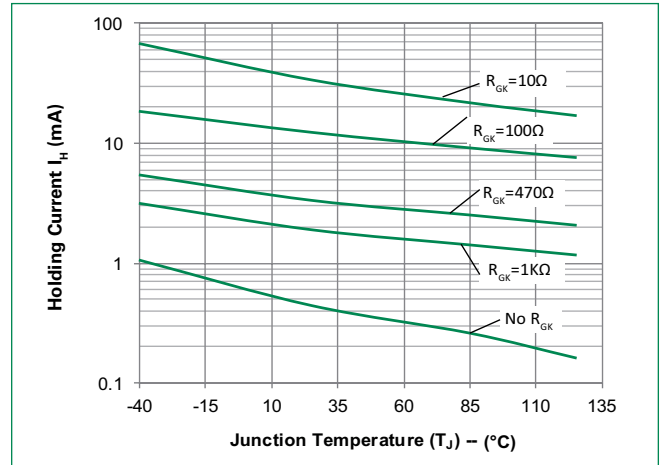

Figure 9: Typical Static dv/dt with R_{GK} vs. Junction Temperature for Sx02xS

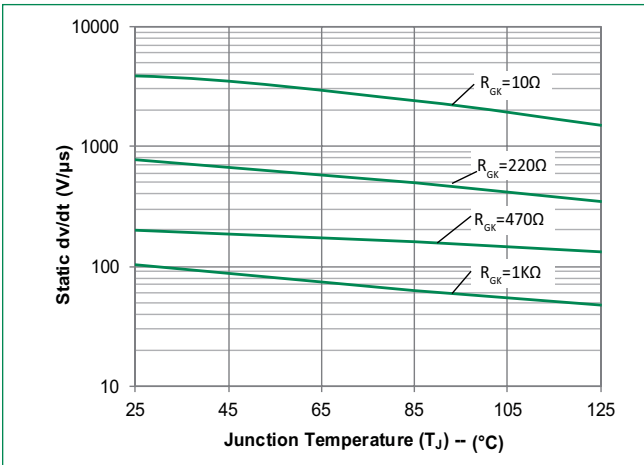

Figure 10: Typical turn off time with R_{GK} vs. Junction Temperature for Sx02xS

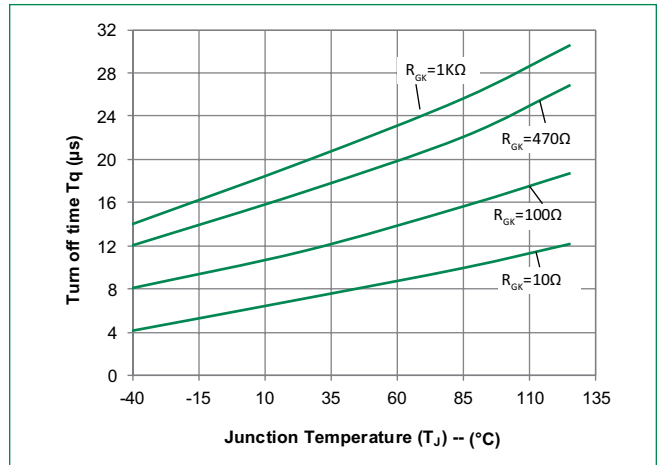
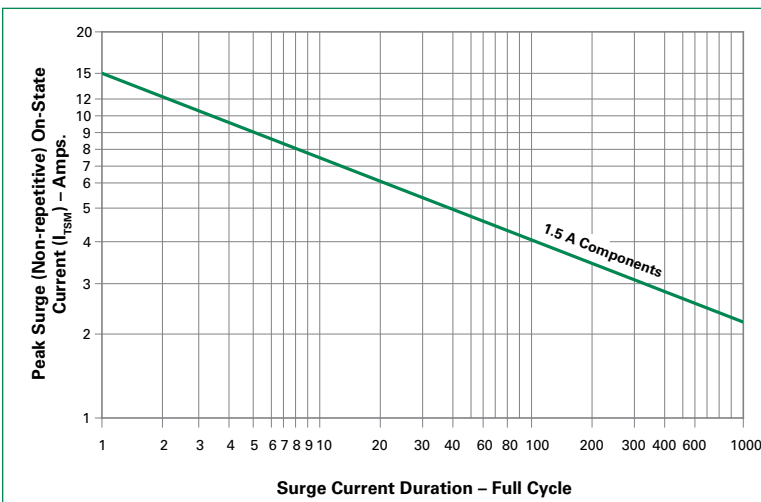

Figure 11: Surge Peak On-State Current vs. Number of Cycles



Supply Frequency: 60Hz Sinusoidal
Load: Resistive
RMS On-State Current (I_{TRMS}): Max Rated Value at Specific Case Temperature

- Notes:
1. Gate control may be lost during and immediately following surge current interval.
 2. Overload may not be repeated until junction temperature has returned to steady-state rated value.

Soldering Parameters

Reflow Condition		Pb – Free assembly
Pre Heat	- Temperature Min ($T_{s(min)}$)	150°C
	- Temperature Max ($T_{s(max)}$)	200°C
	- Time (min to max) (t_s)	60 – 180 secs
Average ramp up rate (Liquidus Temp) (T_L) to peak		5°C/second max
$T_{S(max)}$ to T_L - Ramp-up Rate		5°C/second max
Reflow	- Temperature (T_L) (Liquidus)	217°C
	- Time (min to max) (t_s)	60 – 150 seconds
Peak Temperature (T_p)		260 ^{+0/-5} °C
Time within 5°C of actual peak Temperature (t_p)		20 – 40 seconds
Ramp-down Rate		5°C/second max
Time 25°C to peak Temperature (T_p)		8 minutes Max.
Do not exceed		280°C

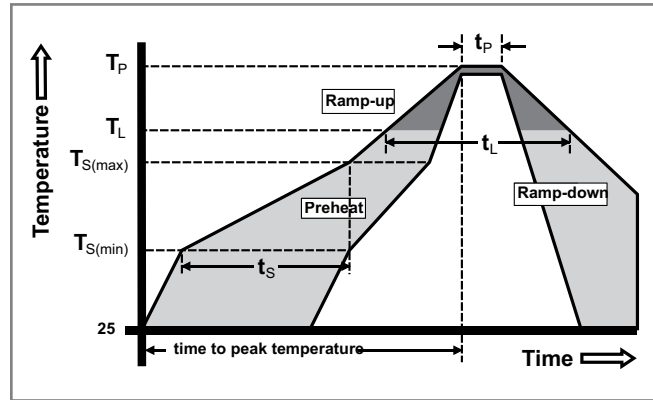

Physical Specifications

Terminal Finish	100% Matte Tin-plated.
Body Material	UL Recognized compound meeting flammability rating V-0
Lead Material	Copper Alloy

Design Considerations

Careful selection of the correct component for the application's operating parameters and environment will go a long way toward extending the operating life of the Thyristor. Good design practice should limit the maximum continuous current through the main terminals to 75% of the component rating. Other ways to ensure long life for a power discrete semiconductor are proper heat sinking and selection of voltage ratings for worst case conditions. Overheating, overvoltage (including dv/dt), and surge currents are the main killers of semiconductors. Correct mounting, soldering, and forming of the leads also help protect against component damage.

Environmental Specifications

Test	Specifications and Conditions
AC Blocking	MIL-STD-750, M-1040, Cond A Applied Peak AC voltage @ 125°C for 1008 hours
Temperature Cycling	MIL-STD-750, M-1051, 100 cycles; -40°C to +150°C; 15-min dwell-time
Temperature/Humidity	EIA / JEDEC, JESD22-A101 1008 hours; 160V - DC: 85°C; 85% rel humidity
High Temp Storage	MIL-STD-750, M-1031, 1008 hours; 150°C
Low-Temp Storage	1008 hours; -40°C
Resistance to Solder Heat	MIL-STD-750 Method 2031
Solderability	ANSI/J-STD-002, category 3, Test A
Lead Bend	MIL-STD-750, M-2036 Cond E

Dimensions — TO-92 (E Package)

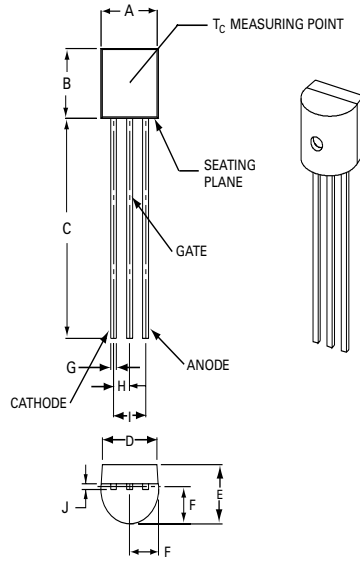

Dimensions	Inches		Millimeters	
	Min	Max	Min	Max
A	0.175	0.205	4.450	5.200
B	0.170	0.210	4.320	5.330
C	0.500	—	12.700	—
D	0.135	—	3.430	—
E	0.125	0.165	3.180	4.190
F	0.080	0.105	2.040	2.660
G	0.016	0.021	0.407	0.533
H	0.045	0.055	1.150	1.390
I	0.095	0.105	2.420	2.660
J	0.015	0.020	0.380	0.500

Dimensions – SOT-223

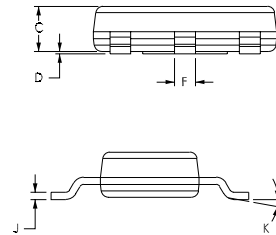
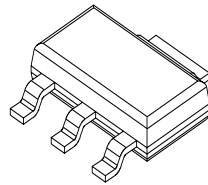
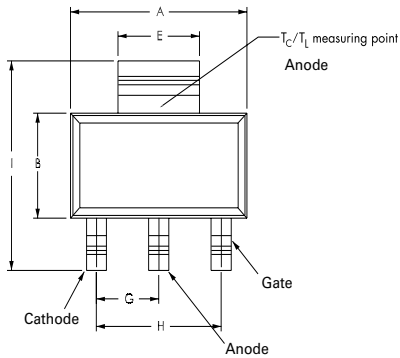

Pad Layout for SOT-223

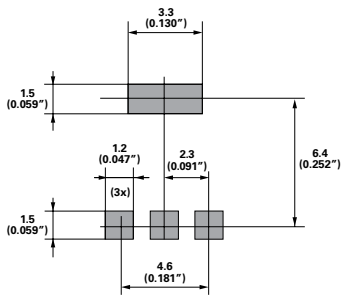

Dimensions in Millimeters (Inches)

Dimensions	Inches			Millimeters		
	Min	Typ	Max	Min	Typ	Max
A	0.248	0.256	0.264	6.30	6.50	6.70
B	0.130	0.138	0.146	3.30	3.50	3.70
C	—	—	0.071	—	—	1.80
D	0.001	—	0.004	0.02	—	0.10
E	0.114	0.118	0.124	2.90	3.00	3.15
F	0.024	0.027	0.034	0.60	0.70	0.85
G	—	0.090	—	—	2.30	—
H	—	0.181	—	—	4.60	—
I	0.264	0.276	0.287	6.70	7.00	7.30
J	0.009	0.010	0.014	0.24	0.26	0.35
K	10° MAX					

Dimensions – SOT-89

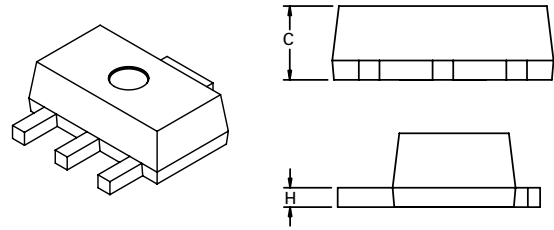
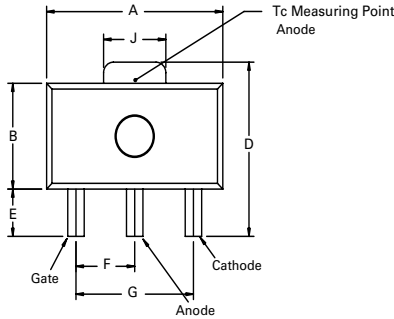

Pad Layout for SOT-89

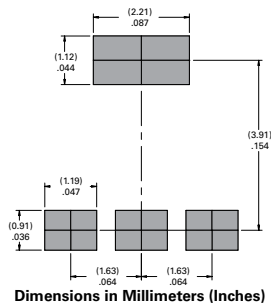

Dimension	Inches			Millimeters		
	Min	Typ	Max	Min	Typ	Max
A	0.173	—	0.181	4.40	—	4.60
B	0.090	—	0.102	2.29	—	2.60
C	0.055	—	0.063	1.40	—	1.60
D	0.155	—	0.167	3.94	—	4.25
E	0.035	—	0.047	0.89	—	1.20
F	0.056	—	0.062	1.42	—	1.57
G	0.115	—	0.121	2.92	—	3.07
H	0.014	—	0.017	0.35	—	0.44
I	0.014	—	0.019	0.36	—	0.48
J	0.064	—	0.072	1.62	—	1.83

Product Selector

Part Number	Voltage		Gate Sensitivity	Package
	400V	600V		
S402ES	X	—	200µA	TO-92
S602ES	—	X	200µA	TO-92
S402TS	X	—	200µA	SOT-223
S602TS	—	X	200µA	SOT-223
Sx02ES1	X	X	100µA	TO-92
Sx02BS1	X	X	100µA	SOT-89
Sx02BS	X	X	200µA	SOT-89
Sx02TS1	X	X	100µA	SOT-223

Note: x = voltage/100

Packing Options

Part Number	Marking	Weight	Packing Mode	Base Quantity
Sx02ES	Sx02ES	0.217 g	Bulk	2500
Sx02ESAP	Sx02ES	0.217 g	Ammo Pack	2000
Sx02ESRP	Sx02ES	0.217 g	Tape & Reel	2000
Sx02TSRP	Sx02TS	0.120 g	Tape & Reel	1000
Sx02ES1	Sx02ES	0.217 g	Bulk	2500
Sx02ES1AP	Sx02ES1	0.217 g	Ammo Pack	2000
Sx02ES1RP	Sx02ES1	0.217 g	Tape & Reel	2000
Sx02TS1RP	Sx02TS1	0.120 g	Tape & Reel	1000
Sx02BSRP	Sx02BS	0.053 g	Tape & Reel	1000
Sx02BS1RP	Sx02BS1	0.053 g	Tape & Reel	1000

TO-92 (3-lead) Reel Pack (RP) Radial Leaded Specifications

Meets all EIA-468-C Standards

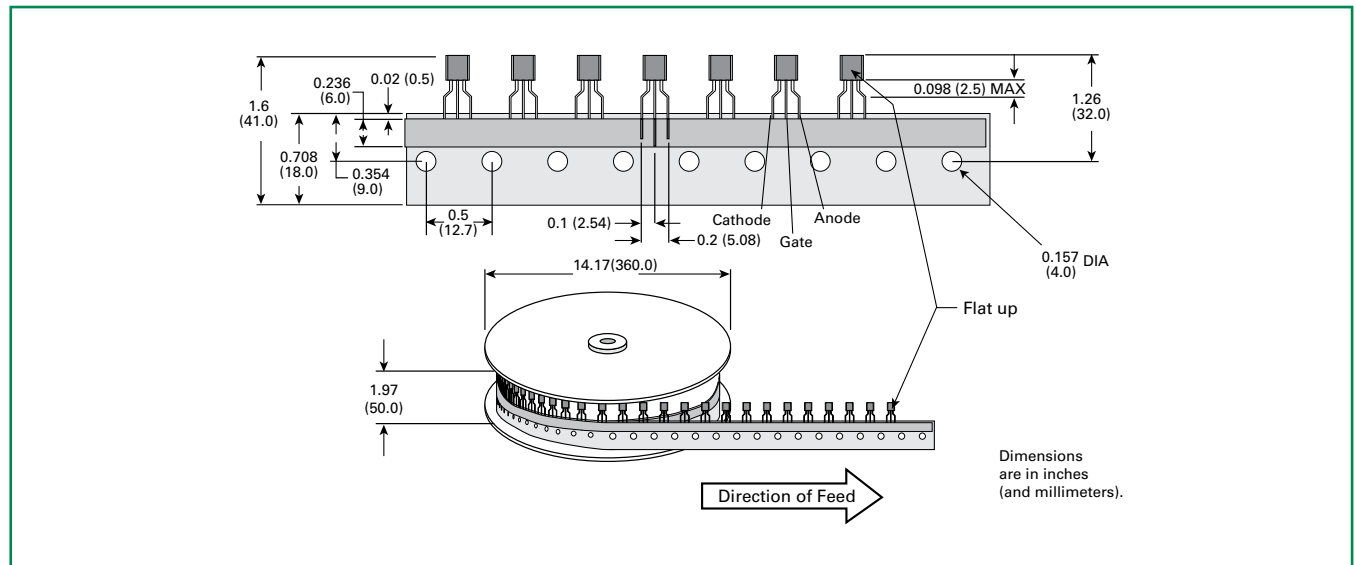

TO-92 (3-lead) Ammo Pack (AP) Radial Leaded Specifications

Meets all EIA-468-C Standards

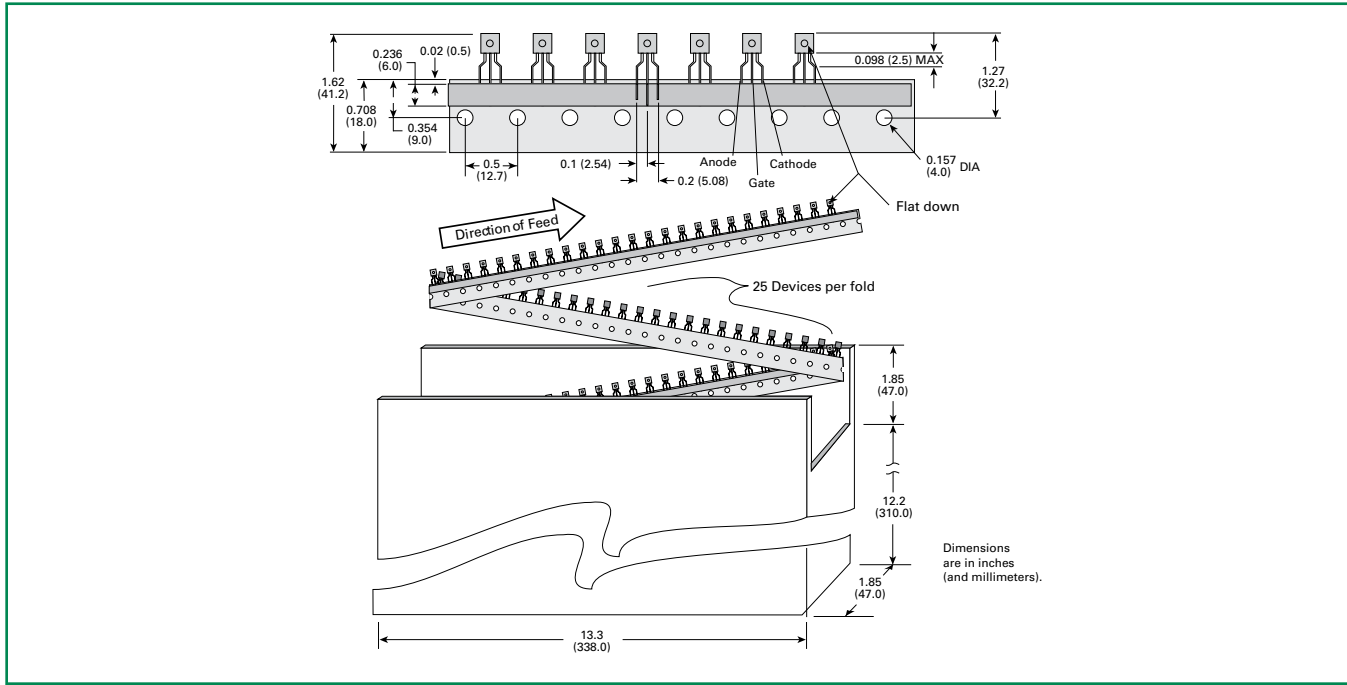

SOT-223 Reel Pack (RP) Specifications

