

Sx02xSx EV Series

EV Series 1.5 Amp Sensitive SCRs

HF RoHS

Additional Information

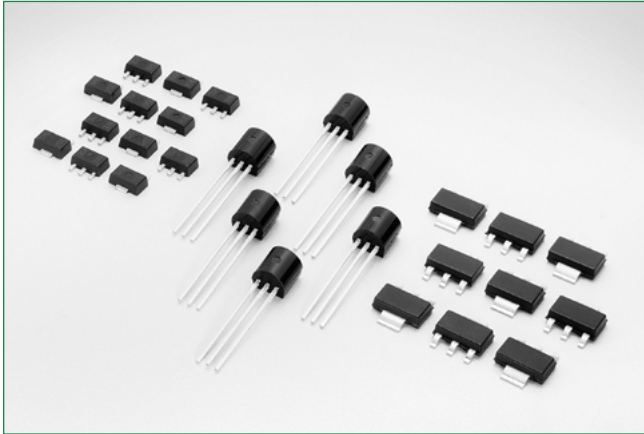

Resources



Accessories



Samples

Main Features

Symbol	Value	Unit
$I_{T(RMS)}$	1.5	A
V_{DRM}/V_{RRM}	400 or 600	V
I_{GT}	200	μ A

Description

This new 1.5A sensitive gate SCR component series offers high static dv/dt and low turn-off time (tq) All SCR junctions are glass-passivated to ensure long term reliability and parametric stability.

Features

- Surge capability > 15Amps
- Blocking voltage (VDRM/VRRM) capability — up to 600V
- High dv/dt noise immunity
- Improved turn-off time (tq) < 35 μ sec.
- Sensitive gate for direct microprocessor interface
- Thru hole and surface mount packages
- RoHS compliant and Halogen-Free

Applications

The Sx02xSx EV series is specifically designed for solenoid drive often seen in GFCI and similar safety cut-off devices.

Schematic Symbol

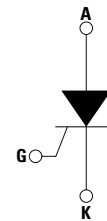

Absolute Maximum Ratings

Symbol	Parameter	Value	Unit	
$I_{T(RMS)}$	RMS on-state current (full sine wave)	TO-92 $T_c = 65^\circ\text{C}$	1.5	A
		SOT-89 $T_c = 80^\circ\text{C}$		
		SOT-223 $T_c = 95^\circ\text{C}$		
$I_{T(AV)}$	Average on-state current	TO-92 $T_c = 65^\circ\text{C}$	0.95	A
		SOT-89 $T_c = 80^\circ\text{C}$		
		SOT-223 $T_c = 95^\circ\text{C}$		
I_{TSM}	Non repetitive surge peak on-state current (Single cycle, T_j initial = 25°C)	TO-92 $F = 50$ Hz	12.5	A
		SOT-89 $F = 60$ Hz	15.0	
		SOT-223		
I^2t	I^2t Value for fusing	$t_p = 10$ ms $F = 50$ Hz	0.78	A^2s
		$t_p = 8.3$ ms $F = 60$ Hz	0.93	
di/dt	Critical rate of rise of on-state current $I_G = 10\text{mA}$	TO-92 $T_j = 125^\circ\text{C}$ SOT-89 $T_j = 125^\circ\text{C}$ SOT-223	50	$\text{A}/\mu\text{s}$
I_{GM}	Peak gate current	$t_p = 10$ μs $T_j = 125^\circ\text{C}$	1.0	A
$P_{G(AV)}$	Average gate power dissipation	$T_j = 125^\circ\text{C}$	0.1	W
T_{stg}	Storage junction temperature range		-40 to 150	$^\circ\text{C}$
T_j	Operating junction temperature range		-40 to 125	$^\circ\text{C}$

Sx02xSx EV Series

EV Series 1.5 Amp Sensitive SCRs

Electrical Characteristics (T_J = 25°C, unless otherwise specified)

Symbol	Description	Test Conditions	Sx02xS		Sx02xS1		Sx02xS2		Units
			Min	Max	Min	Max	Min	Max	
I _{GT}	DC Gate Trigger Current	V _D = 12V; R _L = 60 Ω	15	200	15	100	15	50	μA
V _{GT}	DC Gate Trigger Voltage	V _D = 12V; R _L = 60 Ω	—	0.8	—	0.8	—	0.8	V
V _{GRRM}	Peak Reverse Gate Voltage	I _{RG} = 10μA	5	—	5	—	5	—	V
I _H	Holding Current	R _{GK} = 1 kΩ	—	5	—	3	—	3	mA
(dv/dt) _s	"Critical Rate-of-Rise of Off-State Voltage"	"T _J = 125°C V _D = V _{DRM} / V _{RPM} Exponential Waveform R _{GK} = 1 kΩ"	25	—	25	—	25	—	V/μs
t _q	Turn-Off Time	"T _J = 125°C @ 600 V R _{GK} = 1 kΩ"	—	35	—	35	—	35	μs
t _{gt}	Turn-On Time	"I _G = 10mA PW = 15μsec I _T = 3.0A (pk)"	—	3	—	3	—	3	μs
V _{GD}	Gate Non-Trigger Voltage	"V _D = V _{DRM} , T _J = 125°C, R _L = 3.3kΩ"	0.2	—	0.2	—	0.2	—	V

x0 = voltage/10

Static Characteristics (T_J = 25°C, unless otherwise specified)

Symbol	Description	Test Conditions	Value		Unit
			Min	Max	
V _{TM}	Peak On-State Voltage	I _{TM} = 3.0A (pk)	—	1.70	V
I _{DRM}	Off-State Current, Peak Repetitive	T _J = 25°C @ V _D = V _{DRM} R _{GK} = 1 kΩ	—	5	μA
		T _J = 125°C @ V _D = V _{DRM} R _{GK} = 1 kΩ	—	500	μA

Thermal Resistances

Symbol	Parameter	Test Conditions	Value	Unit	
R _{θ(J-C)}	Junction to case (AC)	I _T = 1.5A _(RMS) ¹	TO-92	50	°C/W
			SOT-89	35	
			SOT-223	25	
R _{θ(J-A)}	Junction to ambient	I _T = 1.5A _(RMS) ¹	TO-92	160	°C/W
			SOT-89	90	
			SOT-223	60	

¹ 60Hz AC resistive load condition, 100% conduction.

Sx02xSx EV Series

EV Series 1.5 Amp Sensitive SCRs

Figure 1: Normalized DC Gate Trigger Current vs. Junction Temperature

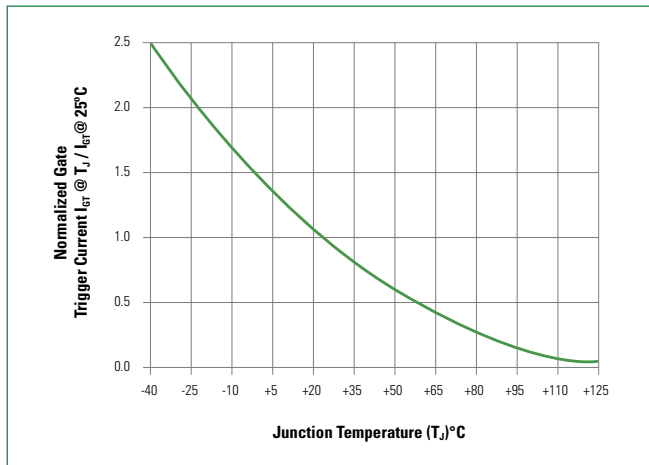

Figure 2: Normalized DC Holding Current vs. Junction Temperature

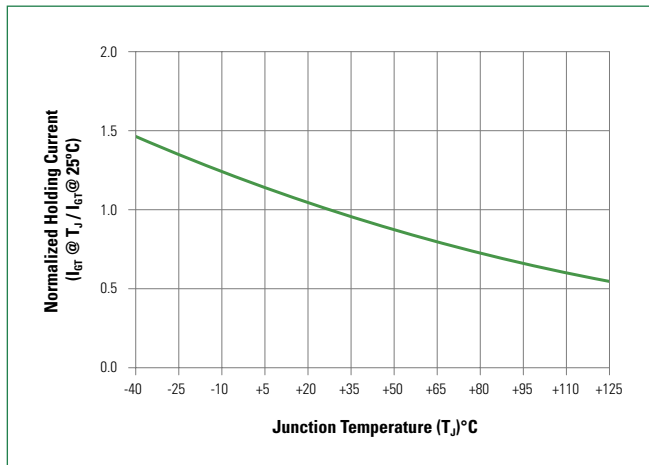

Figure 3: Normalized DC Gate Trigger Voltage vs. Junction Temperature

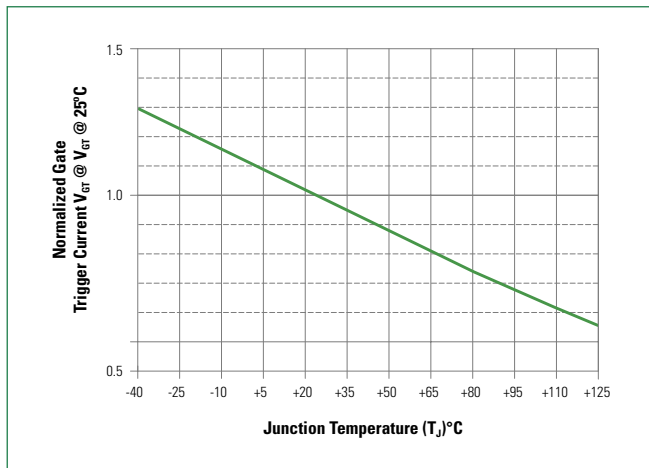

Figure 4: On-State Current vs. On-State Voltage (Typical)

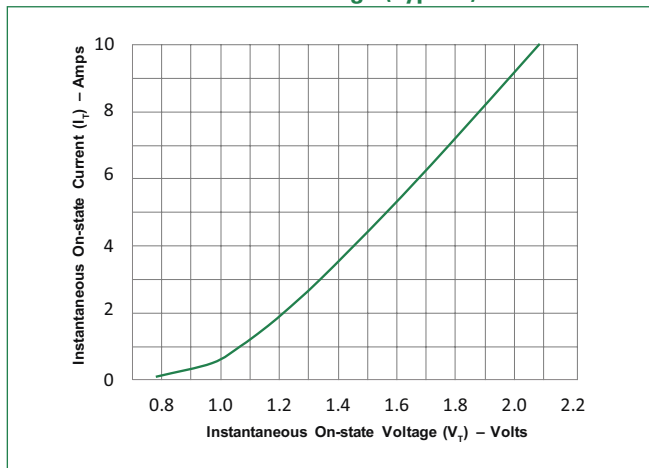

Figure 5: Power Dissipation (Typical) vs. RMS On-State Current

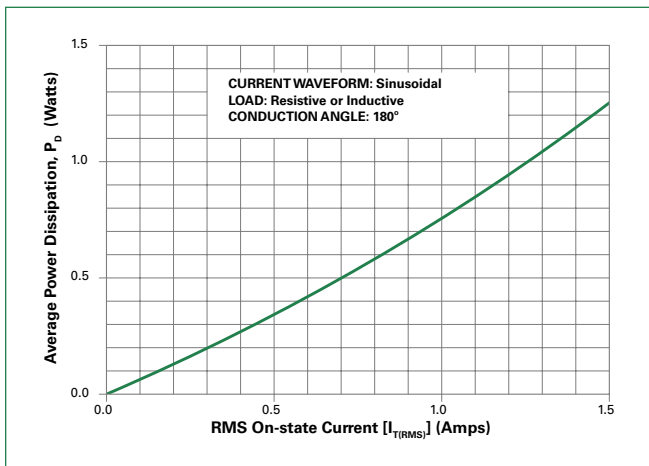
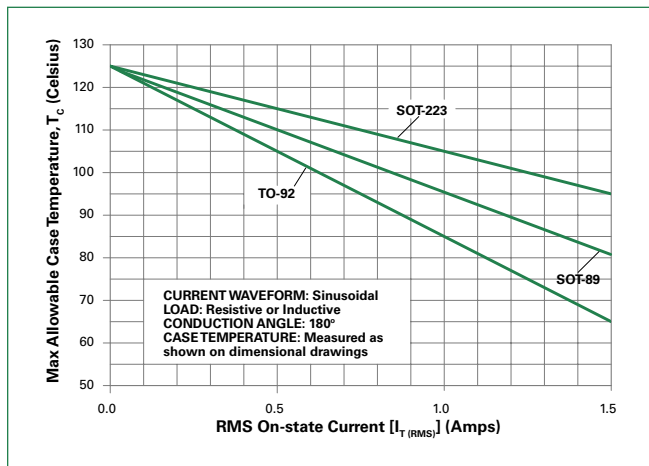

Figure 6: Maximum Allowable Case Temperature vs. On-State Current



Sx02xSx EV Series

EV Series 1.5 Amp Sensitive SCRs

Figure 7: Typical DC Gate Trigger Current with R_{GK} vs. Junction Temperature for Sx02xS

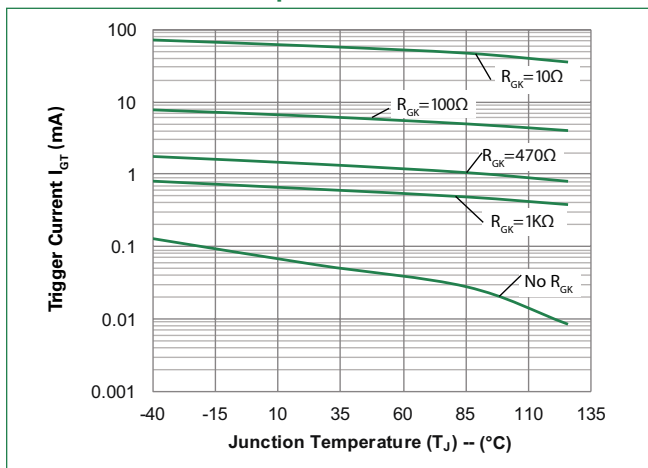

Figure 8: Typical DC Holding Current with R_{GK} vs. Junction Temperature for Sx02xS

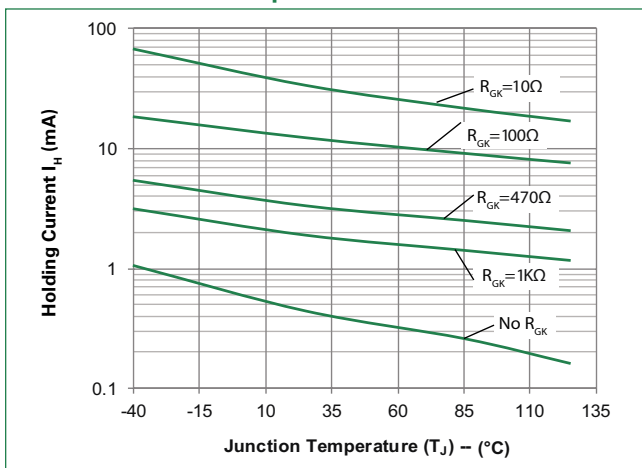

Figure 9: Typical Static dv/dt with R_{GK} vs. Junction Temperature for Sx02xS

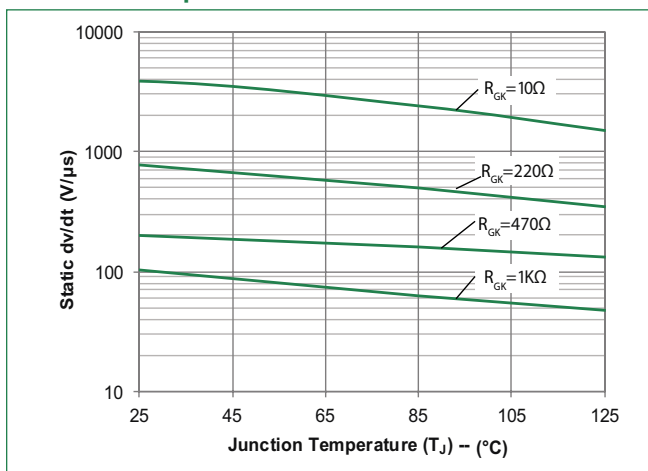

Figure 10: Typical turn off time with R_{GK} vs. Junction Temperature for Sx02xS

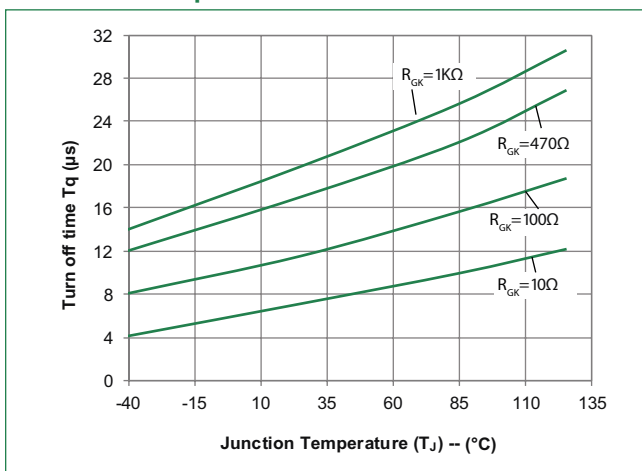
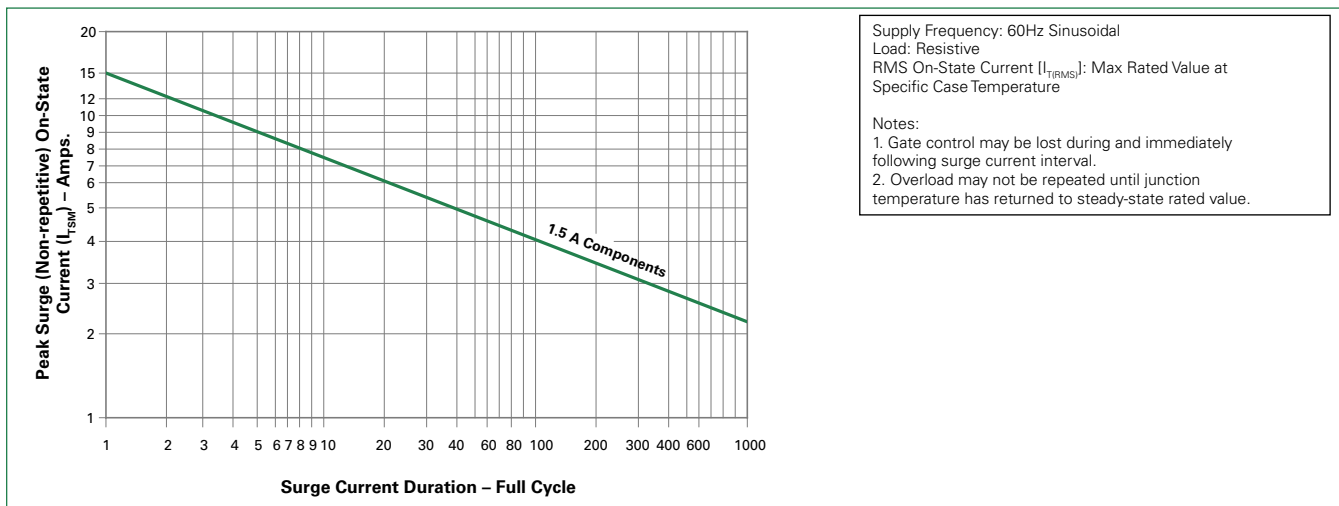

Figure 11: Surge Peak On-State Current vs. Number of Cycles



Sx02xSx EV Series

EV Series 1.5 Amp Sensitive SCRs

Soldering Parameters

Reflow Condition		Pb – Free assembly
Pre Heat	- Temperature Min ($T_{s(min)}$)	150°C
	- Temperature Max ($T_{s(max)}$)	200°C
	- Time (min to max) (t_s)	60 – 180 secs
Average ramp up rate (Liquidus Temp) (T_L) to peak		5°C/second max
$T_{s(max)}$ to T_L - Ramp-up Rate		5°C/second max
Reflow	- Temperature (T_L) (Liquidus)	217°C
	- Time (min to max) (t_s)	60 – 150 seconds
Peak Temperature (T_p)		260 ^{+0/-5} °C
Time within 5°C of actual peak Temperature (t_p)		20 – 40 seconds
Ramp-down Rate		5°C/second max
Time 25°C to peak Temperature (T_p)		8 minutes Max.
Do not exceed		280°C

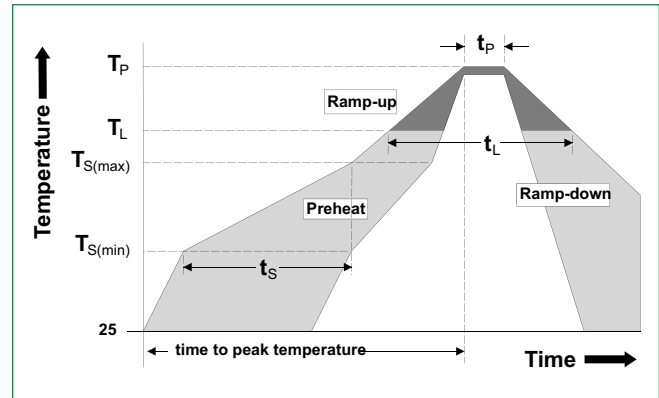

Physical Specifications

Terminal Finish	100% Matte Tin-plated.
Body Material	UL Recognized compound meeting flammability rating V-0
Lead Material	Copper Alloy

Design Considerations

Careful selection of the correct component for the application's operating parameters and environment will go a long way toward extending the operating life of the Thyristor. Good design practice should limit the maximum continuous current through the main terminals to 75% of the component rating. Other ways to ensure long life for a power discrete semiconductor are proper heat sinking and selection of voltage ratings for worst case conditions. Overheating, overvoltage (including dv/dt), and surge currents are the main killers of semiconductors. Correct mounting, soldering, and forming of the leads also help protect against component damage.

Environmental Specifications

Test	Specifications and Conditions
AC Blocking	MIL-STD-750, M-1040, Cond A Applied Peak AC voltage @ 125°C for 1008 hours
Temperature Cycling	MIL-STD-750, M-1051, 100 cycles; -40°C to +150°C; 15-min dwell-time
Temperature/Humidity	EIA / JEDEC, JESD22-A101 1008 hours; 160V - DC; 85°C; 85% rel humidity
Resistance to Solder Heat	MIL-STD-750 Method 2031
Solderability	ANSI/J-STD-002, category 3, Test A
Lead Bend	MIL-STD-750, M-2036 Cond E

Sx02xSx EV Series

EV Series 1.5 Amp Sensitive SCRs

Dimensions – TO-92 (E Package)

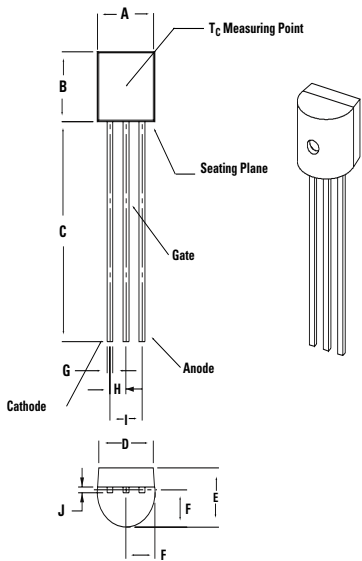

Dimensions	Inches		Millimeters	
	Min	Max	Min	Max
A	0.175	0.205	4.450	5.200
B	0.170	0.210	4.320	5.330
C	0.500	—	12.700	—
D	0.135	—	3.430	—
E	0.125	0.165	3.180	4.190
F	0.080	0.105	2.040	2.660
G	0.016	0.021	0.407	0.533
H	0.045	0.055	1.150	1.390
I	0.095	0.105	2.420	2.660
J	0.015	0.020	0.380	0.500

Dimensions – SOT-223

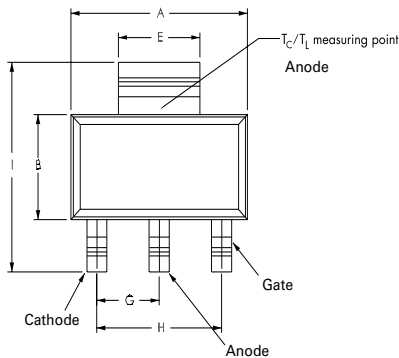

Pad Layout for SOT-223

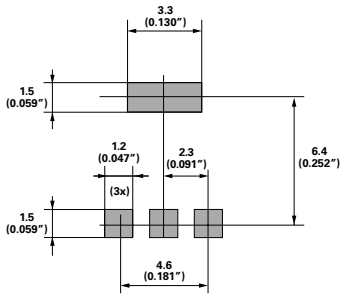

Dimensions in Millimeters (Inches)

Dimensions	Inches			Millimeters		
	Min	Typ	Max	Min	Typ	Max
A	0.248	0.256	0.264	6.30	6.50	6.70
B	0.130	0.138	0.146	3.30	3.50	3.70
C	—	—	0.071	—	—	1.80
D	0.001	—	0.004	0.02	—	0.10
E	0.114	0.118	0.124	2.90	3.00	3.15
F	0.024	0.027	0.034	0.60	0.70	0.85
G	—	0.090	—	—	2.30	—
H	—	0.181	—	—	4.60	—
I	0.264	0.276	0.287	6.70	7.00	7.30
J	0.009	0.010	0.014	0.24	0.26	0.35
K	10° MAX					

Sx02xSx EV Series

EV Series 1.5 Amp Sensitive SCRs

Dimensions – SOT-89

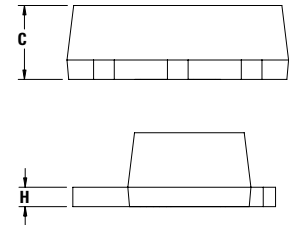
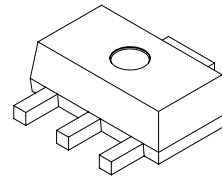
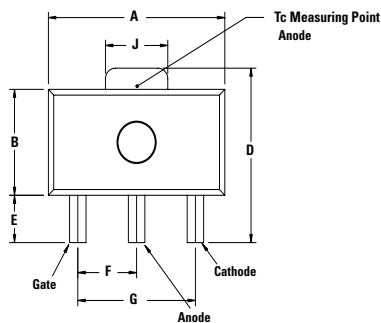

Pad Layout for SOT-89

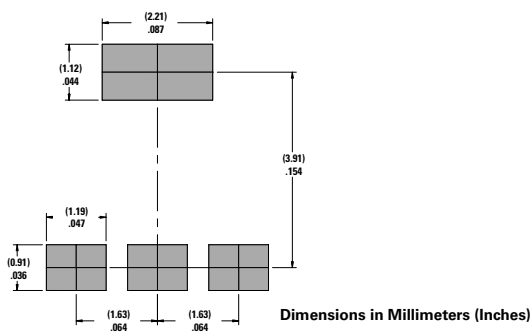

Dimension	Inches			Millimeters		
	Min	Typ	Max	Min	Typ	Max
A	0.173	—	0.181	4.40	—	4.60
B	0.090	—	0.102	2.29	—	2.60
C	0.055	—	0.063	1.40	—	1.60
D	0.155	—	0.167	3.94	—	4.25
E	0.035	—	0.047	0.89	—	1.20
F	0.056	—	0.062	1.42	—	1.57
G	0.115	—	0.121	2.92	—	3.07
H	0.014	—	0.017	0.35	—	0.44
I	0.014	—	0.019	0.36	—	0.48
J	0.064	—	0.072	1.62	—	1.83

Product Selector

Part Numbr	Voltage		Gate Sensitivity	Package
	400V	600V		
Sx02BS	X	X	200 μ A	SOT-89
Sx02ES	X	X	200 μ A	TO-92
Sx02TS	X	X	200 μ A	SOT-223
Sx02BS1	X	X	100 μ A	SOT-89
Sx02ES1	X	X	100 μ A	TO-92
Sx02TS1	X	X	100 μ A	SOT-223
Sx02BS2	—	X	50 μ A	SOT-89

Note: x = voltage/100

Packing Options

Part Number	Marking	Weight	Packing Mode	Base Quantity
Sx02ESy	Sx02ESy	0.217 g	Bulk	2500
Sx02ESyAP	Sx02ESy	0.217 g	Ammo Pack	2000
Sx02ESyRP	Sx02ESy	0.217 g	Tape & Reel	2000
Sx02TSyRP	Sx02TSy	0.120 g	Tape & Reel	1000
Sx02BSyRP	x02y	0.053 g	Tape & Reel	1000
Sx02BSyRP1	x02y	0.053 g	Tape & Reel	1000

Sx02xSx EV Series

EV Series 1.5 Amp Sensitive SCRs

TO-92 (3-lead) Reel Pack (RP) Radial Leaded Specifications

Meets all EIA-468-C Standards

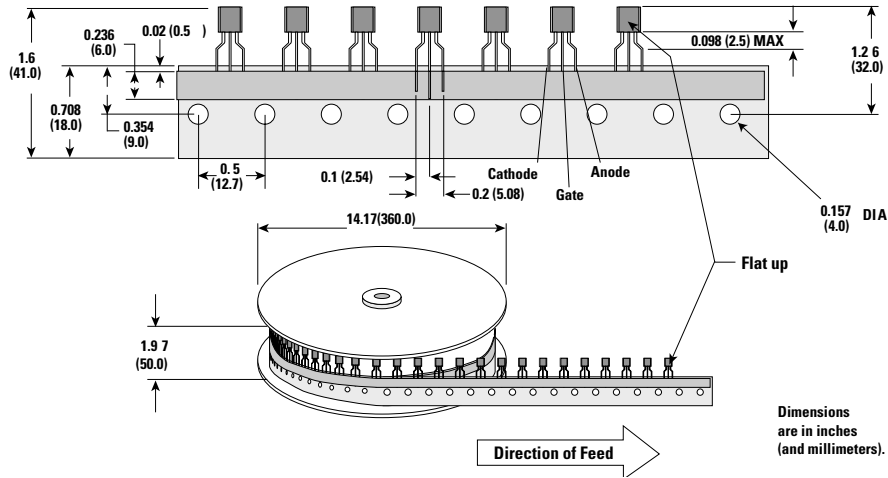

SOT-89 Reel Pack (RP) Specifications

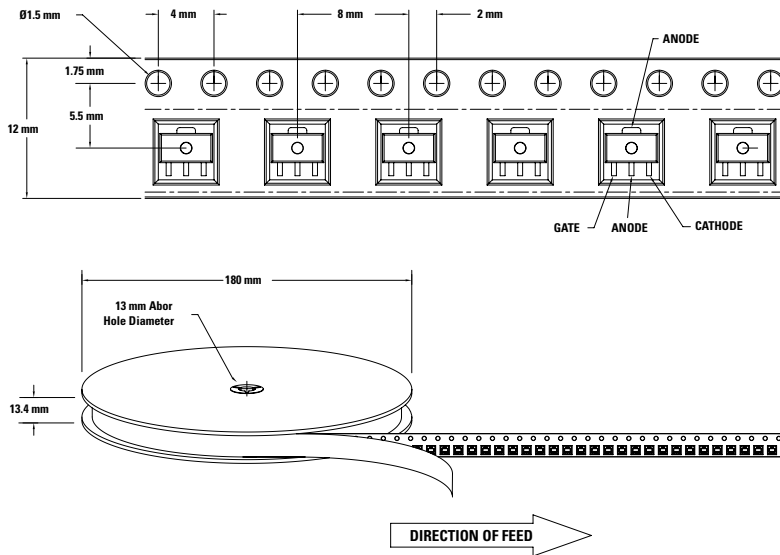

Sx02xSx EV Series

EV Series 1.5 Amp Sensitive SCRs

SOT-89 Reel Pack (RP1) Specifications

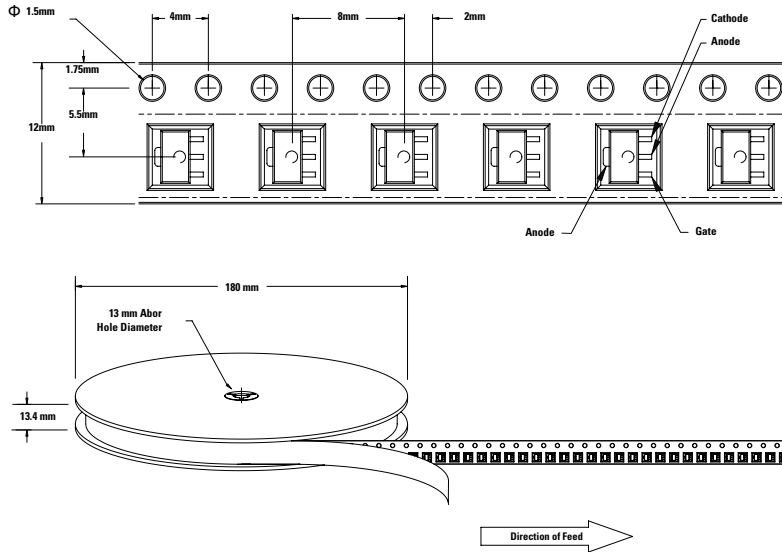

TO-92 (3-lead) Ammo Pack (AP) Radial Leaded Specifications

Meets all EIA-468-C Standards

