

Sxx65x & Sxx70x Series



Description

Excellent unidirectional switches for phase control applications such as heating and motor speed controls. Standard phase control SCRs are triggered with few milliamperes of current at less than 1.5V potential.

Features & Benefits

- RoHS compliant
- Glass – passivated junctions
- Voltage capability up to 1000 V
- Surge capability up to 950 A

Applications

Typical applications are AC solid-state switches, industrial power tools, exercise equipment, white goods and commercial appliances.

Internally constructed isolated packages are offered for ease of heat sinking with highest isolation voltage.

Agency Approval

Agency	Agency File Number
	J & K Packages: E71639

Main Features

Symbol	Value	Unit
$I_{T(RMS)}$	65 & 70	A
V_{DRM}/V_{RRM}	400 to 1000	V
I_{GT}	50	mA

Schematic Symbol

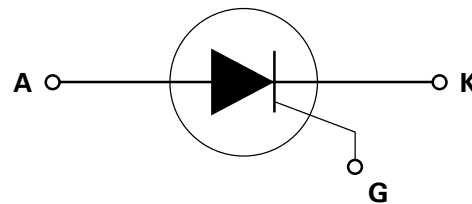

Absolute Maximum Ratings

Symbol	Parameter	Test Conditions		Value	Unit
		Part	Temp		
$I_{T(RMS)}$	RMS on-state current	Sxx65J Sxx65K	$T_c = 75^\circ\text{C}$	65	A
		Sxx70W	$T_c = 80^\circ\text{C}$	70	
$I_{T(AV)}$	Average on-state current	Sxx65J Sxx65K	$T_c = 75^\circ\text{C}$	41.0	A
		Sxx70W	$T_c = 80^\circ\text{C}$	45.0	A
I_{TSM}	Peak non-repetitive surge current	single half cycle; $f = 50\text{Hz}$; T_j (initial) = 25°C		800	A
		single half cycle; $f = 60\text{Hz}$; T_j (initial) = 25°C		950	
I^2t	I^2t Value for fusing	$t_p = 8.3 \text{ ms}$		3745	A^2s
di/dt	Critical rate of rise of on-state current	$f = 60\text{Hz}$; $T_j = 125^\circ\text{C}$		200	$\text{A}/\mu\text{s}$
I_{GM}	Peak gate current	$T_j = 125^\circ\text{C}$ $P_w = 15 \mu\text{S Max}$		5.0	A
$P_{G(AV)}$	Average gate power dissipation	$T_j = 125^\circ\text{C}$		1.0	W
T_{stg}	Storage temperature range			-40 to 150	$^\circ\text{C}$
T_j	Operating junction temperature range			-40 to 125	$^\circ\text{C}$

Electrical Characteristics (T_J = 25°C, unless otherwise specified)

Symbol	Test Conditions		Value	Unit	
I _{GT}	V _D = 12V; R _L = 30 Ω		MAX.	50	mA
			MIN.	5	
V _{GT}			MAX.	2.0	V
dv/dt	V _D = V _{DRM} ; gate open; T _J = 100°C	400V	MIN.	650	V/μs
		600V		600	
		800V		500	
	1000V	250			
	V _D = V _{DRM} ; gate open; T _J = 125°C	400V		550	
		600V		500	
800V		475			
V _{GD}	V _D = V _{DRM} ; R _L = 3.3 kΩ; T _J = 125°C		MIN.	0.2	V
I _H	I _T = 400mA (initial)		MAX.	80	mA
t _q	(1)		MAX.	35	μs
t _{gt}	I _G = 2 × I _{GT} ; PW = 15μs; I _T = 140A		TYP.	2.5	μs

Note :

(1) I_T=2A; t_p=50μs; dv/dt=5V/μs; di/dt=30A/μs

Static Characteristics

Symbol	Test Conditions		Value	Unit		
V _{TM}	65A Device I _T = 130A; t _p = 380μs		MAX.	1.8	V	
	70A Device I _T = 140A; t _p = 380μs					
I _{DRM} / I _{RRM}	V _{DRM} / V _{RRM}	T _J = 25°C	400 – 800V	MAX.	20	μA
			1000 V		30	
		T _J = 100°C	400 – 600V		1500	
			800V		2000	
			1000V		5000	
			T _J = 125°C		400V – 600V	
		800V			5000	

Thermal Resistances

Symbol	Parameter	Value	Unit	
R _{θ(J-C)}	Junction to case (AC)	Sxx65J Sxx65K	0.86	°C/W
		Sxx70W	0.6	

Note: xx = voltage

Additional Information



Datasheet



Resources



Samples

Figure 1: Normalized DC Gate Trigger Current vs. Junction Temperature



Figure 2: Normalized DC Gate Trigger Voltage vs. Junction Temperature



Figure 3: Normalized DC Holding Current vs. Junction Temperature

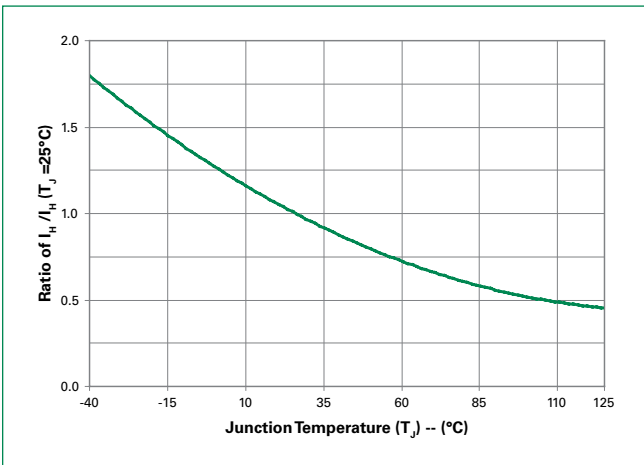

Figure 4: On-State Current vs. On-State Voltage (Typical)

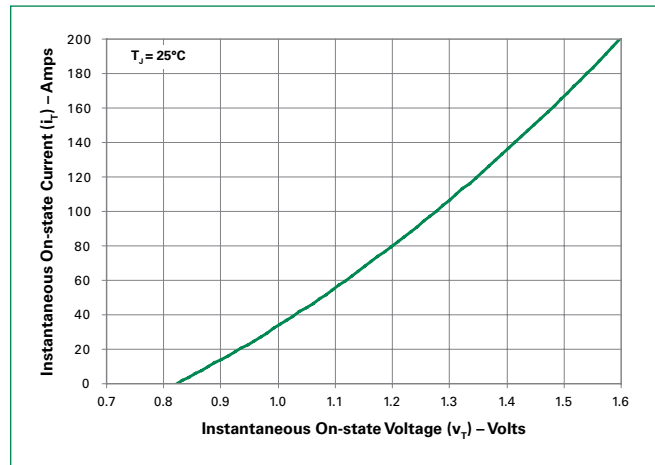

Figure 5: Power Dissipation (Typical) vs. RMS On-State Current

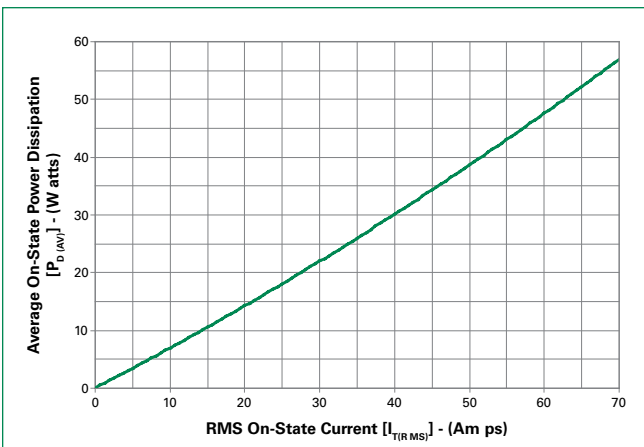
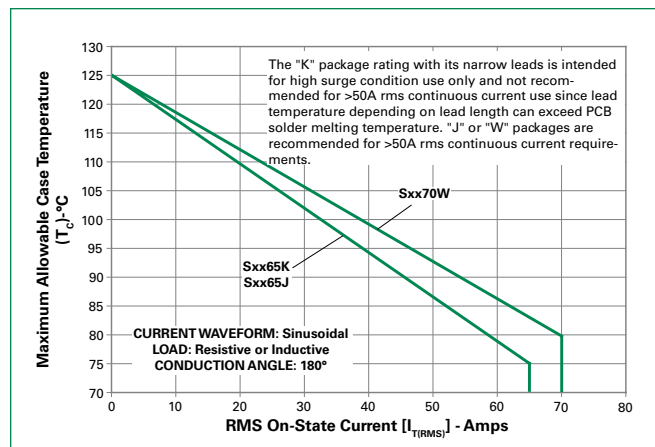

Figure 6: Maximum Allowable Case Temperature vs. RMS On-State Current



Note: xx = voltage

Figure 7: Maximum Allowable Case Temperature vs. Average On-State Current



Figure 8: Peak Capacitor Discharge Current



Figure 9: Peak Capacitor Discharge Current Derating



Figure 10: Surge Peak On-State Current vs. Number of Cycles



SUPPLY FREQUENCY: 60 Hz Sinusoidal
LOAD: Resistive
RMS On-State Current: $I_{T(RMS)}$: Maximum Rated Value at Specified Case Temperature

Notes:

1. Gate control may be lost during and immediately following surge current interval.
2. Overload may not be repeated until junction temperature has returned to steady-state rated value.

Note: xx = Voltage

Soldering Parameters

Reflow Condition		Pb – Free assembly
Pre Heat	- Temperature Min ($T_{s(min)}$)	150°C
	- Temperature Max ($T_{s(max)}$)	200°C
	- Time (min to max) (t_s)	60 – 180 secs
Average ramp up rate (Liquidus Temp) (T_L) to peak		5°C/second max
$T_{s(max)}$ to T_L - Ramp-up Rate		5°C/second max
Reflow	- Temperature (T_L) (Liquidus)	217°C
	- Temperature (t_l)	60 – 150 seconds
Peak Temperature (T_p)		260 ^{+0/-5} °C
Time within 5°C of actual peak Temperature (t_p)		20 – 40 seconds
Ramp-down Rate		5°C/second max
Time 25°C to peak Temperature (T_p)		8 minutes Max.
Do not exceed		280°C

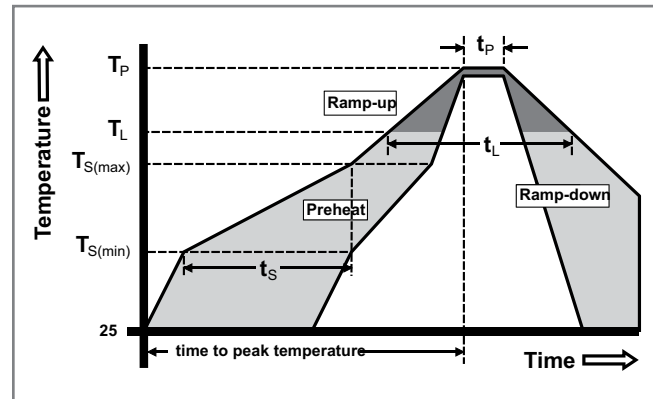

Physical Specifications

Terminal Finish	100% Matte Tin-plated
Body	UL recognized epoxy meeting flammability classification 94V-0
Lead Material	Copper Alloy

Design Considerations

Careful selection of the correct device for the application's operating parameters and environment will go a long way toward extending the operating life of the Thyristor. Good design practice should limit the maximum continuous current through the main terminals to 75% of the device rating. Other ways to ensure long life for a power discrete semiconductor are proper heat sinking and selection of voltage ratings for worst case conditions. Overheating, overvoltage (including dv/dt), and surge currents are the main killers of semiconductors. Correct mounting, soldering, and forming of the leads also help protect against component damage.

Environmental Specifications

Test	Specifications and Conditions
AC Blocking	MIL-STD-750, M-1040, Cond A Applied Peak AC voltage @ 125°C for 1008 hours
Temperature Cycling	MIL-STD-750, M-1051, 100 cycles; -40°C to +150°C; 15-min dwell-time
Temperature/Humidity	EIA / JEDEC, JESD22-A101 1008 hours; 320V - DC; 85°C; 85% rel humidity
High Temp Storage	MIL-STD-750, M-1031, 1008 hours; 150°C
Low-Temp Storage	1008 hours; -40°C
Resistance to Solder Heat	MIL-STD-750 Method 2031
Solderability	ANSI/J-STD-002, category 3, Test A
Lead Bend	MIL-STD-750, M-2036 Cond E

Dimensions – TO-218X (W Package) – Non-Isolated Mounting Tab common with Center Lead



Dimension	Inches		Millimeters	
	Min	Max	Min	Max
A	0.810	0.835	20.57	21.21
B	0.610	0.630	15.49	16.00
C	0.178	0.188	4.52	4.78
D	0.055	0.070	1.40	1.78
E	0.487	0.497	12.37	12.62
F	0.635	0.655	16.13	16.64
G	0.022	0.029	0.56	0.74
H	0.075	0.095	1.91	2.41
J	0.575	0.625	14.61	15.88
K	0.256	0.264	6.50	6.71
L	0.220	0.228	5.58	5.79
M	0.080	0.088	2.03	2.24
N	0.169	0.177	4.29	4.49
P	0.034	0.042	0.86	1.07
R	0.113	0.121	2.87	3.07
S	0.086	0.096	2.18	2.44
T	0.156	0.166	3.96	4.22
U	0.164	0.165	4.10	4.20
V	0.603	0.618	15.31	15.70
W	0.000	0.005	0.00	0.13
X	0.003	0.012	0.07	0.30
Y	0.028	0.032	0.71	0.81
Z	0.085	0.095	2.17	2.42

Dimensions – TO-218AC (K Package) – Isolated Mounting Tab

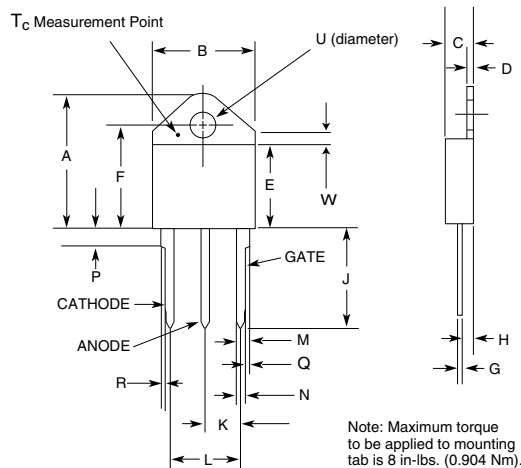

Dimension	Inches		Millimeters	
	Min	Max	Min	Max
A	0.810	0.835	20.57	21.21
B	0.610	0.630	15.49	16.00
C	0.178	0.188	4.52	4.78
D	0.055	0.070	1.40	1.78
E	0.487	0.497	12.37	12.62
F	0.635	0.655	16.13	16.64
G	0.022	0.029	0.56	0.74
H	0.075	0.095	1.91	2.41
J	0.575	0.625	14.61	15.88
K	0.211	0.219	5.36	5.56
L	0.422	0.437	10.72	11.10
M	0.058	0.068	1.47	1.73
N	0.045	0.055	1.14	1.40
P	0.095	0.115	2.41	2.92
Q	0.008	0.016	0.20	0.41
R	0.008	0.016	0.20	0.41
U	0.164	0.165	4.10	4.20
W	0.085	0.095	2.17	2.42

Dimensions – TO-218X (J Package) – Isolated Mounting Tab

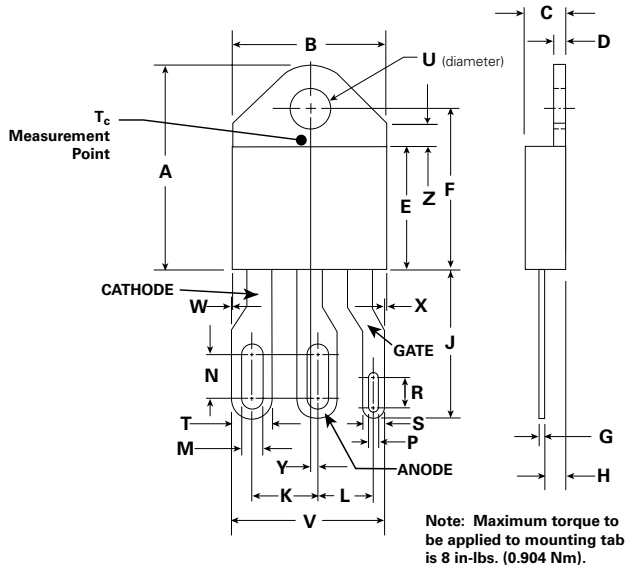

Dimension	Inches		Millimeters	
	Min	Max	Min	Max
A	0.810	0.835	20.57	21.21
B	0.610	0.630	15.49	16.00
C	0.178	0.188	4.52	4.78
D	0.055	0.070	1.40	1.78
E	0.487	0.497	12.37	12.62
F	0.635	0.655	16.13	16.64
G	0.022	0.029	0.56	0.74
H	0.075	0.095	1.91	2.41
J	0.575	0.625	14.61	15.88
K	0.256	0.264	6.50	6.71
L	0.220	0.228	5.58	5.79
M	0.080	0.088	2.03	2.24
N	0.169	0.177	4.29	4.49
P	0.034	0.042	0.86	1.07
R	0.113	0.121	2.87	3.07
S	0.086	0.096	2.18	2.44
T	0.156	0.166	3.96	4.22
U	0.164	0.165	4.10	4.20
V	0.603	0.618	15.31	15.70
W	0.000	0.005	0.00	0.13
X	0.003	0.012	0.07	0.30
Y	0.028	0.032	0.71	0.81
Z	0.085	0.095	2.17	2.42

Product Selector

Part Number	Voltage				Gate Sensitivity	Type	Package
	400V	600V	800V	1000V			
Sxx65K	X	X	X	X	50mA	Standard SCR	TO-218AC
Sxx65J	X	X	X		50mA	Standard SCR	TO-218X
Sxx70W	X	X	X		50mA	Standard SCR	TO-218X

Note: xx = Voltage

Packing Options

Part Number	Marking	Weight	Packing Mode	Base Quantity
Sxx65KTP	Sxx65K	4.40g	Tube	250 (25 per tube)
Sxx65JTP	Sxx65J	5.23g	Tube	250 (25 per tube)
Sxx70WTP	Sxx70W	5.23g	Tube	250 (25 per tube)

Note: xx = Voltage