

S8X5ECSx



Description

The S8X5ECSx offers a high static dv/dt with a low turn off (t_q) time. It is specifically designed for GFCI (Ground Fault Circuit Interrupter) and AFCI (Arc Fault Circuit Interrupter), RCD (Residual Current Device) and RCBO (Residual Current Circuit Breaker with Overload Protection) applications. All SCR junctions are glass-passivated to ensure long term reliability and parametric stability.

Main Features

Symbol	Value	Unit
I _{T(RMS)}	0.5	A
V _{DRM} /V _{RRM}	800	V
V _{DSM} (t _p = 50 μs)	1250	V
V _{RSM} (t _p = 50 μs)	900	V
I _{GT}	20 to 100	μA

Features

- Thru-hole packages
- Surge current capability < 20Amps
- Blocking voltage (V_{DRM} / V_{RRM}) capability - up to 800V
- Non-repetitive direct surge peak off-state voltage (V_{DSM}) up to 1250V
- Non-repetitive reverse surge peak off-state voltage (V_{RSM}) up to 900V
- High dv/dt noise immunity
- Improved turn-off time (t_q)
- Sensitive gate for direct microprocessor interface
- Halogen free and RoHS compliant

Schematic Symbol

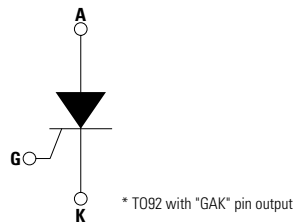

Absolute Maximum Ratings

Symbol	Parameter	Value	Unit	
I _{T(RMS)}	RMS on-state current (full sine wave)	T _C = 85°C	0.5 A	
I _{T(AV)}	Average on-state current	T _C = 85°C	0.3 A	
I _{TSM}	Non repetitive surge peak on-state current (Sine half wave, T _J initial = 25°C)	F = 50Hz	10 A	
		F = 60Hz	12 A	
I ² t	I ² t Value for fusing	t _p = 10 ms	F = 50 Hz	0.5 A ² s
di/dt	Critical rate of rise of on-state current I _G = 10mA	T _J = 125°C	80 A/μs	
I _{GM}	Peak Gate Current	t _p = 20 μs	T _J = 125°C	0.5 A
P _{G(AV)}	Average gate power dissipation	T _J = 125°C	0.2 W	
T _{stg}	Storage junction temperature range	—	-40 to 150 °C	
T _J	Operating junction temperature range	—	-40 to 125 °C	

Electrical Characteristics ($T_J = 25^\circ\text{C}$, unless otherwise specified)

Symbol	Description	Test Conditions	Limit	Value		Unit
				S8X5ECS	S8X5ECS2	
I_{GT}	DC Gate Trigger Current	$V_D = 6V$ $R_L = 100\ \Omega$	Min.	20	20	μA
			Max.	100	50	μA
V_{GT}	DC Gate Trigger Voltage	$V_D = 6V$ $R_L = 100\ \Omega$	Max.	0.8		V
V_{GRM}	Peak Reverse Gate Voltage	$I_{RG} = 10\ \mu\text{A}$	Min.	8		V
I_H	Holding Current	$R_{GK} = 1\ \text{k}\Omega$ Initial Current = 20mA	Max.	3		mA
dv/dt	Critical Rate-of-Rise of Off-State Voltage	$T_J = 125^\circ\text{C}$ $V_D = 67\%$ of V_{DRM} Exp. Waveform $R_{GK} = 1\ \text{k}\Omega$	Min.	40		V/ μs
V_{GD}	Gate Non-Trigger Voltage	$V_D = 1/2 V_{DRM}$ $R_{GK} = 1\ \text{k}\Omega$ $T_J = 125^\circ\text{C}$	Min.	0.2		V
t_q	Turn-Off Time	$I_T = 0.5\text{A}$	Max.	35		μs
t_{gt}	Turn-On Time	$I_G = 10\text{mA}$ $P_W = 15\ \mu\text{sec}$ $I_T = 1.6\text{A(pk)}$	Typ.	2.3		μs

Static Characteristics ($T_J = 25^\circ\text{C}$, unless otherwise specified)

Symbol	Description	Test Conditions	Limit	Value	Unit
V_{TM}	Peak On-State Voltage	0.5A device $I_{TM} = 4\text{A}$ $t_p = 380\ \mu\text{s}$	MAX.	1.8	V
V_{TO}	Threshold Voltage	-	MAX.	1.03	V
R_D	Dynamic Resistance	-	MAX.	106	m Ω
I_{DRM} / I_{RRM}	Off-State Current, Peak Repetitive	$T_J = 25^\circ\text{C}$	MAX.	3	μA
		$T_J = 125^\circ\text{C}$	MAX.	500	μA

Thermal Resistances

Symbol	Description	Test Conditions	Value	Unit
$R_{th(j-c)}$	Junction to case (AC)	$I_T = 0.8\text{A}_{(RMS)}$ ¹	35	$^\circ\text{C}/\text{W}$
$R_{th(j-a)}$	Junction to ambient	$I_T = 0.8\text{A}_{(RMS)}$ ¹	150	$^\circ\text{C}/\text{W}$

¹ 60Hz AC resistive load condition, 100% conduction.

Figure 1: Normalized DC Gate Trigger Current For All Quadrants vs. Junction Temperature

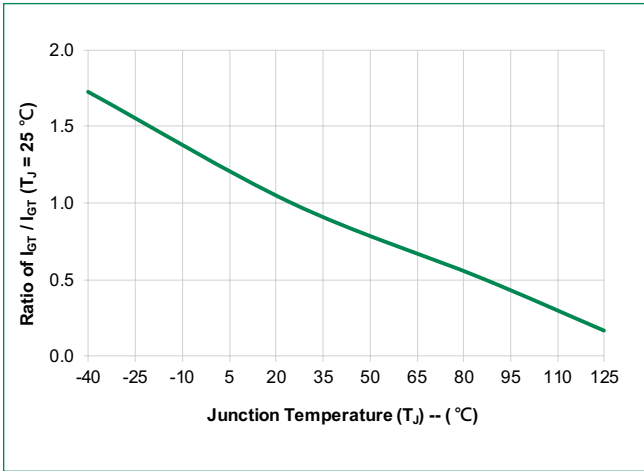

Figure 2: Normalized DC Holding Current vs. Junction Temperature

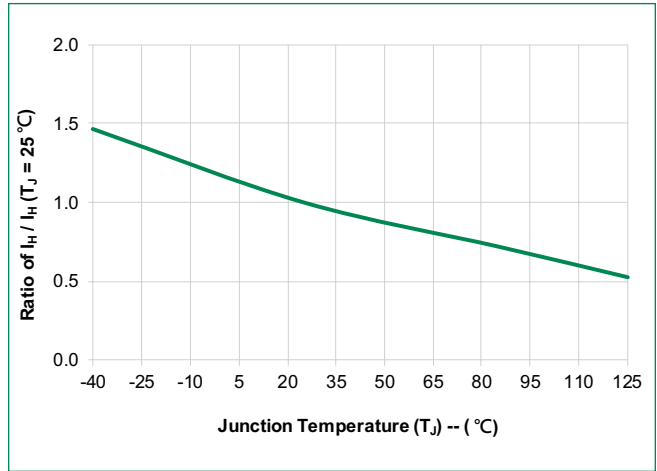

Figure 3: Normalized DC Gate Trigger Voltage vs. Junction Temperature

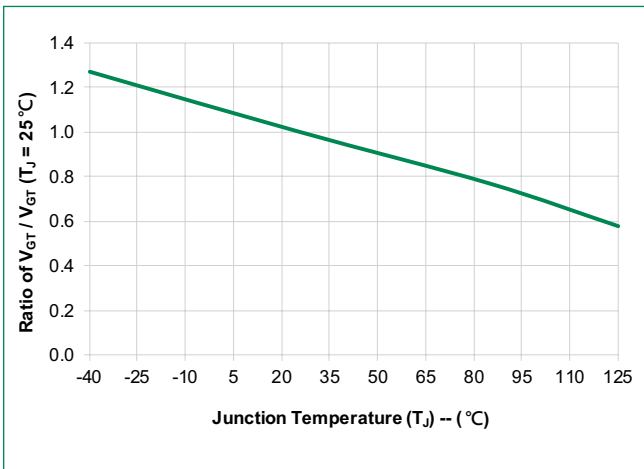

Figure 4: On-State Current vs. On-State Voltage (Typical)

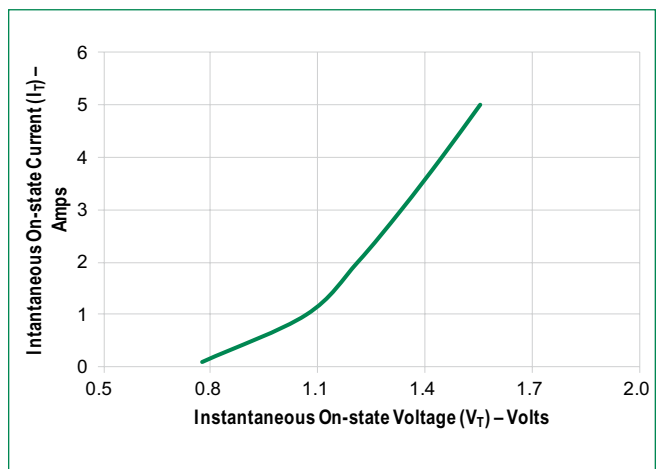

Figure 5: Power Dissipation (Typical) vs. RMS On-State Current

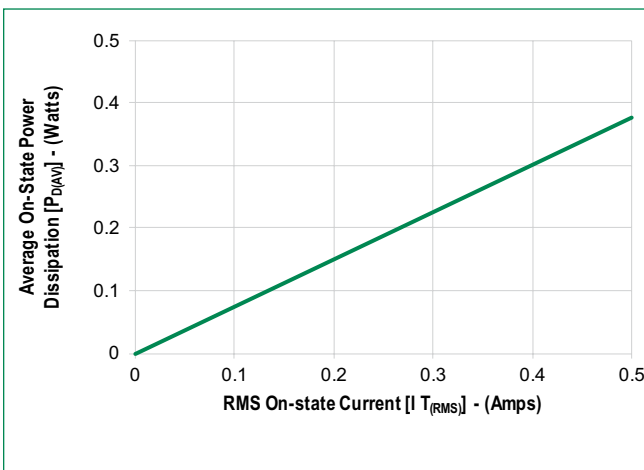

Figure 6: Maximum Allowable Case Temperature vs. On-State Current

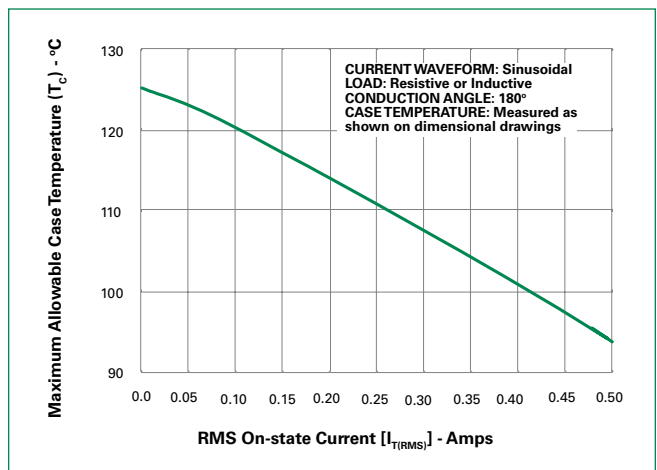
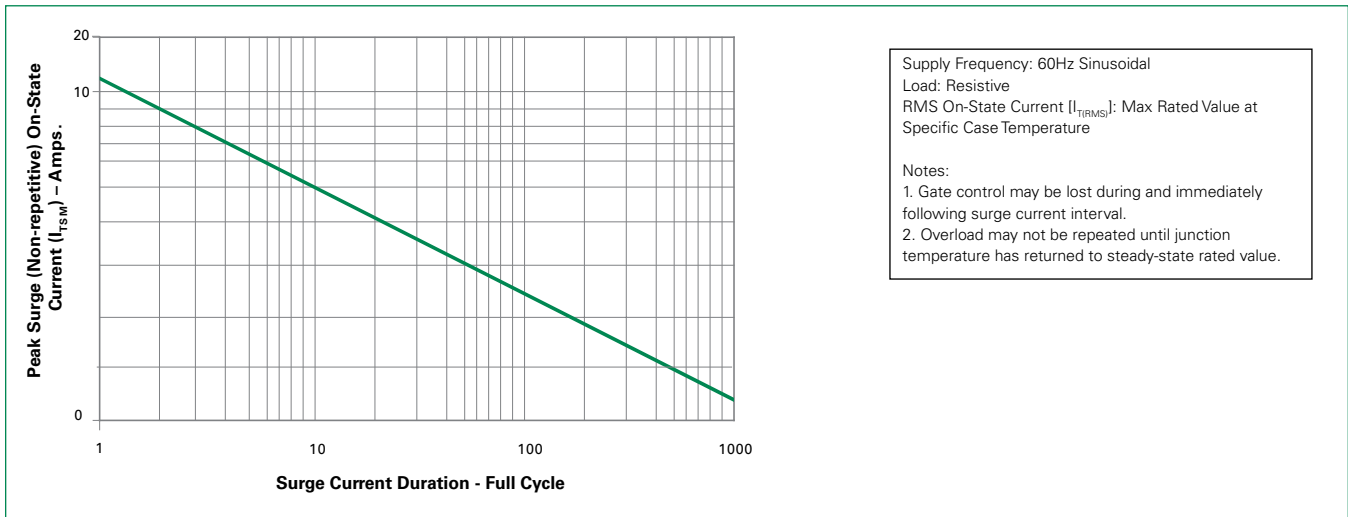
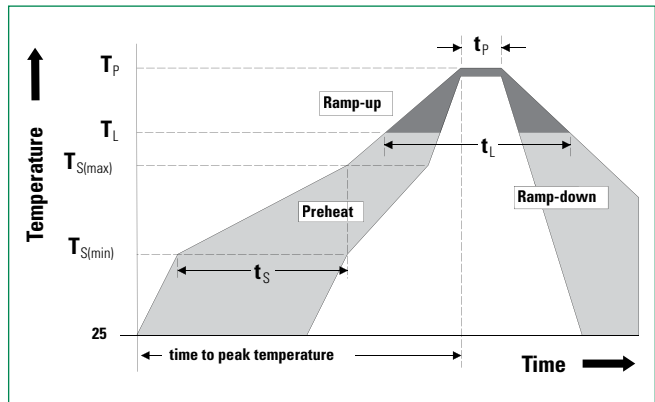

Figure 7: Surge Peak On-State Current vs. Number of Cycles



Soldering Parameters

Reflow Condition	Pb – Free assembly	
Pre Heat	- Temperature Min ($T_{s(min)}$)	150°C
	- Temperature Max ($T_{s(max)}$)	200°C
	- Time (min to max) (t_s)	60 – 180 secs
Average ramp up rate (Liquidus Temp) (T_L) to peak	5°C/second max	
$T_{S(max)}$ to T_L - Ramp-up Rate	5°C/second max	
Reflow	- Temperature (T_L) (Liquidus)	217°C
	- Time (min to max) (t_s)	60 – 150 seconds
Peak Temperature (T_p)	260 ^{+0/-5} °C	
Time within 5°C of actual peak Temperature (t_p)	20 – 40 seconds	
Ramp-down Rate	5°C/second max	
Time 25°C to peak Temperature (T_p)	8 minutes Max.	
Do not exceed	280°C	



Physical Specifications

Terminal Finish	100% Matte Tin-plated.
Body Material	UL Recognized compound meeting flammability rating V-0.
Lead Material	Copper Alloy

Design Considerations

Careful selection of the correct component for the application's operating parameters and environment will go a long way toward extending the operating life of the Thyristor. Good design practice should limit the maximum continuous current through the main terminals to 75% of the component rating. Other ways to ensure long life for a power discrete semiconductor are proper heat sinking and selection of voltage ratings for worst case conditions. Overheating, overvoltage (including dv/dt), and surge currents are the main killers of semiconductors. Correct mounting, soldering, and forming of the leads also help protect against component damage.

Reliability/Environmental Tests

Test	Specifications and Conditions
AC Blocking	MIL-STD-750, M-1040, Cond A Applied Peak AC voltage @ 125°C for 1008 hours
Temperature Cycling	MIL-STD-750, M-1051, 1000 cycles; -55°C to +150°C; 15-min dwell-time
Temperature/Humidity	EIA / JEDEC, JESD22-A101 1008 hours; 320V - DC: 85°C; 85% rel humidity
UHAST	JESD22-A118, 96 hours, 130°C, 85%RH
High Temp Storage	MIL-STD-750, M-1031, 1008 hours; 150°C
Low-Temp Storage	1008 hours; -40°C
Resistance to Solder Heat	MIL-STD-750 Method 2031
Solderability	ANSI/J-STD-002, category 3, Test A
Lead Bend	MIL-STD-750, M-2036 Cond E

Dimensions – TO-92

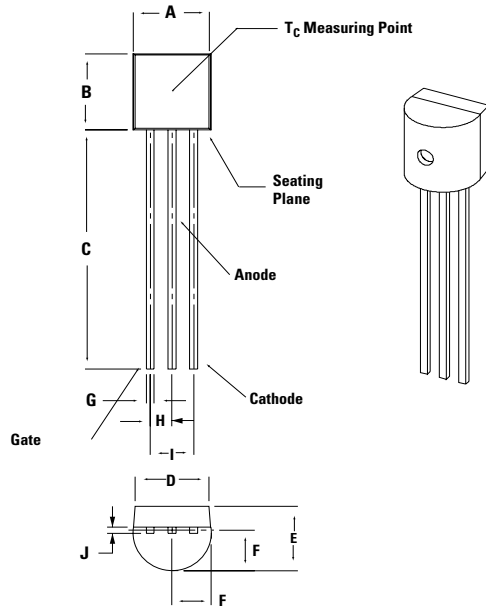

Dimension	Inches		Millimeters	
	Min	Max	Min	Max
A	0.175	0.205	4.450	5.200
B	0.170	0.210	4.320	5.330
C	0.500		12.70	
D	0.135		3.430	
E	0.125	0.165	3.180	4.190
F	0.080	0.105	2.040	2.660
G	0.016	0.021	0.407	0.533
H	0.045	0.055	1.150	1.390
I	0.095	0.105	2.420	2.660
J	0.015	0.020	0.380	0.500

Packing Option

Part Number	Marking	Weight	Packing Mode	Base Quantity
S8X5ECS	S8X5ECS	0.217G	Bulk	2500
S8X5ECSRP	S8X5ECS	0.217G	Tape & Reel	2000
S8X5ECSAP	S8X5ECS	0.217G	Ammo Pack	2000
S8X5ECS2	S8X5ECS2	0.217G	Bulk	2500
S8X5ECS2RP	S8X5ECS2	0.217G	Tape & Reel	2000
S8X5ECS2AP	S8X5ECS2	0.217G	Ammo Pack	2000