

SxX8xSx Series  
EV Series 0.8 A Sensitive SCRs



Agency Approvals and Environmental

Environmental Approvals

Product Summary

Characteristic	Value	Unit
$I_{T(RMS)}$	0.8	A
$V_{DRM} / V_{RRM}$	400, 600, or 800	V
$I_{GT}$	5 to 200	$\mu A$

Schematic Symbol

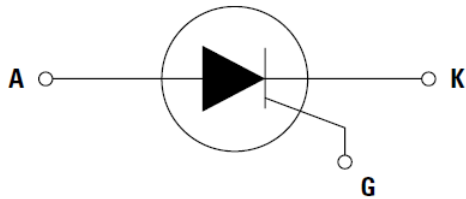

Product Description

This new component series offers high static dv/dt and low turn off time ( $t_q$ ) sensitive SCR. It is specifically designed for Ground Fault Circuit Interrupter (GFCI) and Gas Ignition applications. All SCRs junctions are glass-passivated to ensure long term reliability and parametric stability.

Features

- Surge capability > 10 A
- Blocking voltage ( $V_{DRM} / V_{RRM}$ ) capability up to 800 V
- High dv/dt noise immunity
- Improved turn-off time ( $t_q$ ) < 25  $\mu sec$
- Sensitive gate for direct microprocessor interface
- Through-hole and surface-mount packages
- RoHS compliant and Halogen-Free

Applications

The SxX8xSx EV series is specifically designed for Ground Fault Circuit Interrupter (GFCI) and gas ignition applications.

- 1. Maximum Ratings.....3
- 2. Thermal Characteristics .....3
- 3. Electrical Characteristics ( $T_J = 25\text{ }^\circ\text{C}$  unless otherwise specified) .....3
- 4. Static Characteristics ( $T_J = 25\text{ }^\circ\text{C}$  unless otherwise specified).....3
- 5. Performance Curves .....4
- 6. Soldering Parameters .....7
- 7. Physical Specifications.....7
- 8. Environmental Specifications.....7
- 9. Design Considerations.....8
- 10. Package Dimensions .....9
- 11. Part Numbering and Marking.....10
- 12. Product Selector .....11
- 13. Packing Options.....11
- 14. Packing Specifications .....11

## 1. Maximum Ratings

Symbol	Characteristic	Conditions		Value	Unit
$I_{T(RMS)}$	RMS On-state Current (Full Sine Wave)	TO-92	$T_C = 55\text{ }^\circ\text{C}$	0.8	A
		SOT-89	$T_C = 60\text{ }^\circ\text{C}$		
		SOT-223	$T_L = 60\text{ }^\circ\text{C}$		
$I_{T(AV)}$	Average On-state Current	TO-92	$T_C = 55\text{ }^\circ\text{C}$	0.51	A
		SOT-89	$T_C = 60\text{ }^\circ\text{C}$		
		SOT-223	$T_L = 60\text{ }^\circ\text{C}$		
$I_{TSM}$	Non-repetitive Surge Peak On-state Current (Single Cycle, $T_{J,Initial} = 25\text{ }^\circ\text{C}$ )	TO-92	$f = 50\text{ Hz}$	8	A
		SOT-89	$f = 60\text{ Hz}$	10	
		SOT-223			
$I^2t$	$I^2t$ Value for Fusing	$t_p = 10\text{ ms}$	$f = 50\text{ Hz}$	0.32	$\text{A}^2\text{s}$
		$t_p = 8.3\text{ ms}$	$f = 60\text{ Hz}$	0.41	
$di/dt$	Critical Rate of Rise of On-state Current $I_G = 10\text{ mA}$	TO-92 SOT-89 SOT-223	$T_J = 125\text{ }^\circ\text{C}$	50	$\text{A}/\mu\text{s}$
$I_{GM}$	Peak Gate Current	$t_p = 10\text{ }\mu\text{s}$	$T_J = 125\text{ }^\circ\text{C}$	1.0	A
$P_{G(AV)}$	Average Gate Power Dissipation	-	$T_J = 125\text{ }^\circ\text{C}$	0.1	W
$T_{STG}$	Storage Junction Temperature Range	-	-	-40 to 150	$^\circ\text{C}$
$T_J$	Operating Junction Temperature Range	-	-	-40 to 125	$^\circ\text{C}$

## 2. Thermal Characteristics

Symbol	Characteristic	Conditions	Value	Unit	
$R_{th(JC)}$	Thermal Resistance, junction-to-case (AC)	$I_T = 0.8\text{ A}_{(RMS)}^1$	TO-92	75	$^\circ\text{C}/\text{W}$
			SOT-223	30	
			SOT-89	50	
$R_{th(JA)}$	Thermal Resistance, junction-to-ambient	$I_T = 0.8\text{ A}_{(RMS)}^1$	TO-92	150	$^\circ\text{C}/\text{W}$
			SOT-223	60	
			SOT-89	90	

Note 1: 60 Hz AC resistive load condition, 100% conduction

## 3. Electrical Characteristics ( $T_J = 25\text{ }^\circ\text{C}$ unless otherwise specified)

Symbol	Description	Conditions	SxX8yS1			SxX8yS2			SxX8yS			Unit
			Min	Typ	Max	Min	Typ	Max	Min	Typ	Max	
$I_{GT}$	DC Gate Trigger Current	$V_D = 6\text{ V}, R_L = 100\text{ }\Omega$	0.5	-	5	1	-	50	15	-	200	$\mu\text{A}$
$V_{GT}$	DC Gate Trigger Voltage	$V_D = 6\text{ V}, R_L = 100\text{ }\Omega$	-	-	0.8	-	-	0.8	-	-	0.8	V
$V_{GRM}$	Peak Reverse Gate Voltage	$I_{RG} = 10\text{ }\mu\text{A}$	5	-	-	5	-	-	5	-	-	V
$I_H$	Holding Current	$R_{GK} = 1\text{ k}\Omega$ , Initial current = 20 A	-	-	5	-	-	5	-	-	5	mA
$(dv/dt)_s$	Critical Rate-of-rise of Off-stage Voltage	$T_J = 125\text{ }^\circ\text{C}, V_D = V_{DRM}/V_{RRM}$ , $R_{GK} = 1\text{ k}\Omega$ , Exponential waveform	75	-	-	75	-	-	75	-	-	$\text{V}/\mu\text{s}$
$t_q$	Turn-off Time	$T_J = 25\text{ }^\circ\text{C} @ 600\text{ V}, R_{GK} = 1\text{ k}\Omega$	-	-	30	-	-	25	-	-	25	$\mu\text{s}$
$t_{gt}$	Turn-on Time	$I_G = 10\text{ mA}, P_W = 15\text{ }\mu\text{s}, I_T = 1.6\text{ A}_{PK}$	-	2	-	-	2	-	-	2	-	$\mu\text{s}$
$V_{GD}$	Gate Non-trigger Voltage	$V_D = V_{DRM}, R_{GK} = 1\text{ k}\Omega, T_J = 125\text{ }^\circ\text{C}$	0.2	-	-	0.2	-	-	0.2	-	-	V

Note: x = voltage /100, y = package

## 4. Static Characteristics ( $T_J = 25\text{ }^\circ\text{C}$ unless otherwise specified)

Symbol	Description	Conditions	Value		Unit
			Min	Max	
$V_{TM}$	Peak On-state Voltage	$I_{TM} = 1.6\text{ A}_{PK}$	-	1.70	V
$I_{DRM}$	Off-state Current, Peak Repetitive	$T_J = 25\text{ }^\circ\text{C} @ V_D = V_{DRM}, R_{GK} = 1\text{ k}\Omega$	-	3	$\mu\text{A}$
		$T_J = 125\text{ }^\circ\text{C} @ V_D = V_{DRM}, R_{GK} = 1\text{ k}\Omega$	-	500	

### 5. Performance Curves

Figure 1. Normalized DC Gate Trigger Current for All Quadrants vs. Junction Temperature

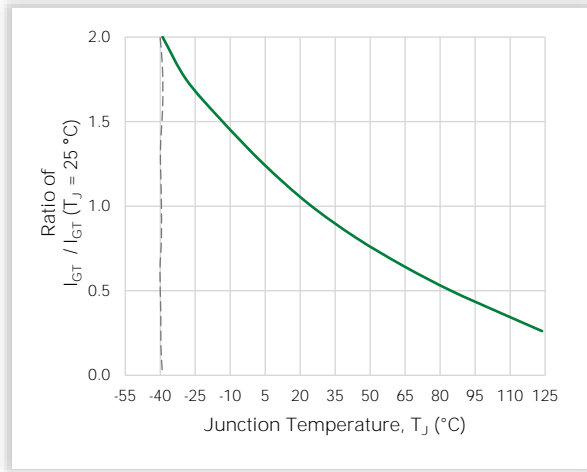

Figure 2. Normalized DC Holding Current vs. Junction Temperature

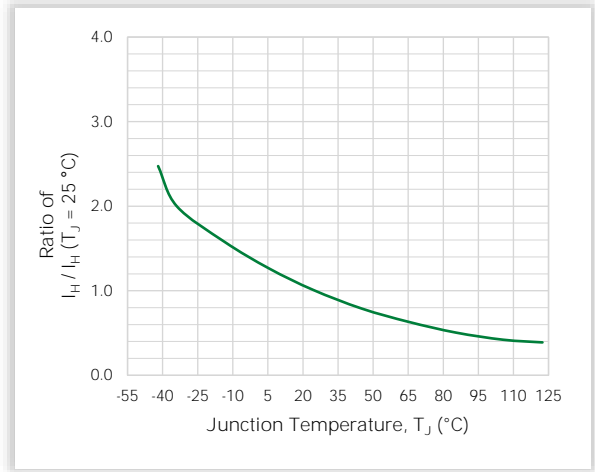

Figure 3. Normalized DC Gate Trigger Voltage vs. Junction Temperature

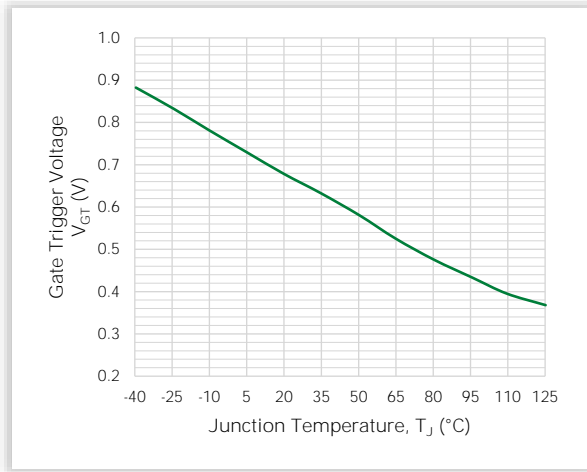

Figure 4. Typical On-state Current vs. On-state Voltage

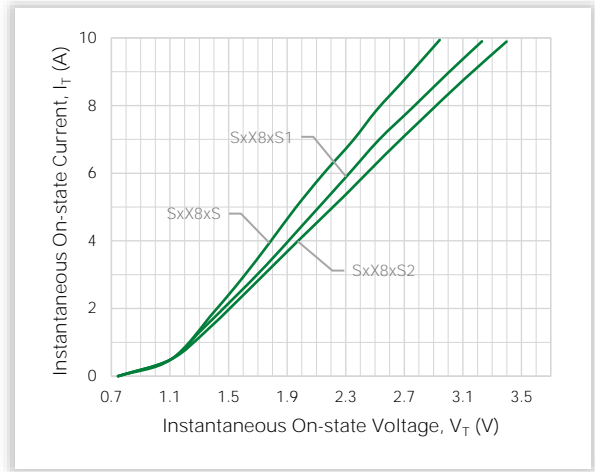

Figure 5. Typical Power Dissipation vs. RMS On-state Current

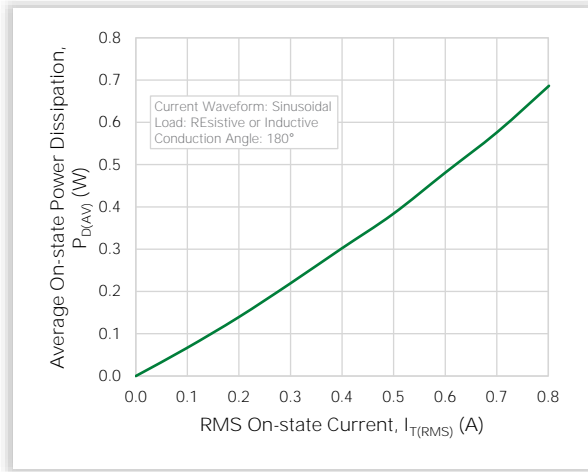

Figure 6. Maximum Allowable Case Temperature vs. On-state Current

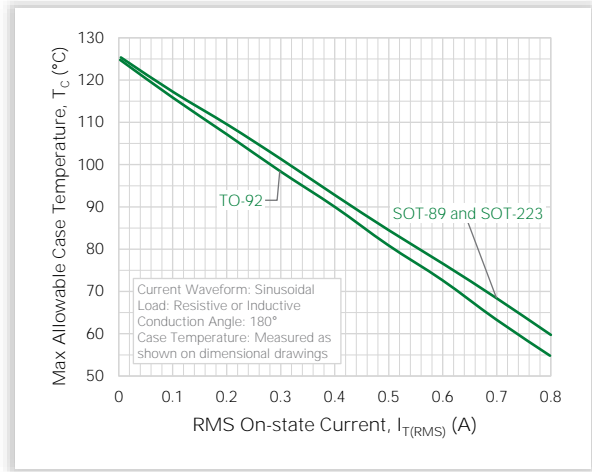

Figure 7. Typical DC Gate Trigger Current with R<sub>GK</sub> vs. Junction Temperature for S6X8xS

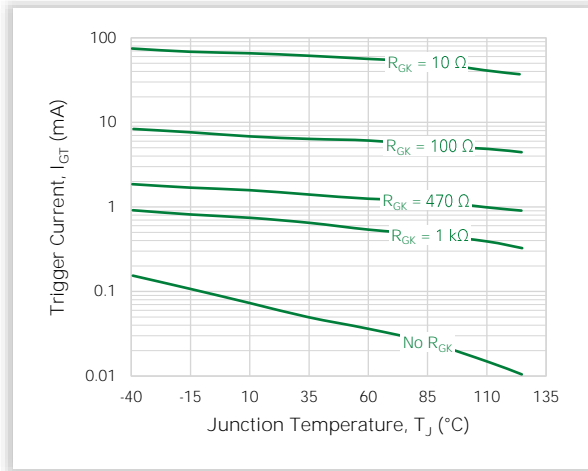

Figure 8. Typical DC Gate Trigger Current with R<sub>GK</sub> vs. Junction Temperature for S8X8xS

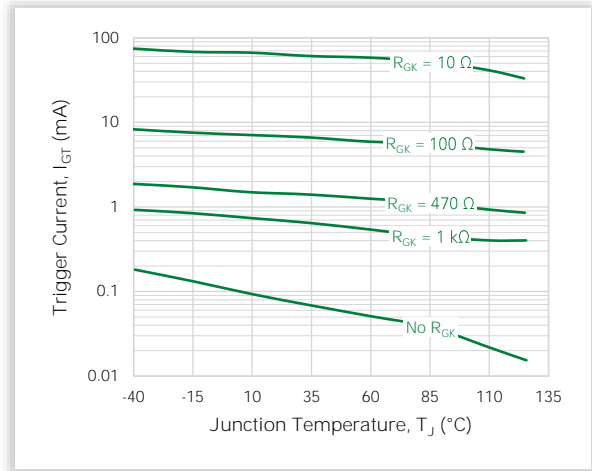

Figure 9. Typical DC Holding Current with R<sub>GK</sub> vs. Junction Temperature for S6X8xS

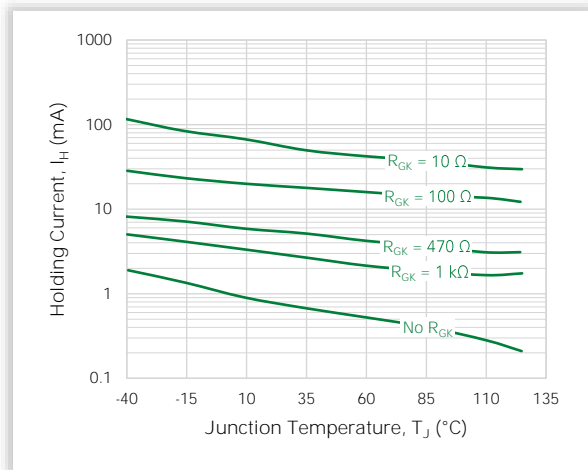

Figure 10. Typical DC Holding Current with R<sub>GK</sub> vs. Junction Temperature for S8X8xS

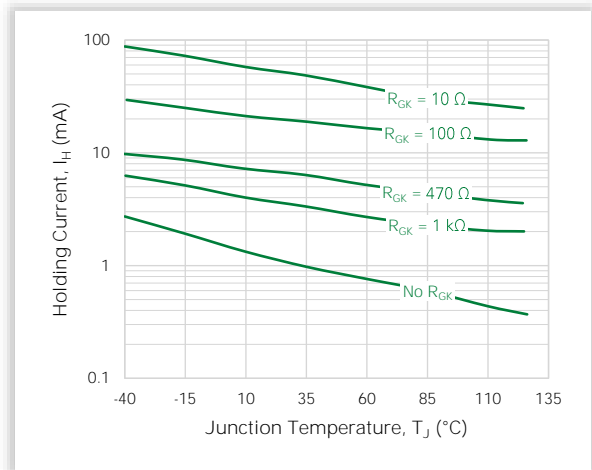

Figure 11. Typical DC Static dv/dt with R<sub>GK</sub> vs. Junction Temperature for S6X8xS

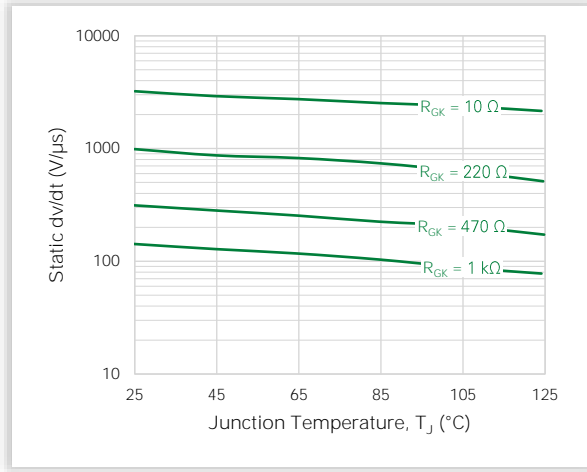

Figure 12. Typical DC Static dv/dt with R<sub>GK</sub> vs. Junction Temperature for S8X8xS

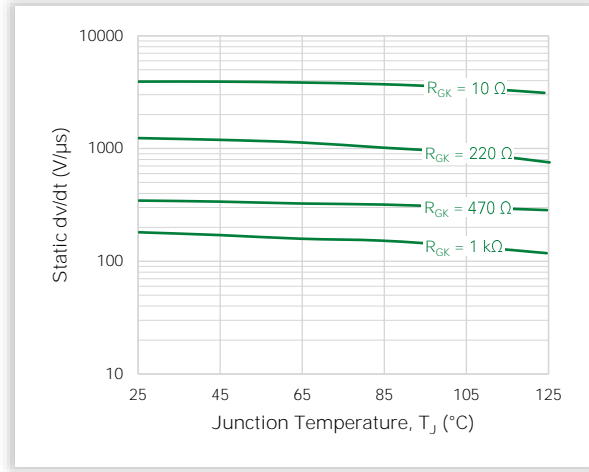

Figure 13. Typical DC Turn-off Time with R<sub>GK</sub> vs. Junction Temperature for S6X8xS

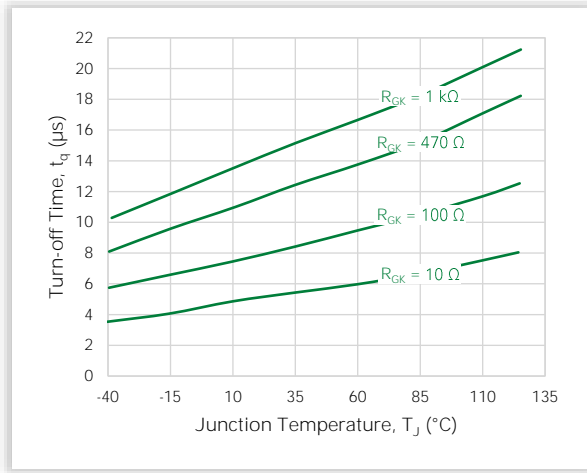

Figure 14. Typical DC Turn-off Time with R<sub>GK</sub> vs. Junction Temperature for S8X8xS

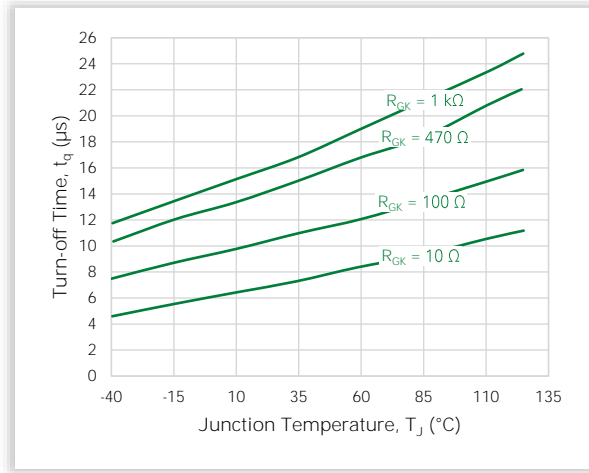
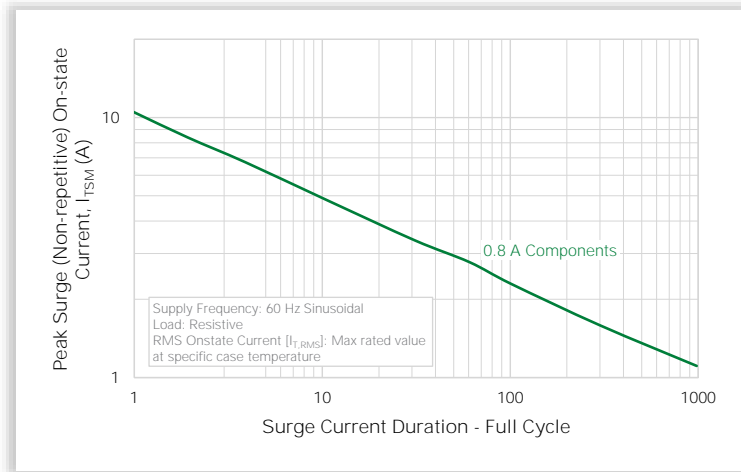

Figure 15. Surge Peak On-state Current vs. Number of Cycles



Notes

1. Gate control may be lost during and immediately following surge current interval.
2. Overload may not be repeated until junction temperature has returned to steady-state rated value.

Figure 16. Peak Repetitive Sinusoidal Pulse Current

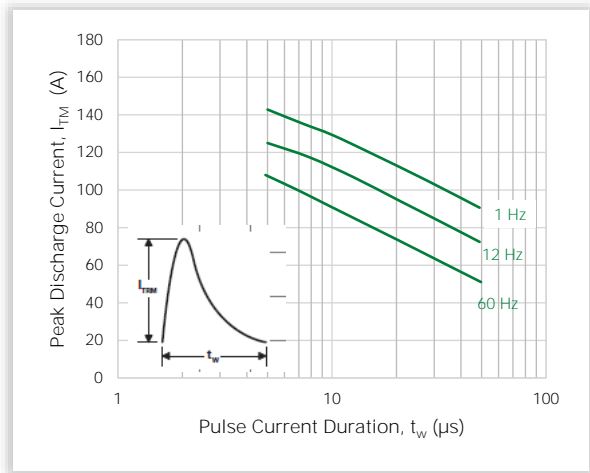

### 6. Soldering Parameters

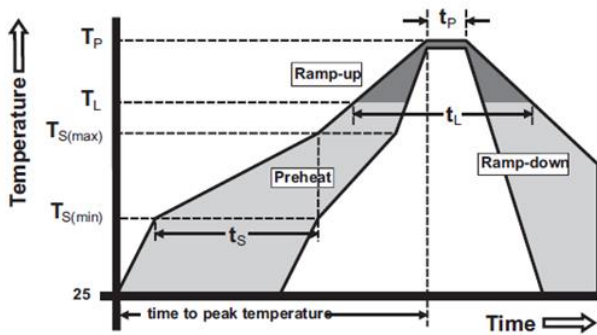

Parameter	Value	
Reflow Condition	Pb-free Assembly	
Pre-Heat	Temperature Min, $T_{S(Min)}$	150 °C
	Temperature Max, $T_{S(Max)}$	200 °C
	Time (Min to Max), $t_s$	60 to 180 s
Average Ramp-up Rate Liquidus Temp., $T_L$ to peak		5 °C/s (Max)
$T_{S(Max)}$ to $T_L$ Ramp-up Rate		5 °C/s (Max)
Reflow	Temperature, $T_L$ Liquidus	217 °C
	Time, $t_s$	60 to 150 s
Peak Temperature, $T_P$		260 °C ( $\pm 5$ °C)
Time within 5 °C of Actual Peak Temperature, $t_P$		20 to 40 s
Ramp-down Rate		5 °C/s (Max)
Time 25 °C to Peak Temperature, $T_P$		8 minutes (Max)
Do Not Exceed		280 °C

### 7. Physical Specifications

Device Feature	Detail
Terminal Finish	100% Matte Tin-plated
Body Material	UL Recognized Compound meeting Flammability Rating V-0
Lead Material	Copper Alloy

### 8. Environmental Specifications

Test	Specifications and Conditions
AC Blocking	MIL-STD-750, M-1040, Cond A Applied Peak AC voltage @ 110°C for 1008 hours
Temperature Cycling	MIL-STD-750, M-1051, 100 cycles: -40°C to +150°C; 15 min dwell time
Temperature/Humidity	EIA / JEDEC, JESD22-A101 1008 hours; 320V - DC; 85°C; 85% relative humidity
High-temp Storage	MIL-STD-750, M-1031, 1008 hours, 150°C
Low-temp Storage	1008 hours, -40°C
Resistance to Solder Heat	MIL-STD-750 Method 2031
Solderability	ANSI/J-STD-002, category 3, Test A
Lead Bend	MIL-STD-750, M-2036 Cond E

## 9. Design Considerations

Careful selection of the correct component for the application's operating parameters and environment will go a long way toward extending the operating life of the Thyristor. Good design practice should limit the maximum continuous current through the main terminals to 75% of the component rating. Other ways to ensure long life for a power discrete semiconductor are proper heat sinking and selection of voltage ratings for worst case conditions. Overheating, overvoltage (including  $dv/dt$ ), and surge currents are the main killers of semiconductors. Correct mounting, soldering, and forming of the leads also help protect against component damage.



### 10. Package Dimensions

#### TO-92

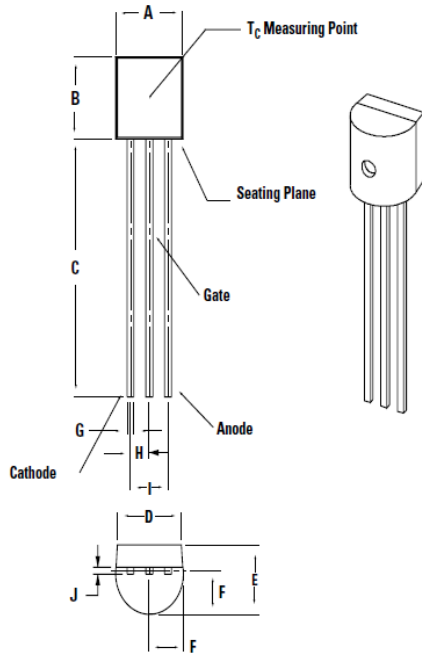

Dimension	Millimeters		Inches	
	Min	Max	Min	Max
A	4.450	5.200	0.175	0.205
B	4.320	5.330	0.170	0.210
C	12.700	-	0.500	-
D	3.430	-	0.135	-
E	3.180	4.190	0.125	0.165
F	2.040	2.660	0.080	0.105
G	0.407	0.533	0.016	0.021
H	1.150	1.390	0.045	0.055
I	2.420	2.660	0.095	0.105
J	0.380	0.500	0.015	0.020

#### SOT-223

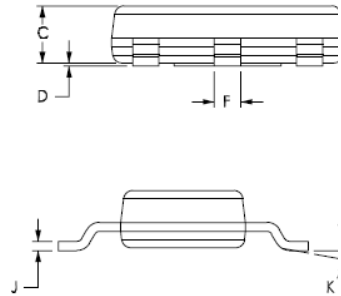
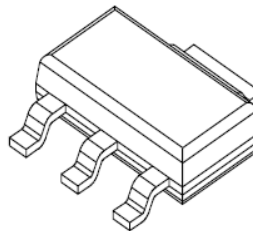
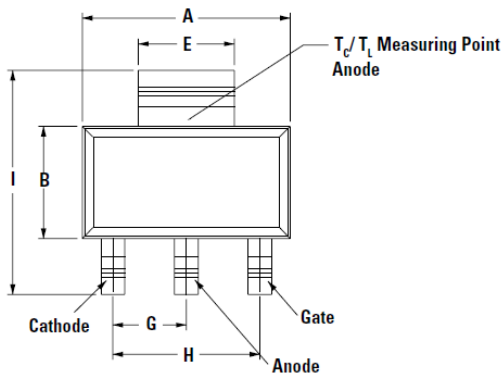

#### Pad Layout for SOT-223

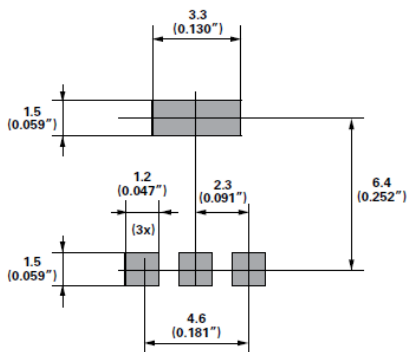

\*Dimensions in millimeters (inches)

Dimension	Millimeters			Inches		
	Min	Typ	Max	Min	Typ	Max
A	6.30	6.50	6.70	0.248	0.256	0.264
B	3.30	3.50	3.70	0.130	0.138	0.146
C	-	-	1.80	-	-	0.071
D	0.02	-	0.10	0.001	-	0.004
E	2.90	3.00	3.15	0.114	0.118	0.124
F	0.60	0.70	0.85	0.024	0.027	0.034
G	-	2.30	-	-	0.090	-
H	-	4.60	-	-	0.181	-
I	6.70	7.00	7.30	0.264	0.276	0.287
J	0.24	0.26	0.35	0.009	0.010	0.014
K	10° MAX					

SOT-89

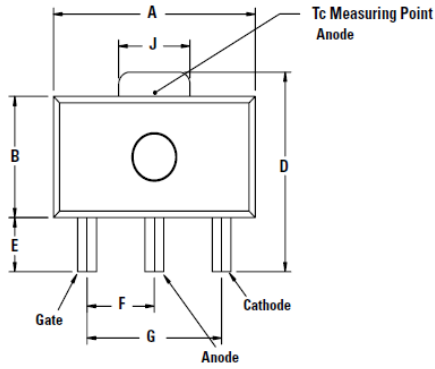

Pad Layout for SOT-89

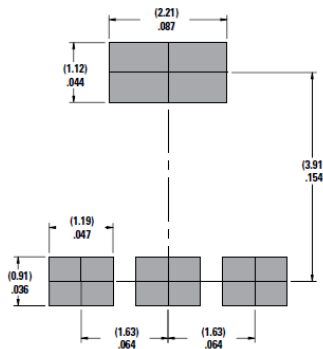

\* Dimensions in millimeters (inches)

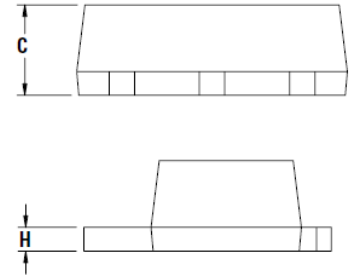
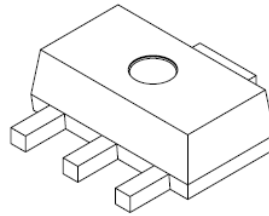

Dimension	Millimeters			Inches		
	Min	Typ	Max	Min	Typ	Max
A	4.40	-	4.60	0.173	-	0.181
B	2.29	-	2.60	0.090	-	0.102
C	1.40	-	1.60	0.055	-	0.063
D	3.94	-	4.25	0.155	-	0.167
E	0.81	-	1.20	0.032	-	0.047
F	-	1.50	-	-	0.059	-
G	-	3	-	-	0.118	-
H	0.35	-	0.44	0.014	-	0.017
I	0.36	-	0.48	0.014	-	0.019
J	-	1.65	-	-	0.065	-

11. Part Numbering and Marking

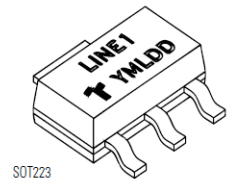
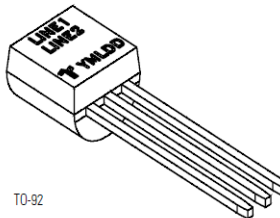
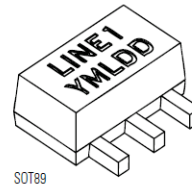
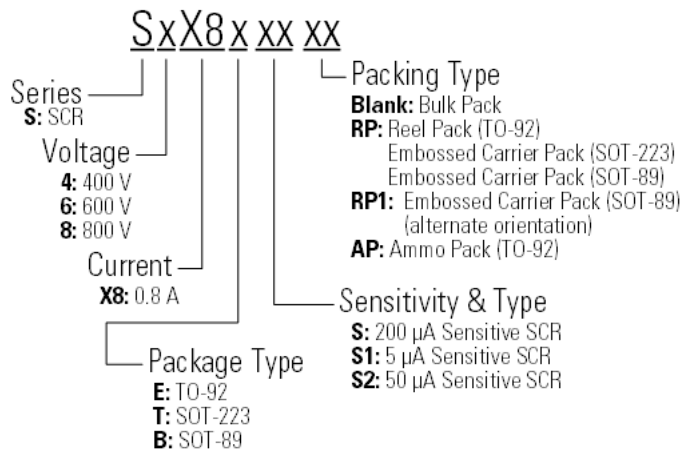

Line 1 = Littelfuse Part Number  
Line 2 = continuation... Littelfuse Part Number  
Y = Last Digit of Calendar Year  
M = Letter Month Code (A-L for Jan-Dec)  
L = Location Code  
DD = Calendar Date

### 12. Product Selector

Part Number	Voltage			Gate Sensitivity	Package
	400 V	600 V	800 V		
SxX8BS	X	X	-	200 $\mu$ A	SOT-89
SxX8ES	X	X	X	200 $\mu$ A	TO-92
SxX8TS	X	X	X	200 $\mu$ A	SOT-223
SxX8BS1	X	X	-	5 $\mu$ A	SOT-89
SxX8ES1	X	X	X	5 $\mu$ A	TO-92
SxX8TS1	X	X	X	5 $\mu$ A	SOT-223
SxX8BS2	X	X	-	50 $\mu$ A	SOT-89
SxX8ES2	X	X	X	50 $\mu$ A	TO-92
SxX8TS2	X	X	X	50 $\mu$ A	SOT-223

### 13. Packing Options

Part Number	Marking	Weight	Packing Mode	Base Quantity
SxX8ESy	SxX8ESy	0.217 g	Bulk	2500
SxX8ESyAP	SxX8ESy	0.217 g	Ammo Pack	2000
SxX8ESyRP	SxX8ESy	0.217 g	Tape & Reel	2000
SxX8TSyRP	SxX8TSy	0.120 g	Tape & Reel	1000
SxX8BSyRP	xX8y	0.053 g	Tape & Reel	1000
SxX8BSyRP1	xX8y	0.053 g	Tape & Reel	1000

Note: x = voltage/100, y = gate sensitivity

### 14. Packing Specifications

#### TO-92 (3-lead) Reel Pack (RP) Radial Leaded Specifications

Meets all EIA-468-C Standards

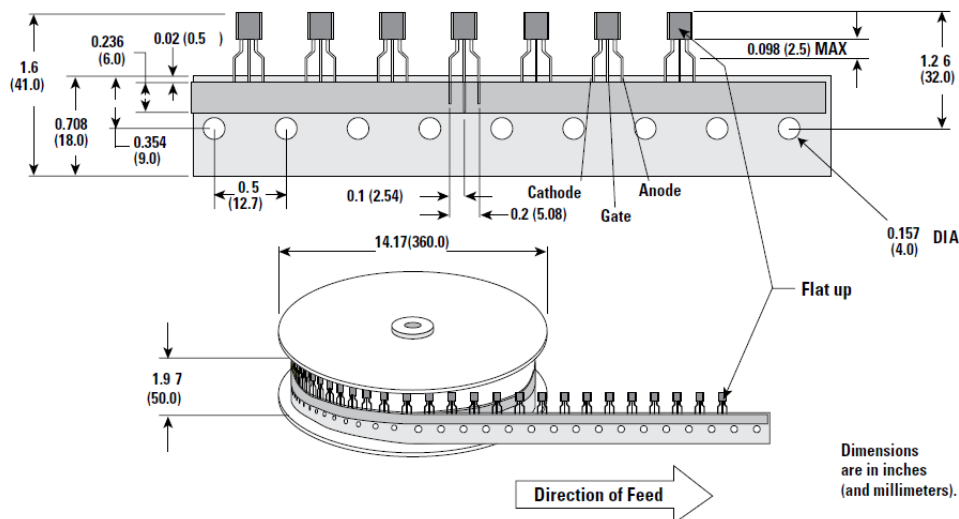

TO-92 (3-lead) Ammo Pack (AP) Radial Leaded Specifications

Meets all EIA-468-C Standards

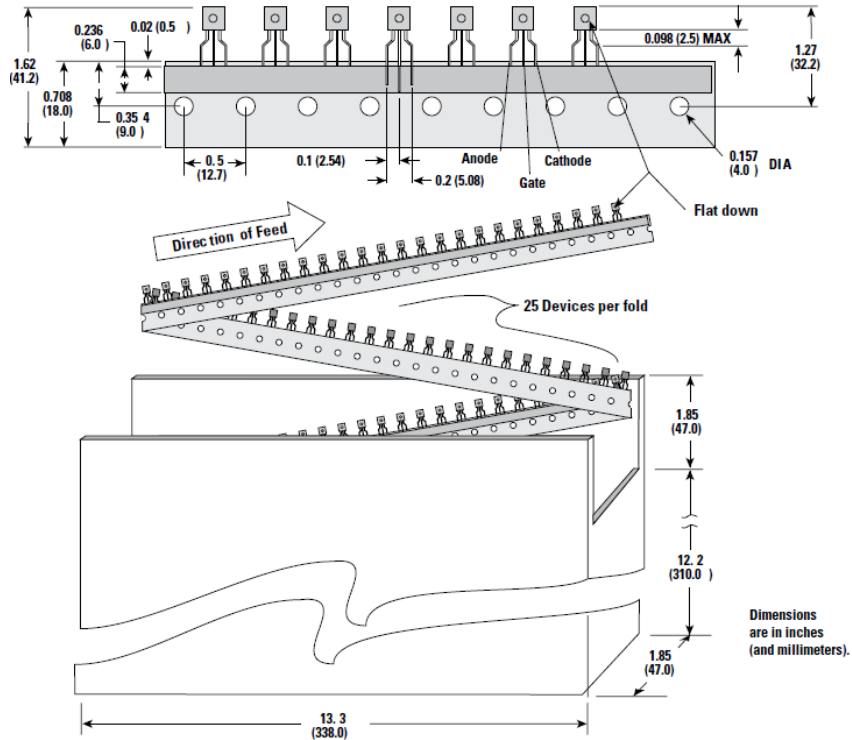

SOT-89 Reel Pack (RP) Specifications

