

SA1E Miniature Photoelectric Switches



Key features:

- Seven sensing methods: through-beam, polarized retroreflective, small beam reflective, diffuse, background suppression, convergent, and transparent.
- 2m cable type and M8 connector.
- NPN output, PNP output, light ON, dark ON can be selected.
- Coaxial polarized retro-reflective type (SA1E-X) available for sensing transparent objects.
- Background suppression (SA1E-B) type detects objects only, ignoring the background.
- Red LED available for easy alignment in long distance applications (SA1E-T, -P, -N, and -B)
- Convergent reflective type (SA1E-G) is ideal for detecting objects at a short distance with a background.
- Also available without sensitivity adjustment (SA1E-T, -P)
- Air blower mounting block for installing an air blower to clean the lens surface. Ideal to maintain a clean lens surface and sensor performance.
- UL Listed and CE marked
- IP67

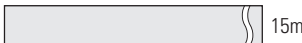
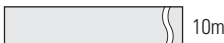

Part Numbers

Photoelectric Switches

Sensing Method		Sensing Range	Connection	Cable Length	Operation Mode	Part No.	
						NPN Output	PNP Output
Through-beam	Infrared LED w/Sensitivity Adjustment	 10m	Cable	2m	Light ON	SA1E-TN1-2M	SA1E-TP1-2M
					Dark ON	SA1E-TN2-2M	SA1E-TP2-2M
			Connector	-	Light ON	SA1E-TN1C	SA1E-TP1C
					Dark ON	SA1E-TN2C	SA1E-TP2C
	Infrared LED w/o Sensitivity Adjustment	 15m	Cable	2m	Light ON	SA1E-TN1-NA-2M	SA1E-TP1-NA-2M
					Dark ON	SA1E-TN2-NA-2M	SA1E-TP2-NA-2M
			Connector	-	Light ON	SA1E-TN1C-NA	SA1E-TP1C-NA
					Dark ON	SA1E-TN2C-NA	SA1E-TP2C-NA
	Red LED w/Sensitivity Adjustment	 10m	Cable	2m	Light ON	SA1E-TAN1-2M	SA1E-TAP1-2M
					Dark ON	SA1E-TAN2-2M	SA1E-TAP2-2M
			Connector	-	Light ON	SA1E-TAN1C	SA1E-TAP1C
					Dark ON	SA1E-TAN2C	SA1E-TAP2C
Class 1 Laser w/Sensitivity Adjustment	 30m	Cable	2m	Light ON/ Dark ON	SA1E-LTN3-2M	SA1E-LTP3-2M	
		Connector	-	Light ON/ Dark ON	SA1E-LTN3C	SA1E-LTP3C	

OI Touchscreens

PLCs

Automation Software

Power Supplies

Sensors

Communication

Barriers

Photoelectric Switches

Sensing Method		Sensing Range	Connection	Cable Length	Operation Mode	Part No.		
						NPN Output	PNP Output	
Polarized Retroreflective	Red LED	<p>(Note) Note: Maintain at least the distance shown in the () between the SA1E photoelectric switch and reflector. Reflectors are not supplied and must be ordered separately. See the characteristics on page 219.</p>	Cable	2m	Light ON	SA1E-PN1-2M	SA1E-PP1-2M	
					Dark ON	SA1E-PN2-2M	SA1E-PP2-2M	
			Connector	-	Light ON	SA1E-PN1C	SA1E-PP1C	
					Dark ON	SA1E-PN2C	SA1E-PP2C	
	w/Sensitivity Adjustment		Cable	2m	Light ON	SA1E-PN1-NA-2M	SA1E-PP1-NA-2M	
					Dark ON	SA1E-PN2-NA-2M	SA1E-PP2-NA-2M	
			Connector	-	Light ON	SA1E-PN1C-NA	SA1E-PP1C-NA	
					Dark ON	SA1E-PN2C-NA	SA1E-PP2C-NA	
Class 1 Laser	w/Sensitivity Adjustment		Cable	2m	Light ON/ Dark ON	SA1E-LPN3-2M	SA1E-LPP3-2M	
			Connector	-	Light ON/ Dark ON	SA1E-LPN3C	SA1E-LPP3C	
Diffuse-reflective	Infrared LED		Cable	2m	Light ON	SA1E-DN1-2M	SA1E-DP1-2M	
					Dark ON	SA1E-DN2-2M	SA1E-DP2-2M	
	w/Sensitivity Adjustment		-	Light ON	SA1E-DN1C	SA1E-DP1C		
				Dark ON	SA1E-DN2C	SA1E-DP2C		
Small-beam Reflective	Red LED		Cable	2m	Light ON	SA1E-NN1-2M	SA1E-NP1-2M	
					Dark ON	SA1E-NN2-2M	SA1E-NP2-2M	
	w/Sensitivity Adjustment		-	Light ON	SA1E-NN1C	SA1E-NP1C		
				Dark ON	SA1E-NN2C	SA1E-NP2C		
Background Suppression	Red LED		Cable	2m	Light ON	SA1E-BN1-2M	SA1E-BP1-2M	
					Dark ON	SA1E-BN2-2M	SA1E-BP2-2M	
			w/Sensing Range Adjustment	-	Light ON	SA1E-BN1C	SA1E-BP1C	
	Dark ON	SA1E-BN2C			SA1E-BP2C			
	Class 1 Laser	w/Sensitivity Adjustment		Cable	2m	Light ON/ Dark ON	SA1E-LBN3-2M	SA1E-LBP3-2M
						Connector	-	Light ON/ Dark ON

OT Touchscreens

PLCs

Automation Software

Power Supplies

Sensors

Communication

Barriers

Photoelectric Switches

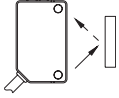
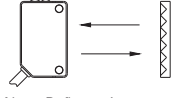
Sensing Method		Sensing Range	Connection	Cable Length	Operation Mode	Part No.	
						NPN Output	PNP Output
Convergent Reflective	Infrared LED w/Sensitivity Adjustment	 5 to 35 mm	Cable	2m	Light ON	SA1E-GN1-2M	SA1E-GP1-2M
					Dark ON	SA1E-GN2-2M	SA1E-GP2-2M
			Connector	-	Light ON	SA1E-GN1C	SA1E-GP1C
					Dark ON	SA1E-GN2C	SA1E-GP2C
Coaxial Polarized Retro-reflective	Red LED w/Sensitivity Adjustment	 Note: Reflector is not supplied and must be ordered separately. See characteristics diagrams on page 219. 2.0m (when using IAC-R9) 1.0m [100 mm] (when using IAC-R10) 1.0m [100 mm] (when using IAC-R11)	Cable	2m	Light ON	SA1E-XN1-2M	SA1E-XP1-2M
					Dark ON	SA1E-XN2-2M	SA1E-XP2-2M
			Connector	-	Light ON	SA1E-XN1C	SA1E-XP1C
					Dark ON	SA1E-XN2C	SA1E-XP2C

For more information, visit www.IDEC.com/sensors

Specifications

Sensing Method	Through-beam	Polarized Retroreflective	Diffuse-reflective	Small-beam Reflective	Background Suppression (BGS)	Convergent Reflective	Transparent	
Part No.	SA1E-□T	SA1E-□P	SA1E-D	SA1E-N	SA1E-□B	SA1E-G	SA1E-X	
Power Voltage	12 to 24V DC (Operating range: 10 to 30V DC) Equipped with reverse-polarity protection							
Current Draw	Projector: 15 mA Receiver: 20 mA Laser Receiver: 30 mA	30 mA with laser: 35 mA					20 mA maximum	
Sensing Range	With sensitivity adjustment: 10m Laser models: 30m	With sensitivity adjustment: 2.5m (IAC-R5/R8) 1.5m (IAC-R6) 1.3m (IAC-RS2) 1.0m (IAC-RS1) 0.8m (IAC-R7□) ¹ Laser models 0.3-10m	700 mm (using 200 × 200 mm white mat paper)	50 to 150 mm (using 100 × 100 mm white mat paper)	20 mm to preset (using 200 × 200 mm white mat paper) with laser: 20 - 300mm	5 to 35 mm (using 100 × 100 mm white mat paper)	2m (when using IAC-R9)	
	Without sensitivity adjustment: 15m	Without sensitivity adjustment: 3.0m (IAC-R5/R8) 2.0m (IAC-R6) 1.4m (IAC-RS2) 1.1m (IAC-RS1) 1.0m (IAC-R7□) ¹						
Adjustable Sensing Range	—				40 to 200 mm with laser: 40-300mm	—	—	
Detectable Object	Opaque		Opaque/Transparent		Opaque	Opaque/ Transparent	Opaque, transparent and mirror-like objects	
Hysteresis	—			20% maximum	10% maximum	20% maximum	—	
Response Time	1 ms maximum with laser: 250us						500 μs maximum	
Sensitivity Adjustment	Adjustable using a potentiometer (approx. 260°) Through-beam type and polarized retroreflective type are also available without sensitivity adjustment. Laser models: 2 turn adjustment				—	Adjustable using a potentiometer (approx. 260°)	Adjustable using a potentiometer (approx. 240°)	
Sensing Range Adjustment	—				6-turn control knob	—	—	
Light Source Element	Infrared LED Red LED Red laser diode	Red LED Red laser diode	Infrared LED	Red LED	Red LED Red laser diode	Infrared LED	Red LED	
Operation Mode	Light ON/Dark ON							
Control Output	NPN open collector or PNP open collector 30V DC, 100 mA maximum Voltage drop: 1.2V maximum (BGS type: 2V maximum) Short-circuit protection							
LED Indicators	Operation LED: Yellow Stable LED: Green Power LED: Green (Through-beam type projector)				Operation LED: Yellow Stable LED: None	Operation LED: Yellow Stable LED: Green	Operation LED: Yellow Stable LED: None	
Interference Prevention	— Two units can be mounted in close proximity.							
Degree of Protection	IP67 (IEC 60529)							
Extraneous Light Immunity	Sunlight: 10,000 lux maximum, Incandescent lamp: 5,000 lux maximum (at receiver)							
Operating Temperature	-25 to +55°C (no freezing)							
Operating Humidity	35 to 85% RH (no condensation)							
Storage Temperature	-40 to +70°C (no freezing)							
Insulation Resistance	Between live part and mounting bracket: 20 MΩ maximum (500V DC megger)							

Specifications, con't

Sensing Method	Through-beam	Polarized Retroreflective	Diffuse-reflective	Small-beam Reflective	Background Suppression (BGS)	Convergent Reflective	Transparent
Part No.	SA1E-T	SA1E-P	SA1E-D	SA1E-N	SA1E-B	SA1E-G	SA1E-X
Dielectric Strength	Between live part and mounting bracket: 1000V AC, 50/60 Hz, 1 minute						
Vibration Resistance	Damage limits: 10 to 55 Hz, Amplitude 0.75 mm, 20 cycles in each of 3 axes						
Shock Resistance	Damage limits: 500 m/s ² , 10 shocks in each of 3 axes						
Material	Housing: PC/PBT, Lens: PC (Polarized retroreflective / coaxial polarized retro-reflective: PMMA), Indicator cover: PC						
Attachments	Instruction sheet						
Weight (approx.)	Cable Model	Projector: 30g Laser Projector: 35g Receiver: 30g ² Laser Receiver: 35g	30g ² with laser: 35g		35g ³	30g ²	35g ³
	Connector Model	Projector: 10g Laser Projector: 20g Receiver: 10g Laser Receiver: 20g	10g with Laser 20g		20g	10g	20g
Connection Method	Cable Model	ø3.5 mm, 3-core, 0.2 mm ² , 1-m vinyl cabtyre cable (2-core for the projector of through-beam type)					
	Connector Model	M8 connector (4-pin)					



- Maintain at least the distance shown below between the SA1E photoelectric switch and reflector.
IAC-R5/R6/R7/□/R8: 100 mm
IAC-RS1/RS2: 150 mm
The detection distance cannot be guaranteed if the reflector is deformed or the tape type reflector is applied on uneven surface.
- Cable length: 1m (50g when the cable length is 2m, 55g for laser models. 110g when the cable length is 5m, 120g for laser models.)
- Cable length: 1m (55g when the cable length is 2m. 120g when the cable length is 5m.)
- For laser models insert L in place of □.

Slit and Sensing Range

A slit, which changes the beam size of through-beam sensors, can easily be attached to the sensing side of the through-beam projector and receiver. Three different slit widths are available.

Slit		w/Sensitivity Adjustment				w/o Sensitivity Adjustment			
		Sensing Range (m)		Minimum Detectable Object Width (mm)		Sensing Range (m)		Minimum Detectable Object Width (mm)	
Part No.	Slit Width: A	Used on one side	Used on both sides	Used on one side	Used on both sides	Used on one side	Used on both sides	Used on one side	Used on both sides
SA9Z-S06	0.5 mm	2.5	1.0	7.0	0.5	5.0	1.5	7.0	0.5
SA9Z-S07	1.0 mm	3.5	1.5	7.0	1.0	7.0	3.0	7.0	1.0
SA9Z-S08	2.0 mm	6.0	3.5	7.0	2.0	9.0	5.5	7.0	2.0
SA9Z-S09	0.5 mm	2.0	0.7	7.0	0.4	4.0	1.5	7.0	0.5
SA9Z-S10	1.0 mm	3.0	1.5	7.0	0.7	7.0	2.5	7.0	0.8
SA9Z-S11	2.0 mm	5.5	3.0	7.0	1.5	9.0	5.0	7.0	1.5
SA9Z-S12	0.5 mm	0.8	0.08	5.0	0.3	1.3	0.1	5.0	0.5
SA9Z-S13	1.0 mm	1.5	0.3	5.0	0.6	2.5	0.3	5.0	0.6
SA9Z-S14	2.0 mm	2.5	1.2	5.0	1.5	5.5	1.6	5.0	1.7



Used on one side: Slit is attached to the receiver only.

The slit can be pressed to snap onto the front easily.

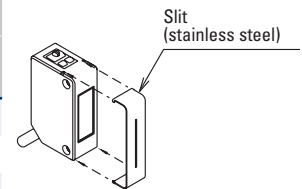

Horizontal slits and round slits have an orientation. Make sure that the TOP marking comes on top of the sensor (LED side).

Output Circuit & Wiring Diagram

NPN Output

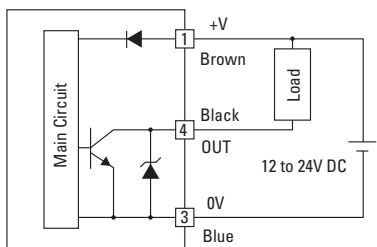

PNP Output

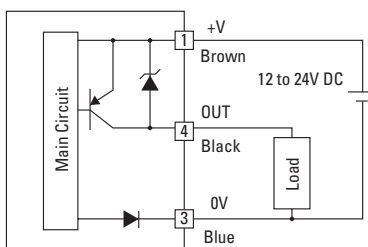

Through-beam Type Projector

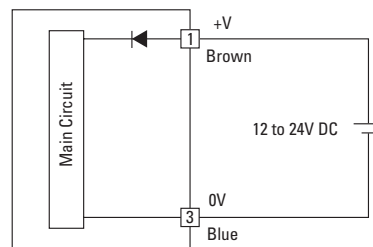

(Connector Pin Assignment)

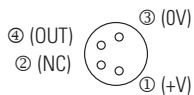

(Connector Pin Assignment)

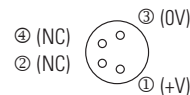

Dimensions (mm)

Vertical Slit

SA9Z-S06
SA9Z-S07
SA9Z-S08

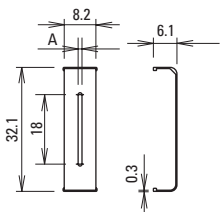

Horizontal Slit

SA9Z-S09
SA9Z-S10
SA9Z-S11

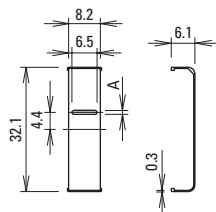

Round Slit

SA9Z-S12
SA9Z-S13
SA9Z-S14

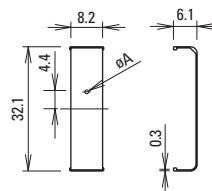

Material: Stainless Steel

Cable Model

Through-beam

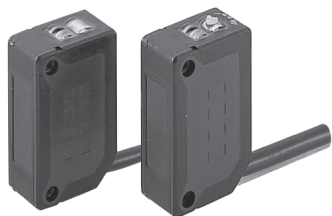

Polarized retroreflective
Diffuse-reflective
Small-beam reflective
Convergent reflective



• Through-beam

- Polarized retroreflective
- Diffuse-reflective
- Small-beam reflective
- Convergent Reflective

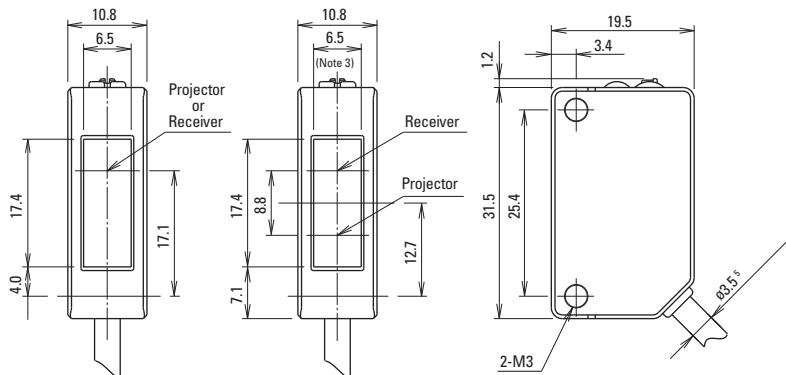
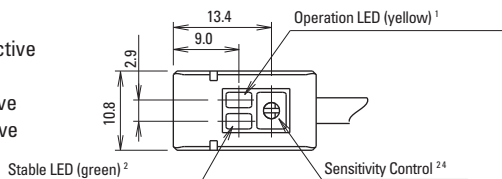

1. Power ON LED (green) for through-beam projector
2. No sensitivity control and stable LED are attached on the through-beam projector.
3. 5.2 mm for polarized retroreflective type
4. No sensitivity control is installed on the type without sensitivity adjustment.

01 Touchscreens

Cable Model

Background Suppression (BGS)

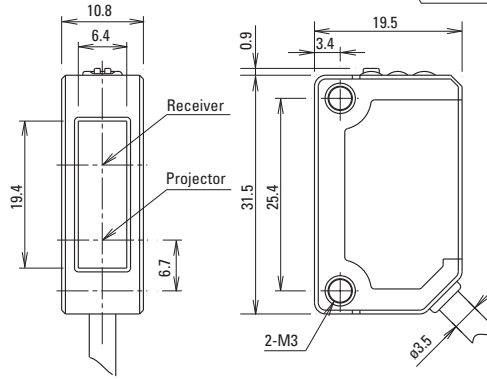
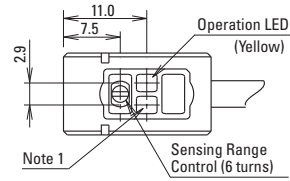

PLCs



1. Stable LED is not provided on the background suppression type.

Automation Software

Cable Model

Coaxial Polarized Retro-reflective

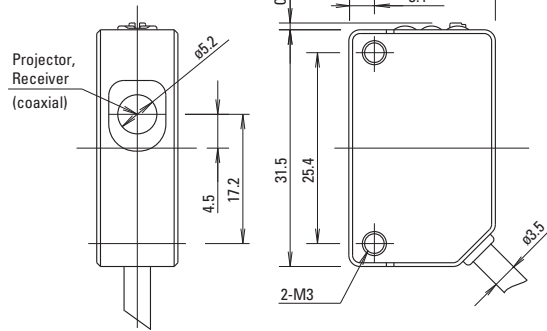
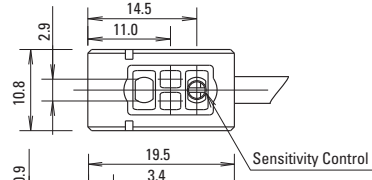

Power Supplies



1. Stable LED is not provided on the coaxial polarized retro-reflective type.

Sensors

Cable Model (Laser)

Through-beam
Polarized Retroreflective
Background Suppression

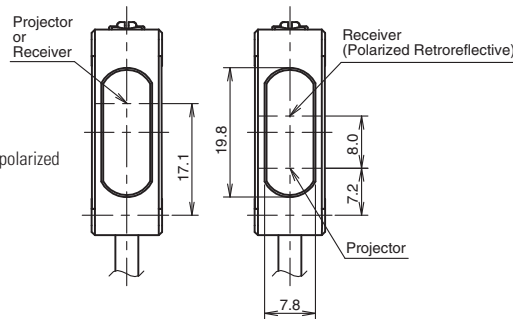
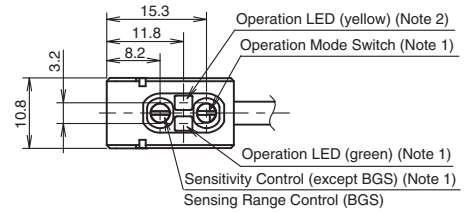

Communication



1. Stable LED is not provided on the coaxial polarized retro-reflective type.

Barriers

Connector Model

Through-beam



Polarized retroreflective
Diffuse-reflective
Small-beam reflective
Convergent reflective



- Through-beam
- Polarized retroreflective
- Diffuse-reflective
- Small-beam reflective
- Convergent Reflective

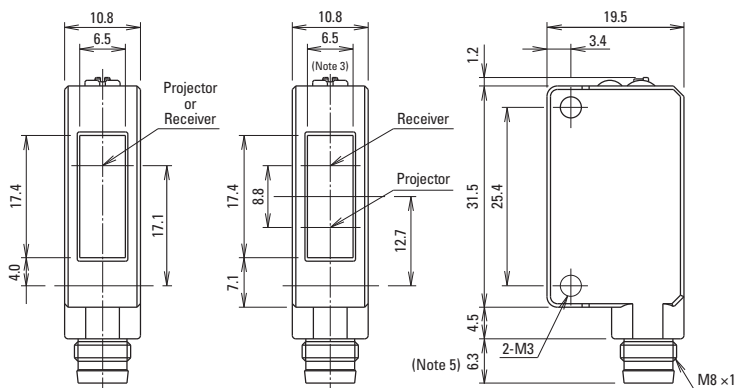

- 1. Power ON LED (green) for through-beam projector
- 2. No sensitivity control and stable LED are attached on the through-beam projector.
- 3. 5.2 mm for polarized retroreflective type
- 4. No sensitivity control is installed on the type without sensitivity adjustment.

Connector Model

Background Suppression (BGS)



- 1. Stable LED is not provided on the background suppression type.
- 2. The connector length is 18 mm when a right-angle connector cable.

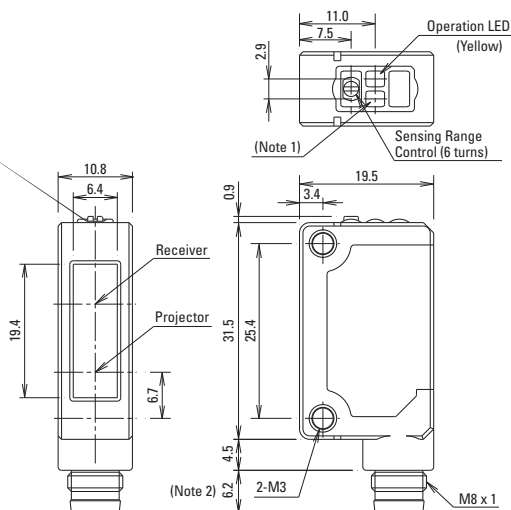

Connector Model

Coaxial Polarized Retro-reflective



- 1. Stable LED is not provided on the coaxial polarized retro-reflective type.

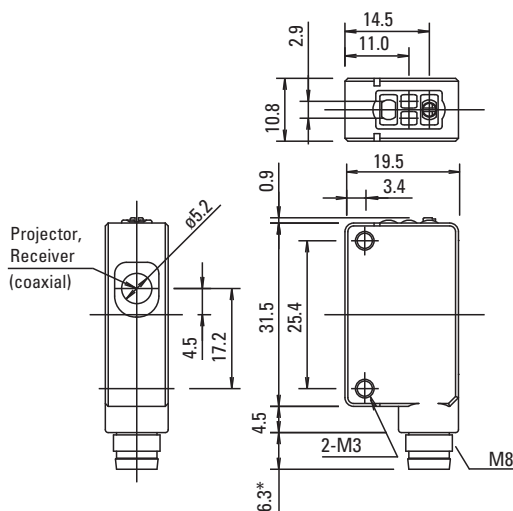

Connector Model (Laser)

Through-beam
Polarized Retroreflective
Background Suppression

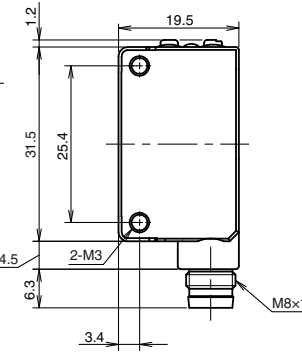
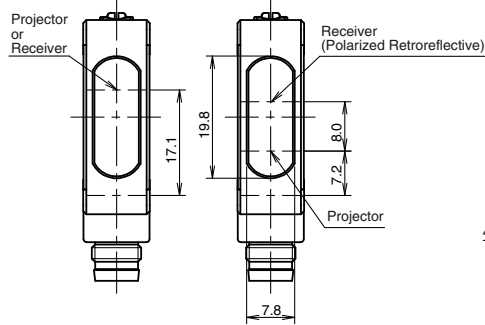
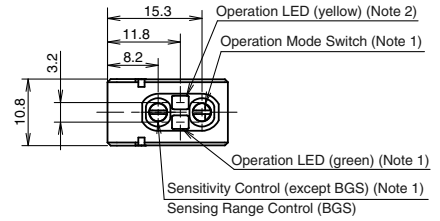

1. Stable LED is not provided on the coaxial polarized retro-reflective type.

1-1. Through-beam SA1E-T (Infrared LED w/sensitivity adjustment)
SA1E-TA (Red LED) w/sensitivity adjustment

Excess Gain (Without slit)

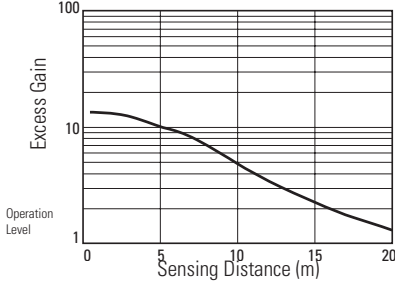

Lateral Displacement (Without slit)

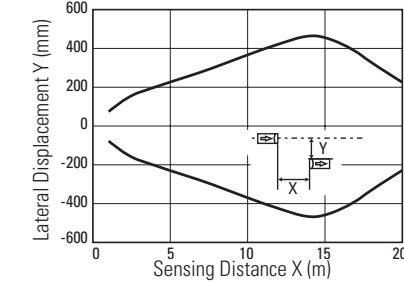

Angle (Without slit)

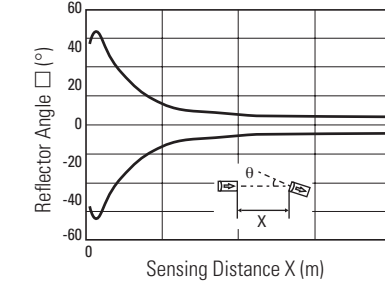

Excess Gain (With vertical slit)

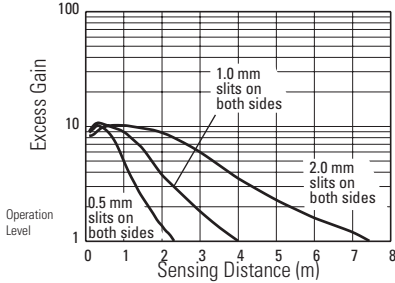

Excess Gain (With horizontal slit)

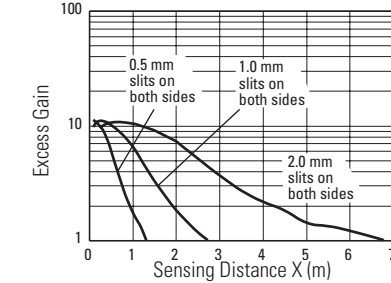

Excess Gain (With round slit)

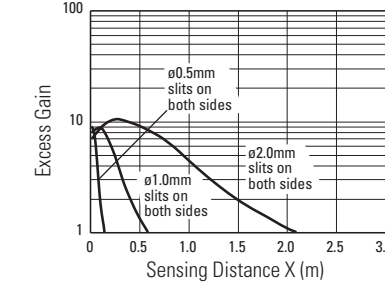

Lateral Displacement (With 0.5-mm vertical slit)

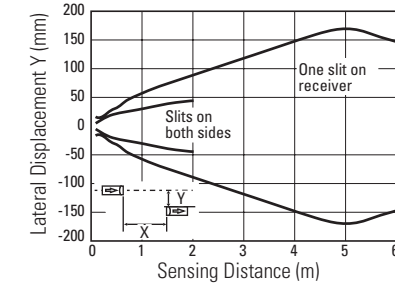

Lateral Displacement (With 1.0-mm vertical slit)

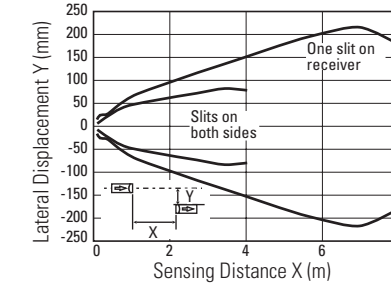

Lateral Displacement (With 2.0-mm vertical slit)

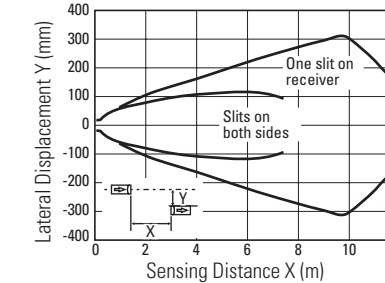

OT Touchscreens

PLCs

Automation Software

Power Supplies

Sensors

Communication

Barriers

Characteristics (Typical)

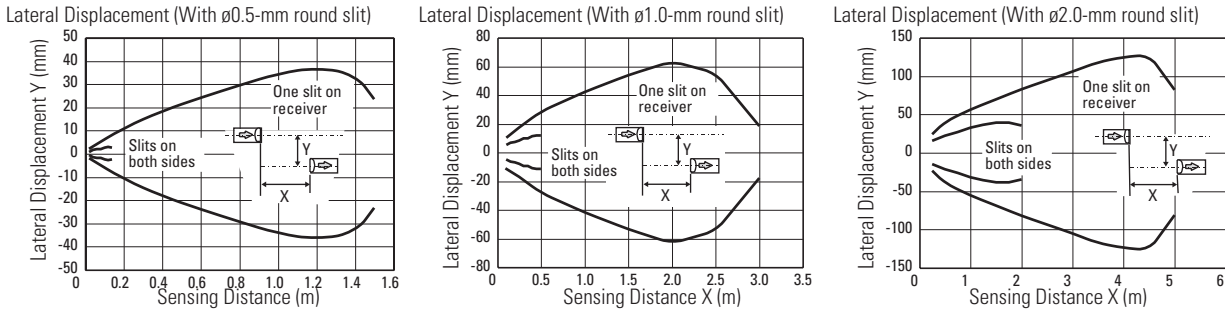
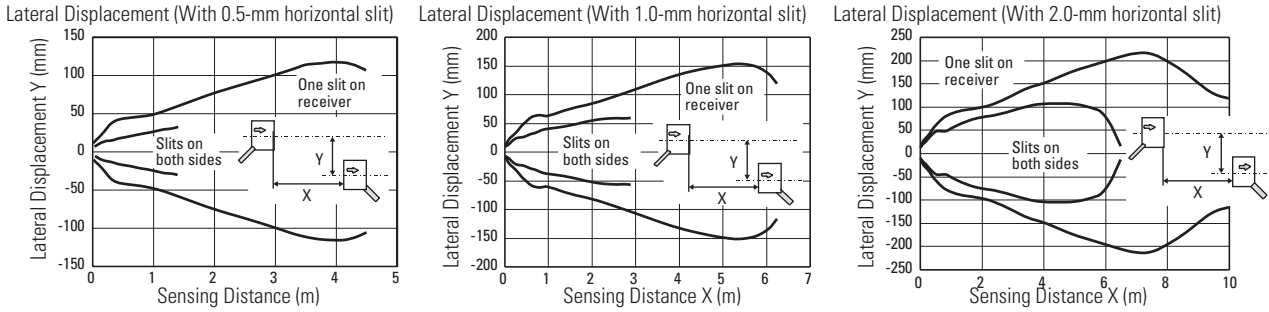

1-2. Through-beam SA1E-TC-NA (Infrared LED w/o sensitivity adjustment)

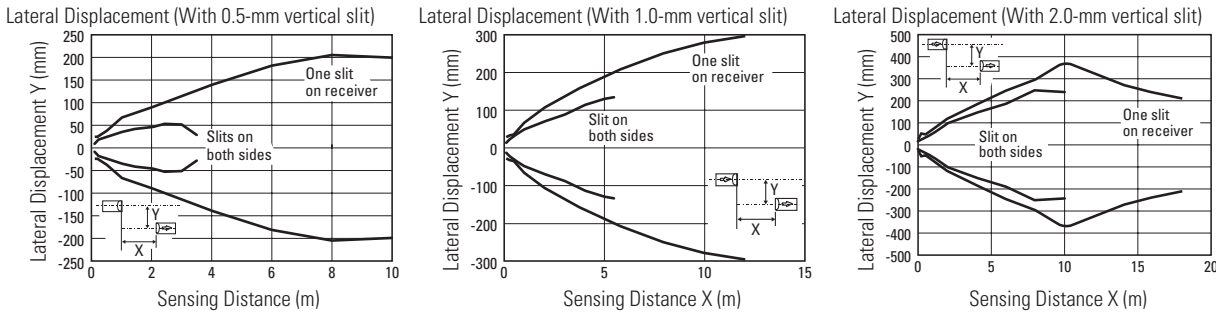
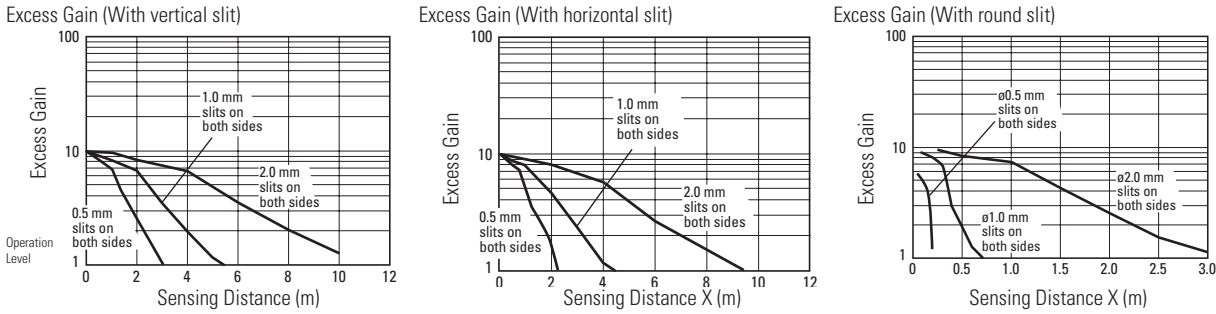
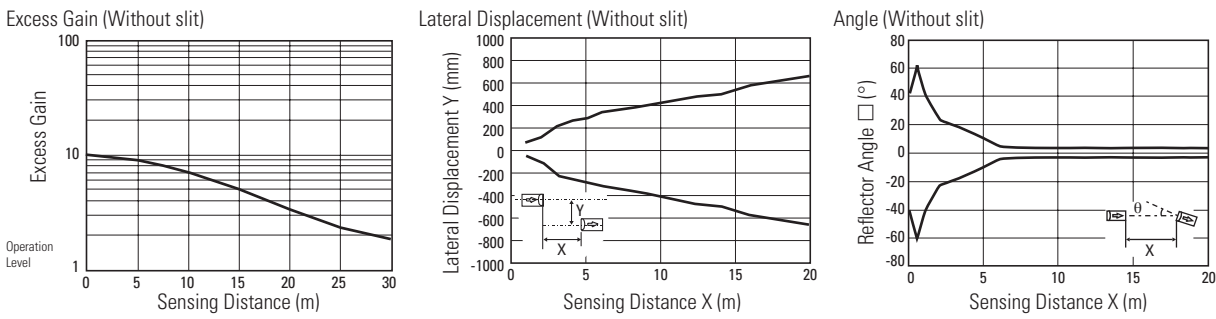

OT Touchscreens

PLCs

Automation Software

Power Supplies

Sensors

Communication

Barriers

Characteristics (Typical)

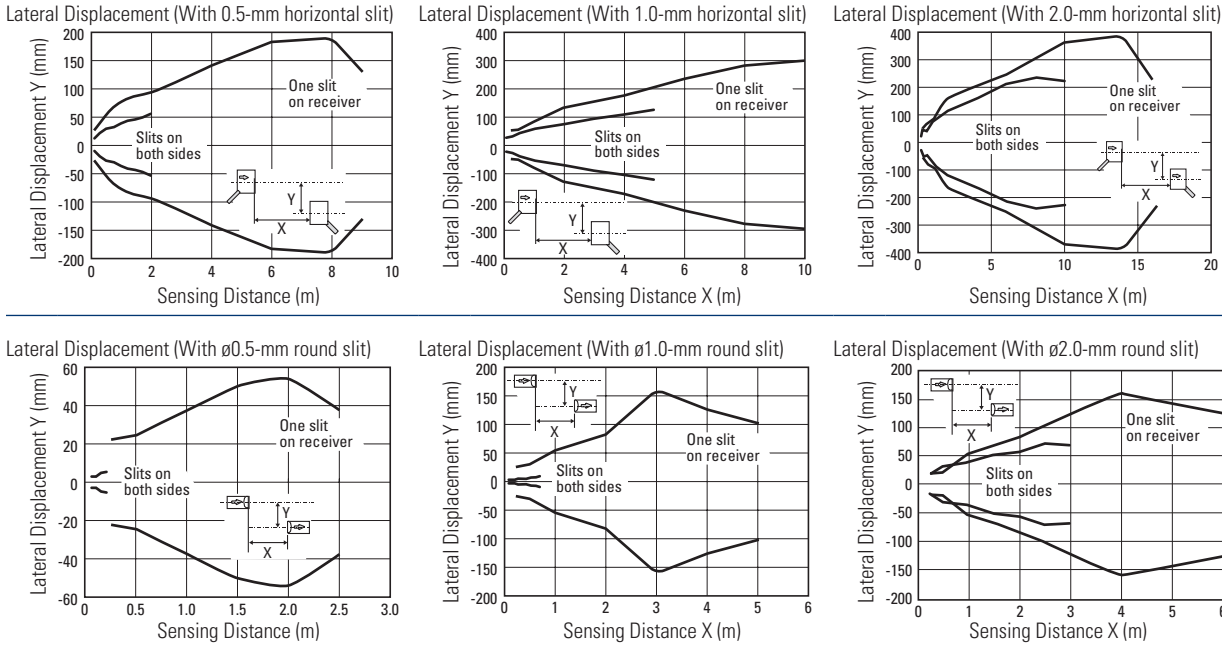

2-1. Polarized Retroreflective SA1E-P (Red LED w/sensitivity adjustment)

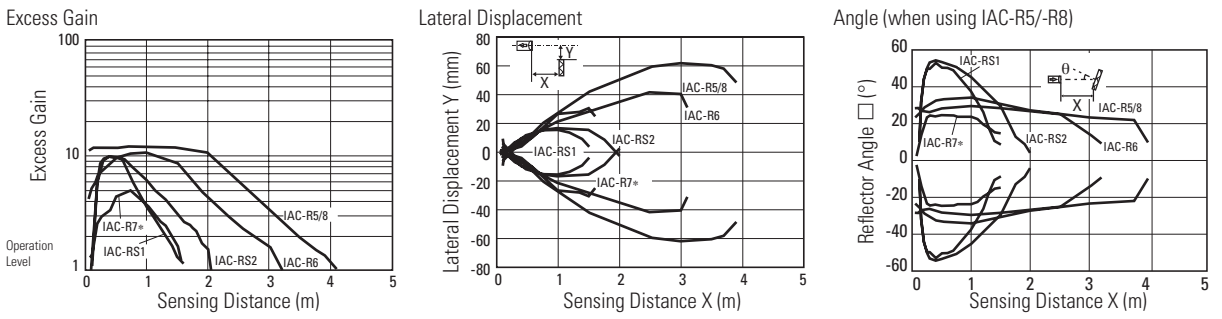

2-2. Polarized Retroreflective SA1E-PC-NA (Red LED w/o sensitivity adjustment)

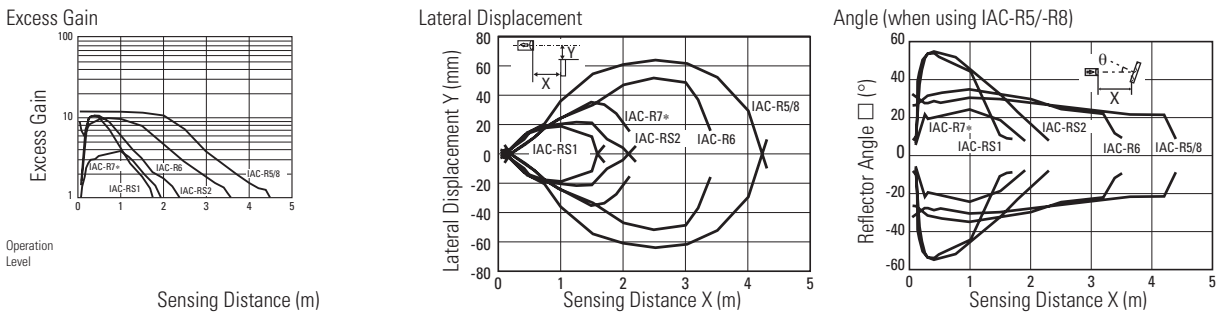

01 Touchscreens

PLCs

Automation Software

Power Supplies

Sensors

Communication

Barriers

Characteristics (Typical)

3. Diffuse-Reflective SA1E-D (Infrared LED w/sensitivity adjustment)

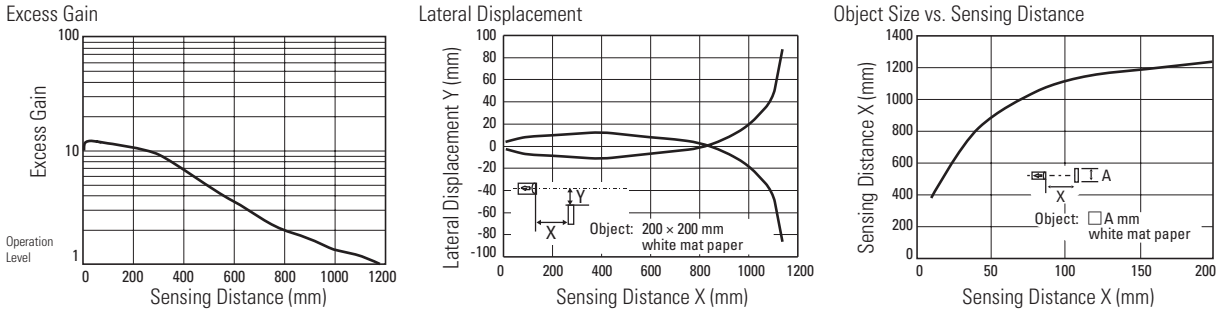

4. Small-beam Reflective SA1E-N (Red LED w/sensitivity adjustment)

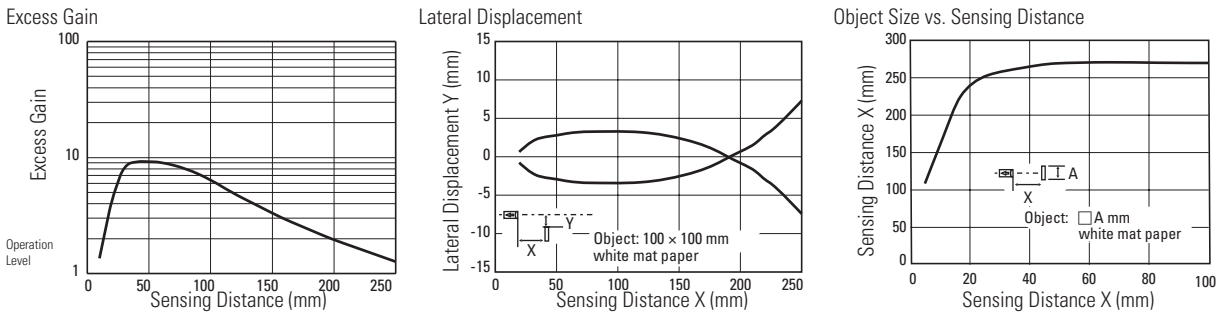

5. Background Suppression SA1E-B (Red LED w/sensitivity adjustment)

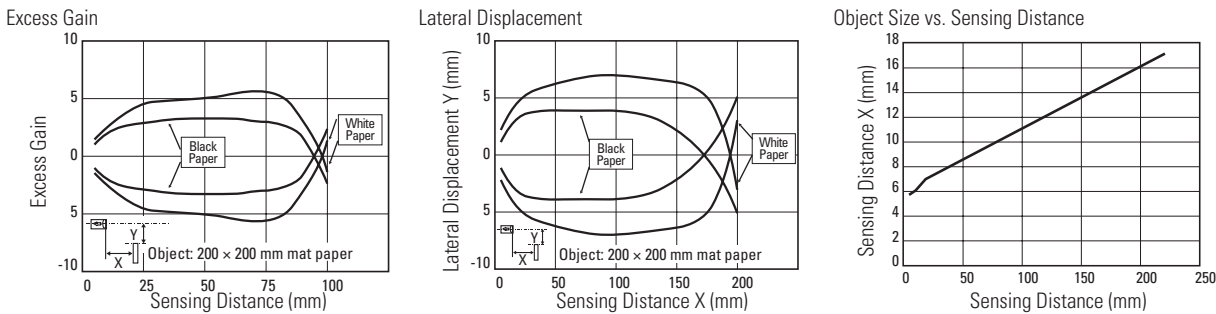

Sensing Distance vs. Hysteresis

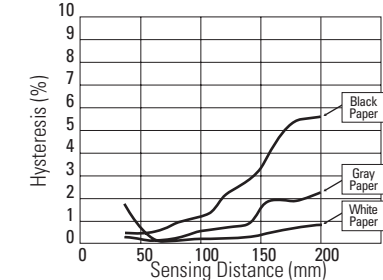

Control Knob vs. Sensing Distance

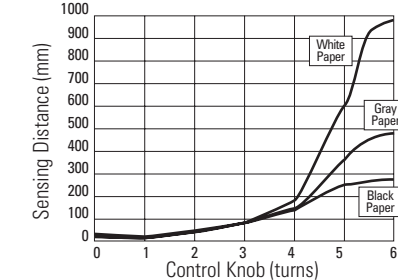

Color Mat Paper and Other Materials

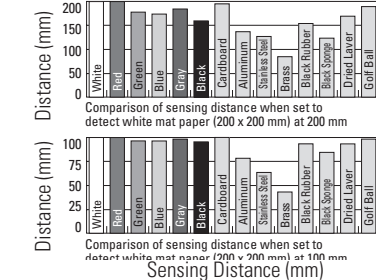

OT Touchscreens

PLCs

Automation Software

Power Supplies

Sensors

Communication

Barriers

Characteristics (Typical)

6. Convergent Reflective SA1E-G (Infrared LED w/sensitivity adjustment)

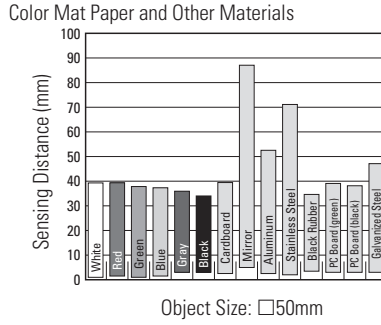
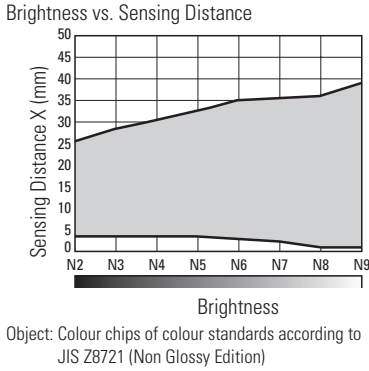
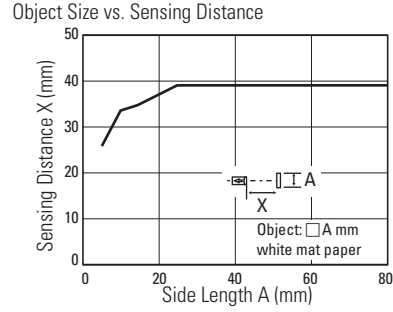
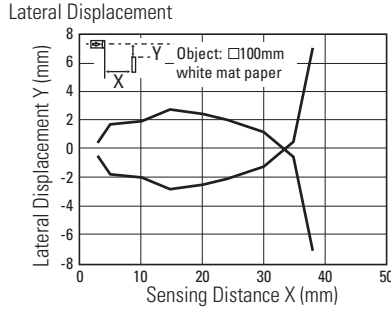
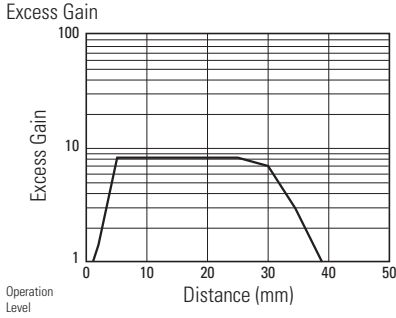

- The graph on the left shows the sensing distances for different colors and materials and can be used as a reference when setting the distance. Because sensing distance depends on the object's size and surface condition, provide a sufficient distance.
- Note that sensing may be affected by reflective object behind the sensing object.
- Referring to the graph on the left, provide a sufficient distance between the photoelectric switch and background.

7. Coaxial Polarized Retro-reflective SA1E-X

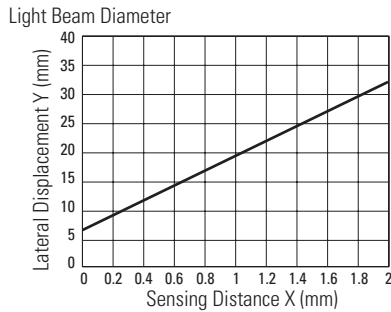
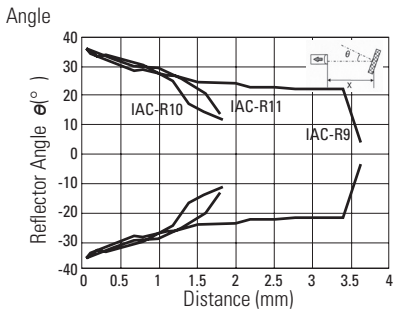
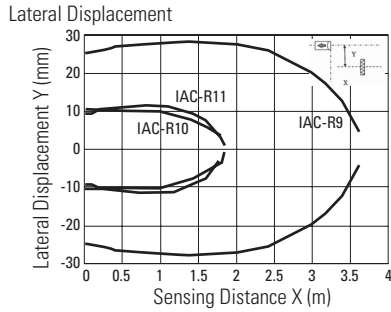
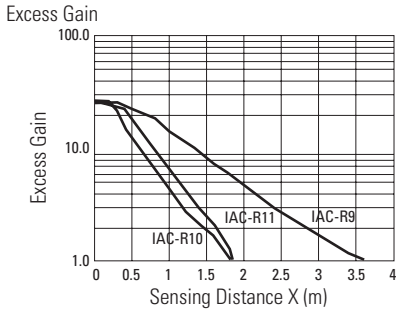

01 Touchscreens

PLCs

Automation Software

Power Supplies

Sensors

Communication

Barriers

Safety Precautions

Turn off power to the SA1E Miniature Photoelectric Switches before installation, removal, wiring, maintenance, and inspection. Failure to turn power off may cause electrical shock or fire hazard.

Instructions

1. Indicator and Output Operation

(except for background suppression type)

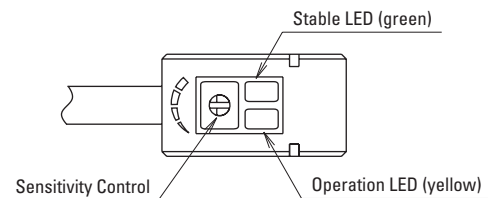

- The operation LED turns on (yellow) when the control output is on.
- The stable LED turns on (green) either at stable incident or stable interruption. Make sure to use the photoelectric switch after the stable operation is ensured.
- In the light ON operation, the output turns on when the receiving light intensity level is 1.0 or over as shown on the right.
- In the dark-ON operation, the output turns on when the receiving light intensity level is 1.0 or less as shown on the right.

2. Optical Axis Alignment (Light ON)

Through-beam

Fasten the receiver temporarily. Place the projector to face the receiver. Move the projector up, down, right and left to find the range where the operation LED turns on. Fasten the projector in the middle of the range. Next, move the receiver up, down, right and left in the same manner and fasten in the middle of the range where the operation LED turns on. Make sure that stable LED turns on at stable incident and stable interruption.

Polarized retroreflective

Install the reflector perpendicularly to the optical axis. Move the SA1E photoelectric switch up, down, right and left to find the range where the operation LED turns on. Fasten the switch in the middle of the range. Polarized retroreflective type can be installed also by finding the position where the reflection of projected red light is most intense, while observing the reflection on the reflector from behind the switch. Make sure that stable LED turns on at stable incident and stable interruption.

Operation Level	1.2 and over	Stable Incident	ON	ON	OFF
	1.0	Unstable Incident	OFF	OFF	ON
		Unstable Interruption	ON	OFF	ON
0.8 and below	Stable Interruption	ON	ON	ON	ON

Diffuse-reflective/Small-beam reflective/Convergent reflective

Place the SA1E photoelectric switch where the switch can detect the object. Move the switch up, down, right and left to find the range where the operation LED turns on. Fasten the switch in the middle of the range. Make sure that stable LED turns on at stable incident and stable interruption. Because the light source element of small-beam reflective type is a red LED, visual inspection is possible as well.

3. Sensitivity Adjustment

- Referring to the table to the right, adjust the sensitivity of the SA1E photoelectric switch when necessary, in such cases as the through-beam type is used to detect small or translucent objects or the reflective type is affected by background. The table explains the status of operation LED when the operation mode is set to light ON.
- After adjusting the sensitivity, make sure that stable LED turns on at stable incident and stable interruption. For detecting objects too small to turn on the stable LED, use an optional slit.
- Sensitivity is set to the maximum at the factory before shipment. When adjusting the sensitivity, use the screwdriver supplied with the SA1E photoelectric switch to turn the control as shown below, to a torque of 0.05 N·m maximum.

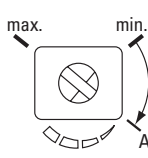
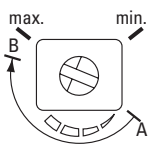
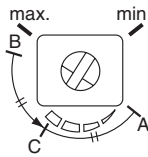
Step	Photoelectric Switch Status	Sensitivity Control	Adjusting Procedure
1	Receiving light <ul style="list-style-type: none"> Through-beam, polarized reflective: No object detected Diffuse reflective, small-beam reflective, convergent reflective: Object detected 		Turn the control counter-clockwise to the minimum. Then turn clockwise until the operation LED turns on (turns off with dark ON type) (point A).
2	Light is interrupted <ul style="list-style-type: none"> Through-beam, polarized reflective: Object detected Diffuse reflective, small-beam reflective, convergent reflective: No object detected 		At interruption status, turn the control clockwise from point A, until the operation LED turns on (turns off with dark ON type) (point B). If the operation LED does not turn on (turn off with dark ON type) even though the control has reached the maximum, set the maximum position as point B.
3	—		Set the middle point between point A and B as point C.

4. Adjustment of Sensing Range for Background Suppression (BGS) Type

- When adjusting the sensing range, follow the instructions below.

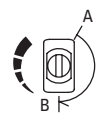
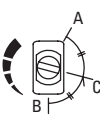
Step	Distance Control	Adjusting Procedure
1		Turn the control counter-clockwise to the minimum. Then turn clockwise until the operation LED turns on (turns off with dark ON type) (point A).
2		At interruption status, turn the control clockwise from point A, until the operation LED turns on (turns off with dark ON type) (point B). If the operation LED does not turn on (turn off with dark ON type) even though the control has reached the maximum, set the maximum position as point B.
3		Set the middle point between point A and B as point C.

- When the background is far off and not detected, turn the control 360°, and set the point as point C.
- Because the control is multi-turn, it may take more than one turn to move from point A to point B.

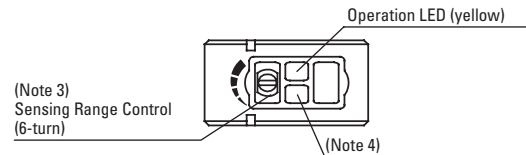

- Turning the control clockwise lengthens the sensing distance.
- Background suppression (BGS) type is not provided with a stable LED.

5. Power Supply and Wiring

- Do not use the SA1E photoelectric switch at the transient status immediately after turning on the power (approx. 100 ms, background suppression type: 200 ms). When the load and switch use different power supplies, make sure to power up the switch first.
- Use a power supply with little noise and inrush current, and use the photoelectric switch within the rated voltage range. Make sure that ripple factor is within the allowable limit. Do not apply AC voltage, otherwise the switch may blow out or burn.
- When using a switching power supply, make sure to ground the FG (frame ground) terminal, otherwise high-frequency noise may affect the photoelectric switch.
- Turn power off before inserting/removing the connector on photoelectric switch. Make sure that excessive mechanical force is not applied to the connector. Connect the connector cable to a tightening torque of 0.5 N·m maximum.
- To ensure the degree of protection, use the applicable connector cable for the connector type. Connector cables are ordered separately.
- Avoid parallel wiring with high-voltage or power lines in the same conduit, otherwise noise may cause malfunction and damage. When wiring is long, use a separate conduit for wiring.
- Use a cable of 0.3 mm² minimum core wires, then the cable can be extended up to 100m.