



## Features

- Formerly a **KOMATSULITE™** product
- Miniature Thermal Cutoff (TCO) device
- Surface mount
- Overtemperature and overcurrent protection for lithium polymer and prismatic cells
- Controls abnormal, excessive current virtually instantaneously, up to rated limits
- Wide range of temperature options

## Applications

Battery cell protection for:

- Notebook PCs
- Tablet PCs
- Smartphones
- USB cable protection for smart phones

## SA Series Breaker (Surface Mount Thermal Cutoff Device)

### Ratings

Specification	SA72SB0	SA77SB0	SA82SB0	SA85SB0
Trip Temperature	72 °C ± 5 °C	77 °C ± 5 °C	82 °C ± 5 °C	85 °C ± 5 °C
Reset Temperature	40 °C min.			
Contact Rating	DC9 V / 25 A, 6000 cycles			
Maximum Breaking Current	DC5 V / 60 A, 100 cycles			
Maximum Voltage	DC28 V / 25 A, 100 cycles			
Minimum Holding Voltage	3 V @ 25 °C for 1 minute			
Maximum Leakage Current	200 mA max. @ 25 °C			
Resistance	7 milliohms max.			

Mini-breaker TCOs reset when the following conditions are met:

- The ambient temperature has dropped by 10 °C below the minimum trip temperature
- Power to the TCO has been cycled (off/on)

### Agency Recognition

Description	
UL, cUL	File Number: E215638 (UL 60730)
TÜV	File Number: E50373669 (EN60730-2-9)

### How to Order

SA 77 S B 0

Series Designator \_\_\_\_\_

Trip Temperature (±5 °C) \_\_\_\_\_

- 72
- 77
- 82
- 85

Arm Material \_\_\_\_\_

S = Cu Alloy High Current Type

Terminal Type \_\_\_\_\_

B = 4 Terminals  
(Terminal Length 1.3 mm)

Special Specification Code \_\_\_\_\_

Resin Type, Mfg. Internal Code, Design Mark, etc.

### Additional Information

Click these links for more information:



**WARNING Cancer and Reproductive Harm - [www.P65Warnings.ca.gov](http://www.P65Warnings.ca.gov)**

\* RoHS Directive 2015/863, Mar 31, 2015 and Annex.

\*\* Bourns considers a product to be "halogen free" if (a) the Bromine (Br) content is 900 ppm or less; (b) the Chlorine (Cl) content is 900 ppm or less; and (c) the total Bromine (Br) and Chlorine (Cl) content is 1500 ppm or less.

Specifications are subject to change without notice.

Users should verify actual device performance in their specific applications.

The products described herein and this document are subject to specific legal disclaimers as set forth on the last page of this document, and at [www.bourns.com/docs/legal/disclaimer.pdf](http://www.bourns.com/docs/legal/disclaimer.pdf).

# SA Series Breaker (Surface Mount Thermal Cutoff Device)

**BOURNS®**

## Product Dimensions

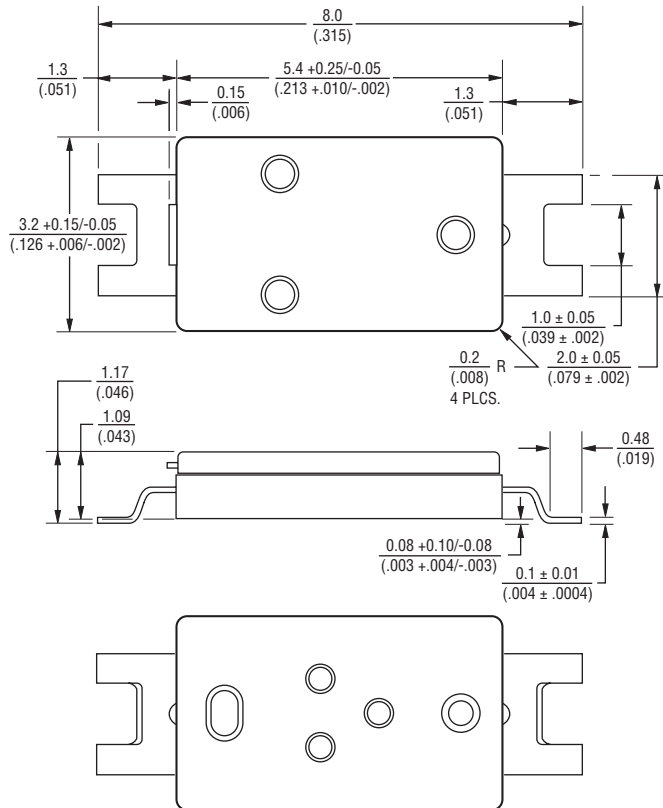

DIMENSIONS:  $\frac{\text{MM}}{\text{(INCHES)}}$

## Product Structure

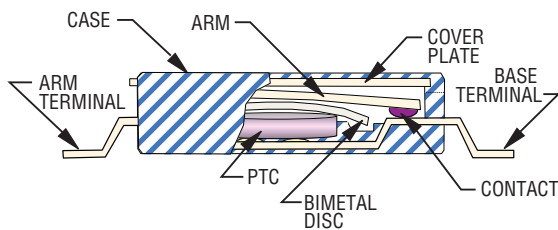

## Circuit Diagram

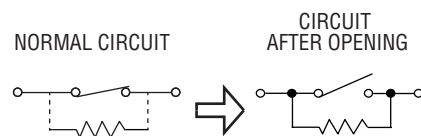

Specifications are subject to change without notice.

Users should verify actual device performance in their specific applications.

The products described herein and this document are subject to specific legal disclaimers as set forth on the last page of this document, and at [www.bourns.com/docs/legal/disclaimer.pdf](http://www.bourns.com/docs/legal/disclaimer.pdf).

Typical Performance

Current vs. Temperature Curves

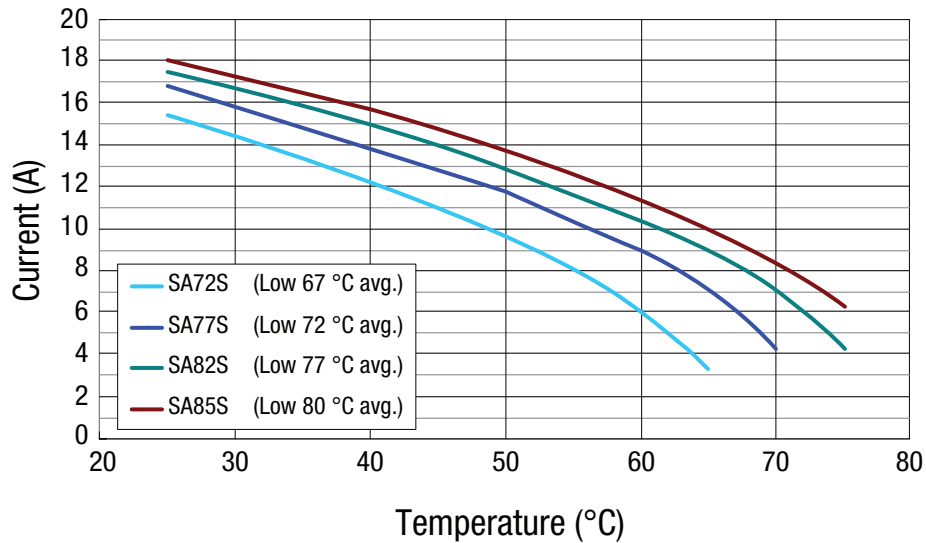

The above curves were derived from placing non-PCB mounted test samples in an oven at 25 °C, 40 °C, 60 °C, and 70 °C, increasing current flow through the sample at a rate of 0.1 A/minute and recording the current value when the sample trips. The current carrying performance is influenced by the PCB design due to copper resistance; users should verify actual device performance in their specific applications.

# SA Series Breaker (Surface Mount Thermal Cutoff Device)



## Surface Mount Recommendations

The Model SA Series breaker is designed for reflow and hand soldering. It is not designed or warranted for flow soldering. The following conditions must be adhered to:

### Reflow Soldering:

The recommended reflow soldering conditions are as follows:

150 ~ 180 °C .....	100 ~ 150 seconds
≤220 °C .....	20 ~ 40 seconds
255 ~ 260 °C .....	5 ~ 10 seconds

Process breaker in a reflow furnace using the profile shown above three times, followed by positioning the breaker in ambient temperature of +25 °C for 8 hours.

### Hand Soldering:

Place a solder iron on each of the terminal ends for 5 seconds at +350 °C, followed by positioning the breaker in ambient temperature of +25 °C for 8 hours.

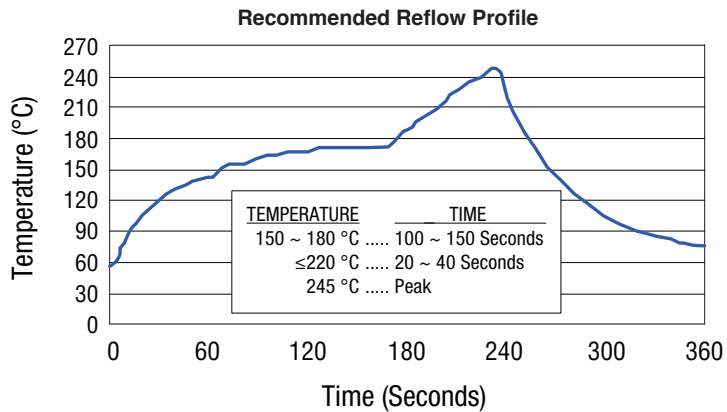

**Do not expose the breaker to temperatures exceeding +260 °C.**

## Recommended Land Pattern

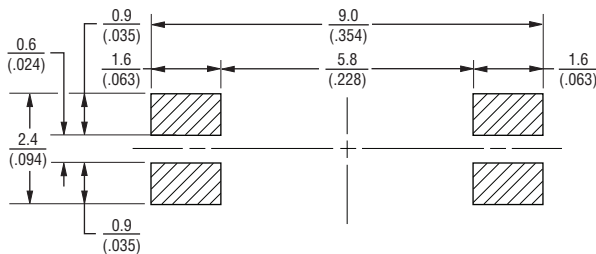

Recommended Mask Thickness: 0.12 mm

Recommended Solder Particle Size: 30 μm

DIMENSIONS:  $\frac{\text{MM}}{\text{(INCHES)}}$

## Mounting Cautions

In order to protect the housing and mechanical parts inside from deformation, prevent excessive load at the time of part absorption / part deployment and mounting. A part absorption nozzle more than 2 mm in diameter with a 3 N (5 N max.) mounting load is recommended. Any shock to the product by the nozzle during the mounting procedure may have a negative influence on the function of the breaker.

Specifications are subject to change without notice.

Users should verify actual device performance in their specific applications.

The products described herein and this document are subject to specific legal disclaimers as set forth on the last page of this document, and at [www.bourns.com/docs/legal/disclaimer.pdf](http://www.bourns.com/docs/legal/disclaimer.pdf).

# SA Series Breaker (Surface Mount Thermal Cutoff Device)

**BOURNS®**

## Standard Packaging Specifications

Reel (13 inch) .....5,000 pcs. (fixed)  
 Outer Box (690 mm x 344 mm x 136 mm) .....50,000 pcs. (fixed)  
 Marking.....A label will be attached on the reel and outer box which includes the following items, at a minimum:  
 Part name, part number, quantity, lot number, safety approval mark (UL, etc.),  
 company name (Bourns KK) and any other items required by the customer

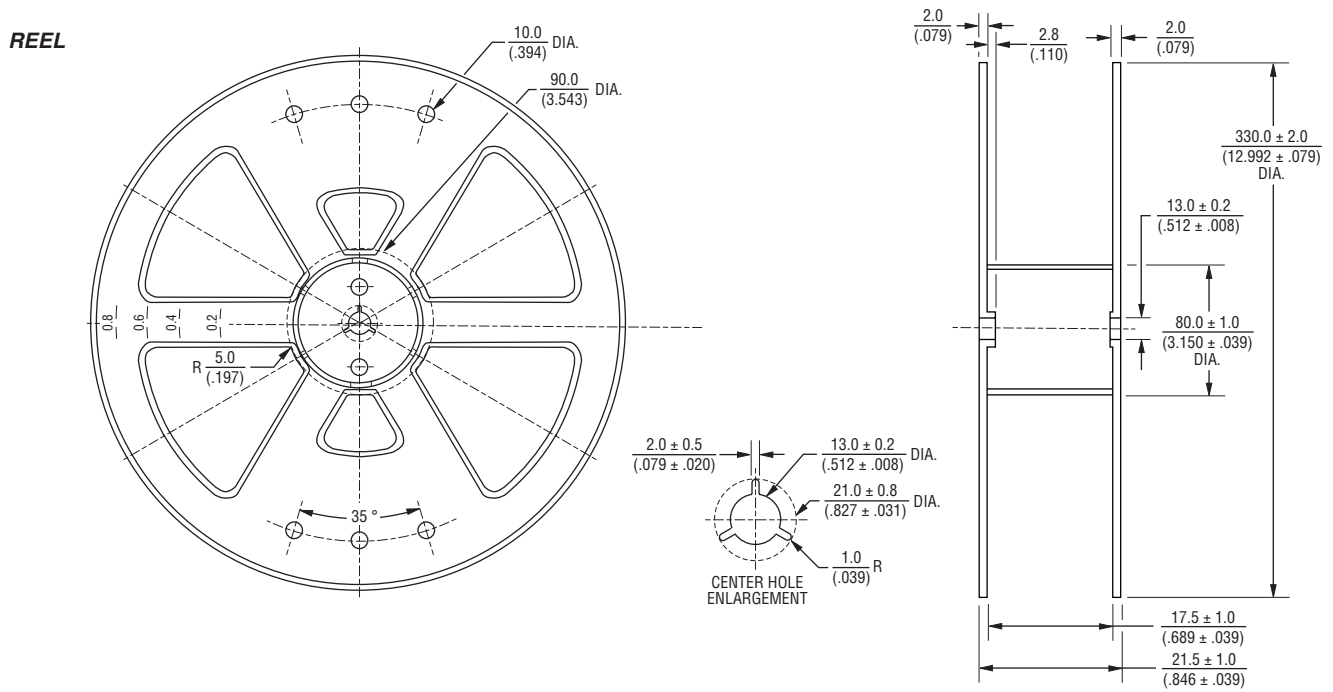

## CARRIER TAPE

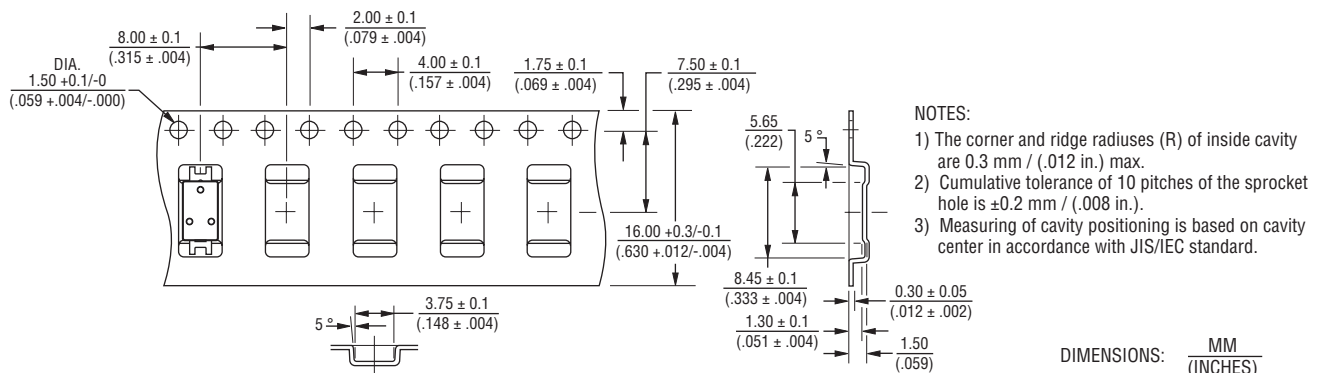

# SA Series Breaker (Surface Mount Thermal Cutoff Device)



## Typical Part Marking

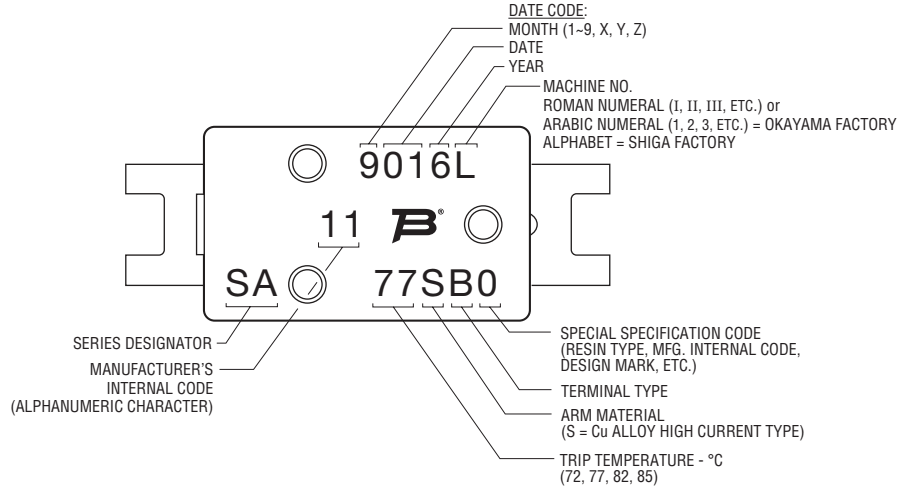

## Application Temperature Range

..... -30 ~ 100 °C

## Storage Conditions

- 1) The breaker must be stored in the standard packaging with the following conditions: ambient temperature of -10 to +40 °C, RH <75 % with no radical temperature change, direct sunshine, excessive vibration or shock.
- 2) Avoid storage locations where there is a possibility of generating corrosive gas such as from salt breeze, chlorine, hydrogen sulfide, ammonium, sulfide-oxidation, hydrogen chloride, acetate, etc.
- 3) Storage period should be no longer than 24 months from date of shipment.

Specifications are subject to change without notice.

Users should verify actual device performance in their specific applications.

The products described herein and this document are subject to specific legal disclaimers as set forth on the last page of this document, and at [www.bourns.com/docs/legal/disclaimer.pdf](http://www.bourns.com/docs/legal/disclaimer.pdf).

## Caution when using Breaker

Before using the breaker, please fully read the *DESIGN AND HANDLING CAUTIONS* stated below to avoid breaker performance deterioration and/or damage to the breaker body or terminal.

## DESIGN CAUTIONS

1. Use within the electrical ratings specified in this data sheet. If used over the rating of voltage or current, ON-OFF life might be impacted and contact may deteriorate due to breaker arm damage.
2. If used over the maximum electrical rating specified in this data sheet, the circuit may not open safely or operate properly. Please test your device for any abnormalities and confirm that the breaker will open the circuit safely in your device.
3. Mount the breaker on your device where heat is the highest in order to transfer it effectively to the breaker.
4. If the breaker is affixed with an adhesive (resin, etc.), before proceeding, fully test, evaluate and verify that the adhesive presents no negative effects on the breaker before proceeding.
5. After the breaker is mounted, affix it so that the breaker body and terminals will not move. If not affixed properly, breaker resistance could increase or contact could open due to stress during handling or vibration/shock during transportation.
6. Mount the breaker body and terminals in a straight and flat direction. If the body and terminals are mounted in a twisted condition, breaker resistance could increase or create body damage.
7. If breaker is to be resin-molded, test and evaluate the application to determine whether the breaker can be used effectively.
8. The breaker cannot be used as a repetitive ON-OFF thermostat.
9. The breaker is not washable. Do not wash.
10. Do not let a solder iron touch the breaker body.
11. Do not attach solder to the breaker body.
12. When mounting and after mounting the breaker, do not apply supersonic vibration. Vibration and heat may cause breaker resistance to increase or may cause body damage. If you plan to apply supersonic vibration after mounting the breaker, you will need to evaluate whether the breaker is suitable for your specific application. The breaker is not designed or warranted to withstand supersonic vibration.
13. Do not use the breaker in the following environments:
  - a) Water, oil, chemical or organic solutions
  - b) Direct sunlight, outdoor exposure, dust
  - c) Dew condensation, where the breaker could get wet
  - d) Salt breeze, chlorine, hydrogen sulfide, ammonium, sulfide-oxidation, hydrogen chloride, acetate and anywhere there is a possibility of generating corrosive gas such as sulfuric acid gas
  - e) Strong static electric charge or electromagnetic wave
14. The breaker is not designed or tested for, and should not be used in, aerospace, airplane, nuclear, military, life-sustaining medical and other related applications.

## Caution when using Breaker (Continued)

## HANDLING CAUTIONS

1. Since the breaker body is composed of plastic parts, do not clamp or dent with tools as this could cause a resistance increase or body damage.
2. Breaker terminals are thin copper-alloy with right angle edges. Handle carefully to avoid injury to fingers. Handling while wearing finger cots and using tweezers is recommended.
3. When mounting the breaker on a cell or PCM board, be careful to avoid placing excessive stress on the breaker body and terminals. Excessive stress may cause a resistance increase or body damage. Please refer to the following cautions:
  - a) Do not apply more than 5 N moment to the breaker body (refer to Figure 1)
  - b) Do not apply more than 1.5 cN-m twist torque to the breaker body (refer to Figure 2)
  - c) Do not apply more than 15 N bending force to the breaker body (refer to Figure 3)
  - d) Do not apply more than 0.4 cN-m twist torque to the breaker terminals (refer to Figure 4)
  - e) Do not apply more than 2 N force to the breaker terminals (refer to Figure 5)
  - f) Do not bend terminals more than 45 ° at root (refer to Figure 6)
  - g) Do not twist terminals more than 20 ° with the breaker body affixed.

