

SBT-70-G/B

LEDs

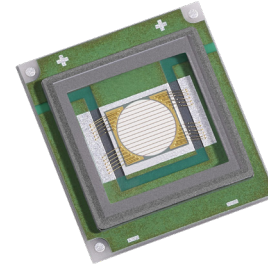

Table of Contents

Technology Overview2

Ordering Information3

Binning Structure4

Typical Device Performance.....5

Absolute Maximum Ratings6

Optical & Electrical Characteristics.....7

Angular Distribution & Typical Spectrum9

Soldering Profile 10

Mechanical Dimensions .. 11

Shipping Tray Outline 13

Shipping Label..... 14

Revision History..... 15

Features:

- Extremely high optical output from a 7 mm² circular emitter:
 - Over 2000 green lumens at 10.5 A
 - Over 200 blue lumens at 10.5 A and 445 nm
 - Refer to SBT-90-R for companion red product
- Round emitting aperture provides most efficient match to circular optical systems and narrow beam projectors
- Unencapsulated die with low profile protective window optimizes optical coupling in etendue-limited applications
- High thermal conductivity package - junction to case thermal resistance of only 0.64°C/W
- Variable drive current up to 10.5 A continuous wave. Up to 2 A/mm² in pulsed conditions
- RoHS and REACH compliant

Applications

- Architectural and Entertainment Lighting
- Fiber-coupled Illumination
- Medical Lighting
- Machine Vision
- Microscopy
- Spot Lighting

Technology Overview

Luminus LEDs™ benefit from a suite of innovations in the fields of LED die technology, packaging and thermal management. These breakthroughs allow illumination engineers and designers to achieve solutions that are high brightness and high efficiency.

Luminus Technology

Luminus' technology enables large area LED chips with uniform brightness over the entire LED chip surface. The optical power and brightness produced by these large monolithic chips enable solutions which replace arc and halogen lamps where arrays of traditional high power LEDs cannot.

Packaging Technology

Thermal management is critical in high power LED applications. With a thermal resistance from junction to case of 0.64°C/W, Luminus SBT-70 LEDs have the lowest thermal resistance of any LED on the market. This allows the LED to be driven at higher current densities while maintaining a low junction temperature, thereby resulting in brighter solutions and longer lifetimes.

Reliability

This product is sensitive to static electricity, and care should be taken when handling them. Static electricity or surge voltage will damage the LEDs. It is recommended to wear an anti-electrostatic wristband or anti-electrostatic gloves when handling the LEDs. All devices, equipment and machinery must be properly grounded. It is recommended that measures be taken to isolate LED processing equipment from potential sources of voltage surges.

Reference: APN-002815 Electrical Stress Damage to LEDs and How to Prevent It

Environmental Benefits

Luminus LEDs help reduce power consumption and the amount of hazardous waste entering the environment. All LED products manufactured by Luminus are RoHS compliant and free of hazardous materials, including lead and mercury.

Understanding Big Chip LED Test Specifications

Every Luminus LED is fully tested to ensure that it meets the high quality standards expected from Luminus' products.

Testing Temperature

Luminus surface mount LEDs are typically tested with a 20 ms single pulse and a case temperature of 25°C. Expected flux values in real world operation can be extrapolated based on the information contained within this product data sheet.

Ordering Information

The table below lists ordering part numbers available for SBT-70 LEDs. The part number includes a bin kit, a group of flux and wavelength bins described in page 4, that are shippable for a given ordering part number.

Ordering Part Numbers

Color	Luminous Flux		Wavelength Bin Code	Ordering Part Number
	Bin Code	Min. Flux (lm)		
Green	JK	1500	G4, G5, G6, G7	SBT-70-G-F75-JK200
			G4, G5	SBT-70-G-F75-JK201
			G6, G7	SBT-70-G-F75-JK202
	JM	2000	G4, G5, G6, G7	SBT-70-G-F75-JM200
			G4, G5	SBT-70-G-F75-JM201
			G6, G7	SBT-70-G-F75-JM202
Blue	DF	120	B1, B2, B3, B4	SBT-70-B-F75-KF300
			B2, B3	SBT-70-B-F75-KF301
	DG	160	B1, B2, B3, B4	SBT-70-B-F75-KG300
			B2, B3	SBT-70-B-F75-KG301

Part Number Nomenclature

SBT — 70 — <C> — F75 — <Bin kit>

Product Family	Chip Area	Color	Package Configuration	Bin kit
SBT: Surface Mount (window) SBR: mounted on an aluminum star board	7.0 mm ²	G: Green B: Blue	F75: SBT package R75: SBR package	Flux and Wavelength bin kit code - See ordering information

Note 1: Flux Bin listed is minimum bin shipped, higher bins may be included at Luminus' discretion.

SBT-70 G/B Binning Structure

SBT-70 monochromatic LEDs are tested for luminous flux and dominant wavelength at a 10.5 A (1.5 A/mm²) drive current and placed into one of the following flux and wavelength bins. The binning structure is universally applied across each monochromatic color.

Flux Bins

Color	Luminous Flux Bin (FF) ³	Binning @ 10.5 A, T _c = 25°C ⁵	
		Minimum Flux (lm)	Maximum Flux (lm)
Green	CK	1500	2000
	CM	2000	2300
	CN	2300	2600
Blue	DF	120	160
	DG	160	200
	DH	200	250
	DJ	250	350
	DK	350	450

Wavelength Bins

Color	Luminous Flux Bin (FF) ³	Binning @ 10.5 A, T _c = 25°C ⁵	
		Minimum Flux (lm)	Maximum Flux (lm)
Green	G4	520	525
	G5	525	530
	G6	530	535
	G7	535	540
Blue	B1	435	440
	B2	440	445
	B3	445	450
	B4	450	455

Note 1: Luminus maintains a +/- 6% tolerance on flux measurements.

Note 2: Products are production tested then sorted and packed by bin.

Note 3: Individual bins are not orderable. Please refer to the Product Ordering information page for a list of orderable bin kits.

Note 4: Product test condition: 10.5 A DC, 25°C constant case temperature.

Note 5: T_c = Case Temperature.

Typical Device Performance

General Characteristics		Symbol	Green	Blue	Unit
Emitting Area		A_e	7.0	7.0	mm ²
Emitting Area (Diameter)		D_e	3	3	mm
Characteristics at Recommended Test Drive Current , I_f ^{1,2,3}					
Current Density	typ	j	1.5	1.5	A/mm ²
Test Peak Drive Current	typ	I_f	10.5	10.5	A
Peak Luminous Flux ⁴	typ	Φ_v	2100	245	lm
Peak Radiometric Flux	typ	Φ_r	-	10.5	W
Dominant Wavelength ⁶	typ	λ_d	530	447	nm
FWHM- Spectral bandwidth at 50% of Φ_v	typ	$\Delta\lambda_{1/2}$	32	19	nm
Chromaticity Coordinates ^{5,6}	typ	x	0.182	0.160	
	typ	y	0.732	0.017	
Forward Voltage	min	V_{Fmin}	3.9	2.8	V
	typ	V_F	4.5	3.2	V
	max	V_{Fmax}	5.3	4.2	V
Device Thermal Characteristics ⁹					
Thermal Resistance of junction to coreboard ⁸	typ	$R_{\theta j-b}$	0.64	0.64	°C / W
Thermal Resistance of junction to case ⁸	typ	$R_{\theta j-c}$	2.02	2.02	°C / W
Thermal Resistance of junction to heat sink ⁸	typ	$R_{\theta j-hs}$	2.15	2.15	°C / W
Thermal Coefficient of Photometric Flux	typ		-0.2	-0.2	% / °C
Thermal Coefficient of Radiometric Flux	typ		-0.2	-0.2	% / °C
Thermal Coefficient of Junction Voltage	typ		-4.6	-3.5	mV / °C

For notes see page 6.

Absolute Maximum Ratings

	Symbol	Green	Blue	Unit
Absolute Minimum Current		0.2	0.2	A
Absolute Maximum Current		14	14	A
Absolute Maximum Junction Temperature ¹¹	T_{jmax}	150	150	°C
Storage Temperature Range		-40/+100	-40/+100	°C

Note 1: Listed drive conditions are typical for common applications. SBT-70 G,B devices can be driven at currents ranging from 1 A to 10.5 A and at duty cycles ranging from 1% to 100%. Drive current and duty cycle should be adjusted as necessary to maintain the junction temperature desired to meet application lifetime requirements.

Note 2: All ratings are based on a constant case temperature $T_c = 25^\circ\text{C}$.

Note 3: Unless otherwise noted, values listed are typical. Devices are production tested and specified at 10.5 A. Other values are for reference only.

Note 4: Total flux from emitting area at listed dominant wavelength. Reported performance is included to show trends for a selected power level. For specific minimum and maximum values, use bin tables. For product roadmap and future performance of devices, contact Luminus.

Note 5: In CIE 1931 chromaticity diagram coordinates, normalized to $X+Y+Z=1$.

Note 6: For reference only.

Note 7: Caution must be taken not to stare at the light emitted from these LEDs. Under special circumstances, the high intensity could damage the eye.

Note 8: Measurements are in accordance with JEDEC 51-14. For more about thermal resistance calculation, please see <https://luminusdevices.zendesk.com/hc/en-us/articles/4416807960717-Thermal-Heatsink-Required-Rth-Calculator>

Note 9: For more about calculating thermistor temperature, please see <https://luminusdevices.zendesk.com/hc/en-us/articles/4412023747341-How-to-determine-the-temperature-from-Luminus-on-board-Thermistor->

Note 10: Luminus LEDs are designed for operation to an absolute maximum current as specified above. Product lifetime data is specified at recommended forward drive currents. Sustained operation at or beyond absolute maximum currents will result in a reduction of device lifetime compared to recommended forward drive currents. Actual device lifetimes will also depend on junction temperature. Refer to the lifetime derating curves for further information. In pulsed operation, rise time from 10-90% of forward current should be larger than 0.5 microseconds.

Note 11: Lifetime dependent on LED junction temperature. Input power and thermal system must be properly managed to ensure lifetime.

Optical & Electrical Characteristics

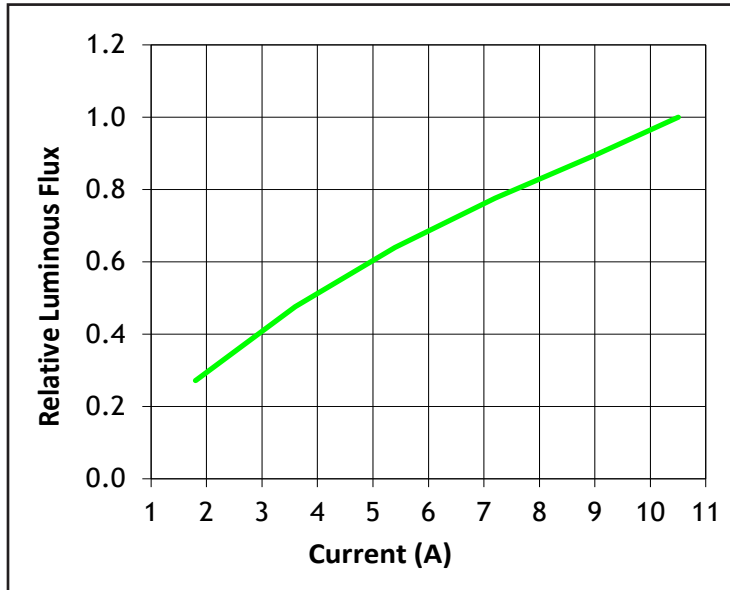
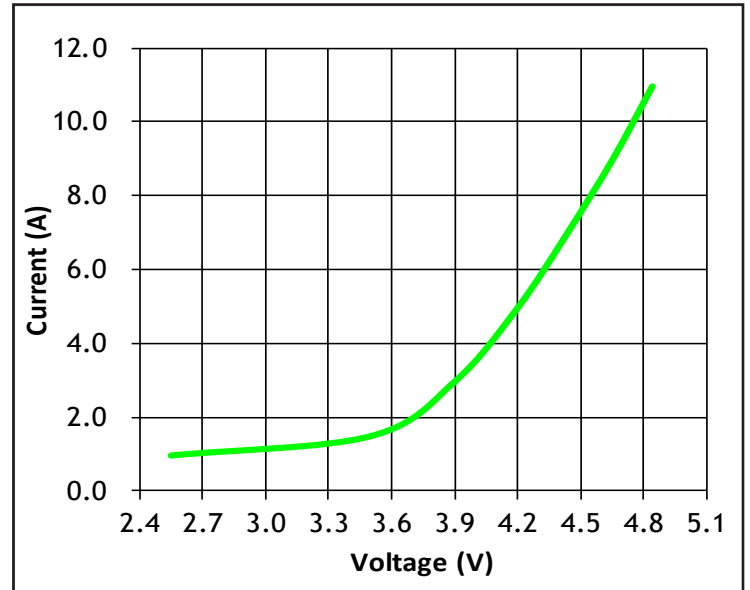
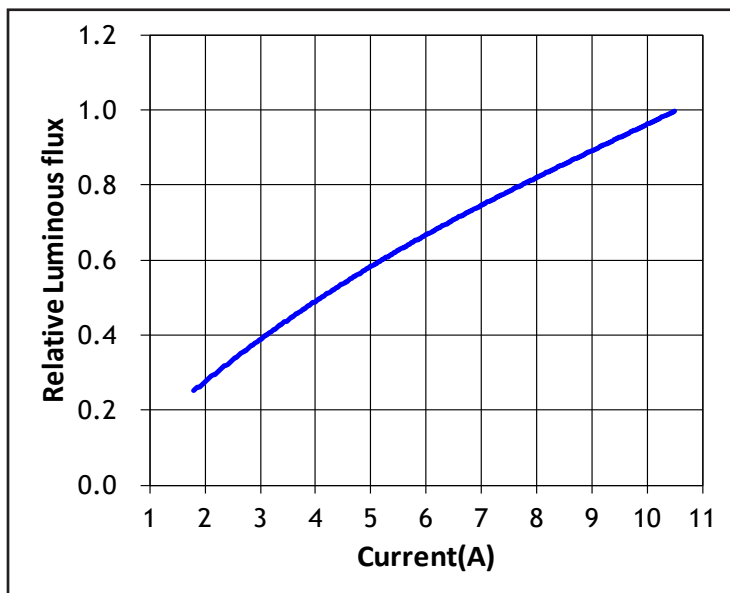
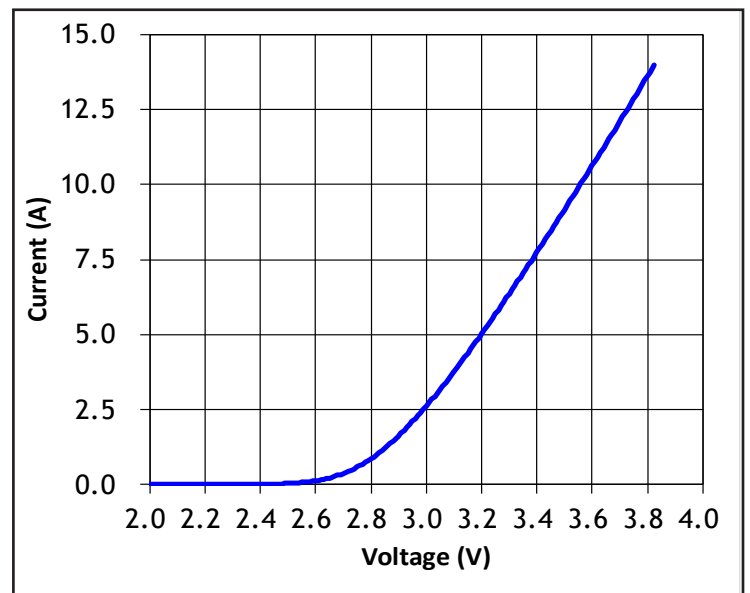
Relative Luminous Flux vs. Forward Current - Green

Forward Current vs. Forward Voltage - Green

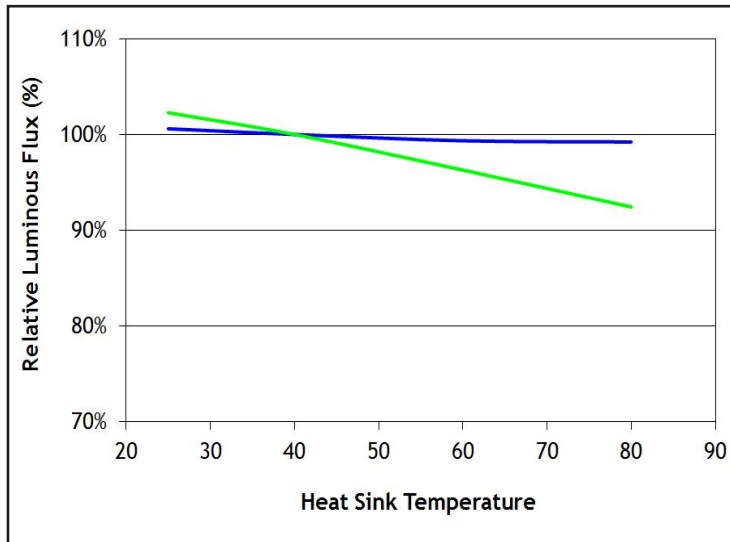
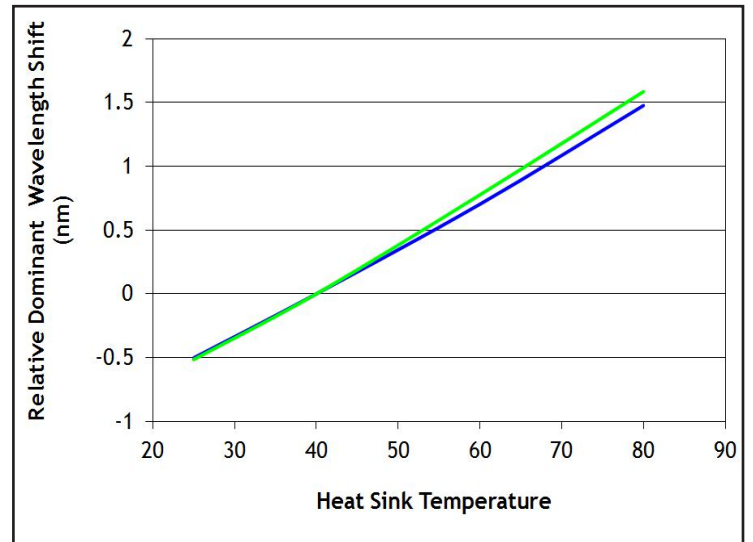
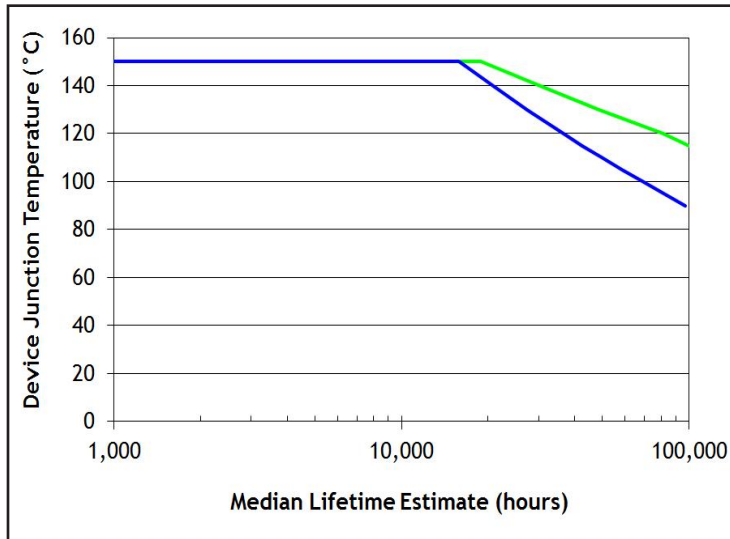
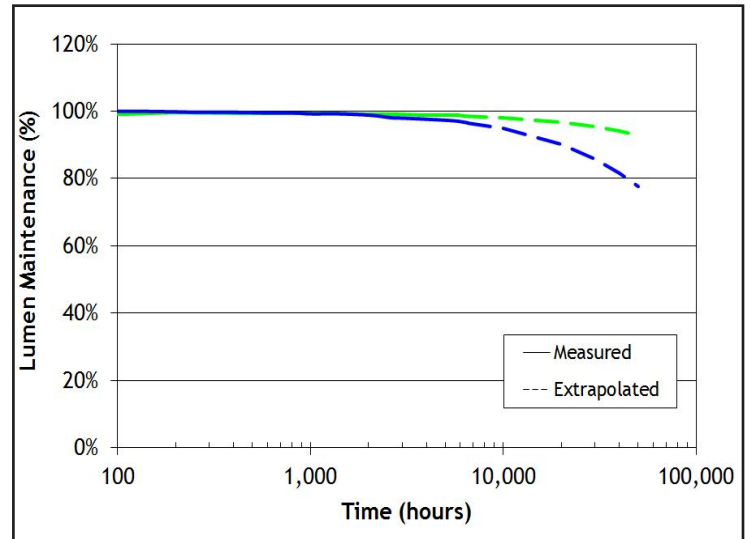
Relative Luminous Flux vs. Forward Current - Blue

Forward Current vs. Forward Voltage - Blue

Optical & Electrical Characteristics

Heat Sink Temperature vs. Relative Luminous Flux

Heat Sink Temperature vs. Relative Dominant Wavelength Shift

Median Lifetime Estimate vs. Junction Temperature ¹

Lumen Maintenance ²

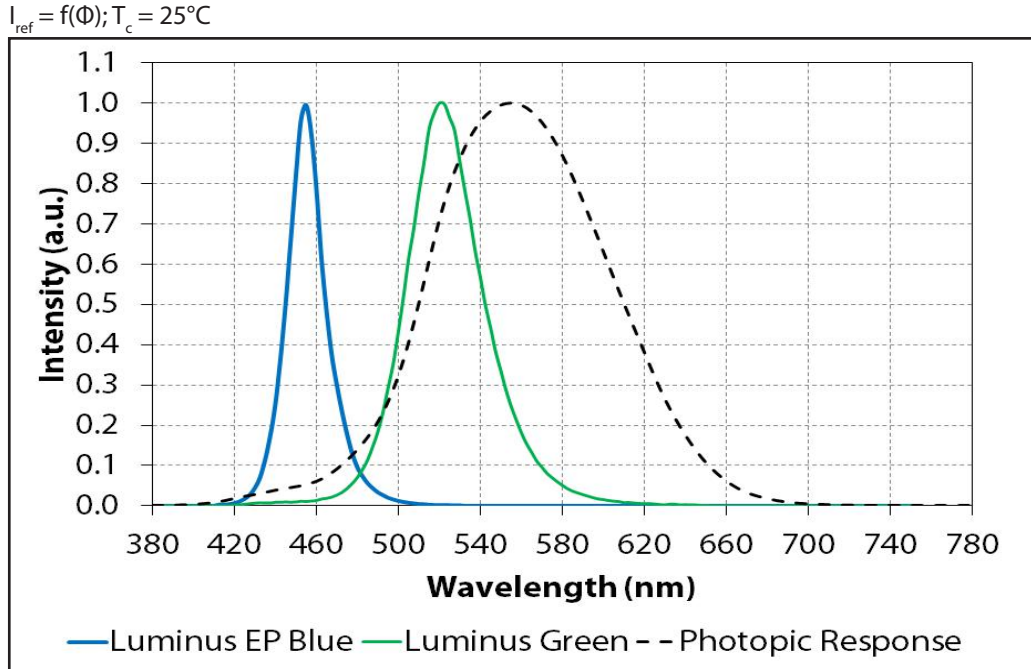
Note 1: Median lifetime estimate as a function of junction temperature at 1.5 A/mm² in continuous operation. Lifetime defined as time to 70% of initial intensity. Based on preliminary lifetime test data. Data can be used to model failure rate over typical product lifetime.

Note 2: Lumen maintenance vs. time at 1.5 A/mm² in continuous operation, case temperature equal to 25°C.

Typical Spectrum



Angular Intensity Distribution (Typical)

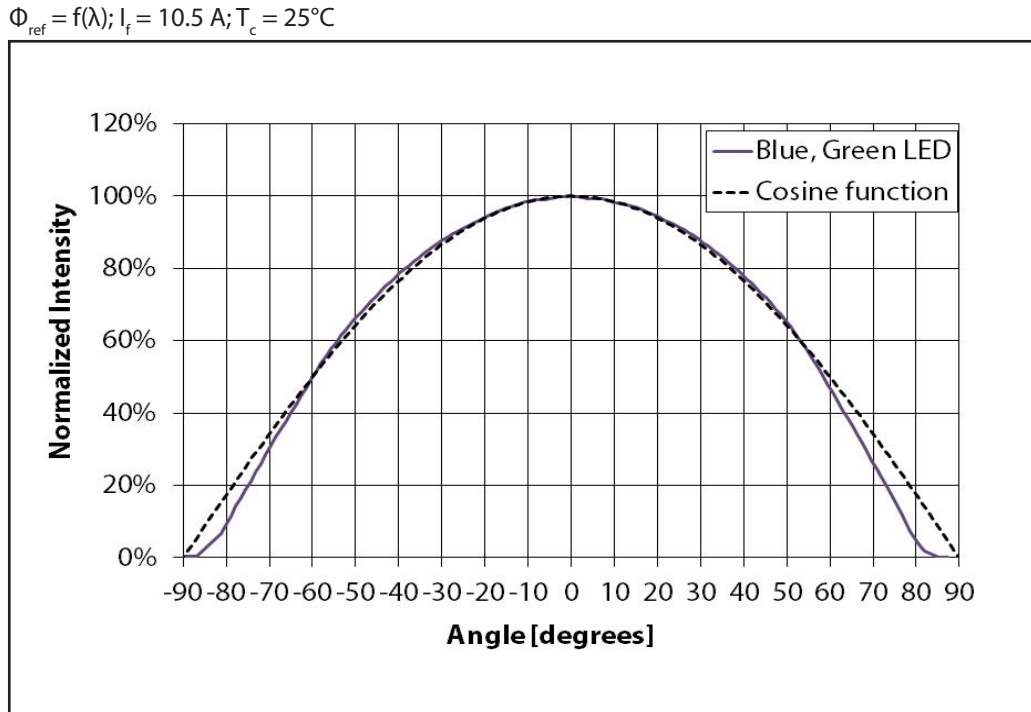

Soldering Profile

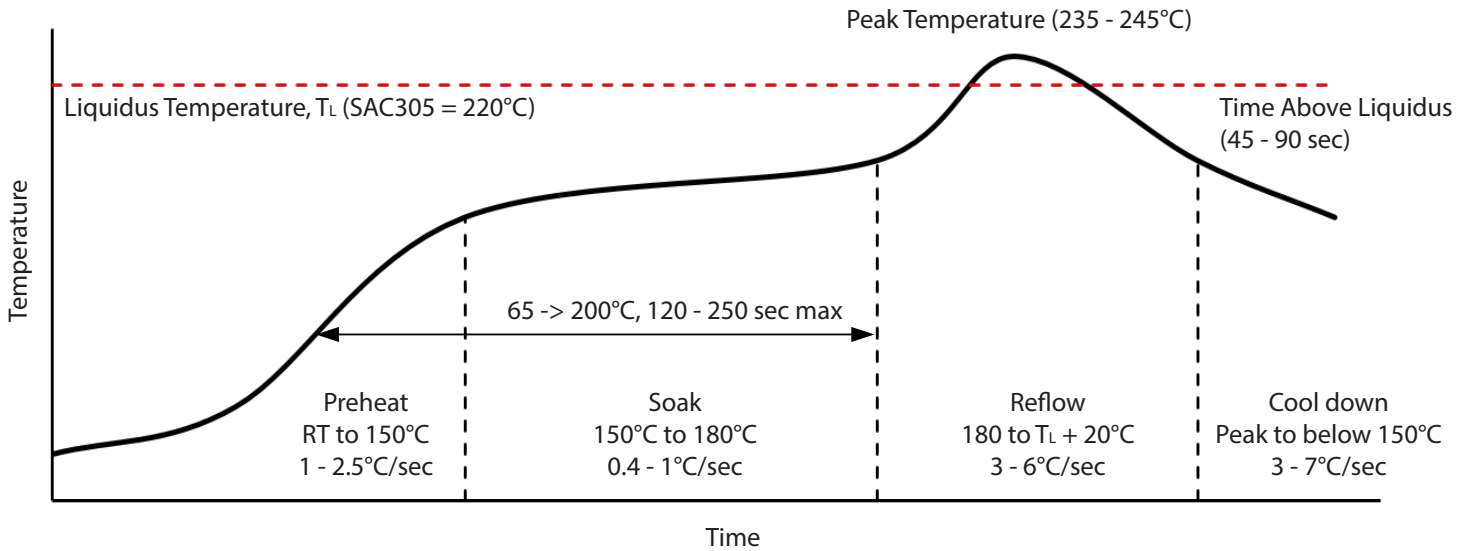

SMT Rework Guideline	Manual Hotplate Reflow	Hot Air Gun Reflow
Heating Time	< 60 sec	
Hotplate Temperature	< 245°C	< 150°C

Note 1: Product complies to Moisture Sensitivity Level 3 (MSL 3)

Note 2: The numbers in the table are specific to SAC305. Luminus recommends using an SAC305 solder paste with a no-clean flux for RoHS compliant products.

Note 3: During the pick and place process, axial forces on the dome (or window) should not exceed 0.5 Newtons (N)

Note 4: Use of a multi-zone IR reflow oven with a nitrogen blanket is recommended.

Note 5: Time-temperature profile of the reflow process showing the four functional profile zones are defined in IPC-7801. Temperature is referenced to the center of the PCB.

Note 6: Luminus recommends to use the solder paste data sheet information as a starting point in time-temperature process development.

Note 7: These are general guidelines. Consult the solder paste manufacturer's datasheet for guidelines specific to the alloy and flux combination used in your application. For more information, please refer to: <https://luminusdevices.zendesk.com/hc/en-us/articles/360060306692-How-do-I-Reflow-Solder-Luminus-SMD-Components->

Note 8: For any technical questions about soldering process, please contact Luminus at techsupport@luminus.com.

Note 9: This part is not compatible with vapor phase reflow processes.

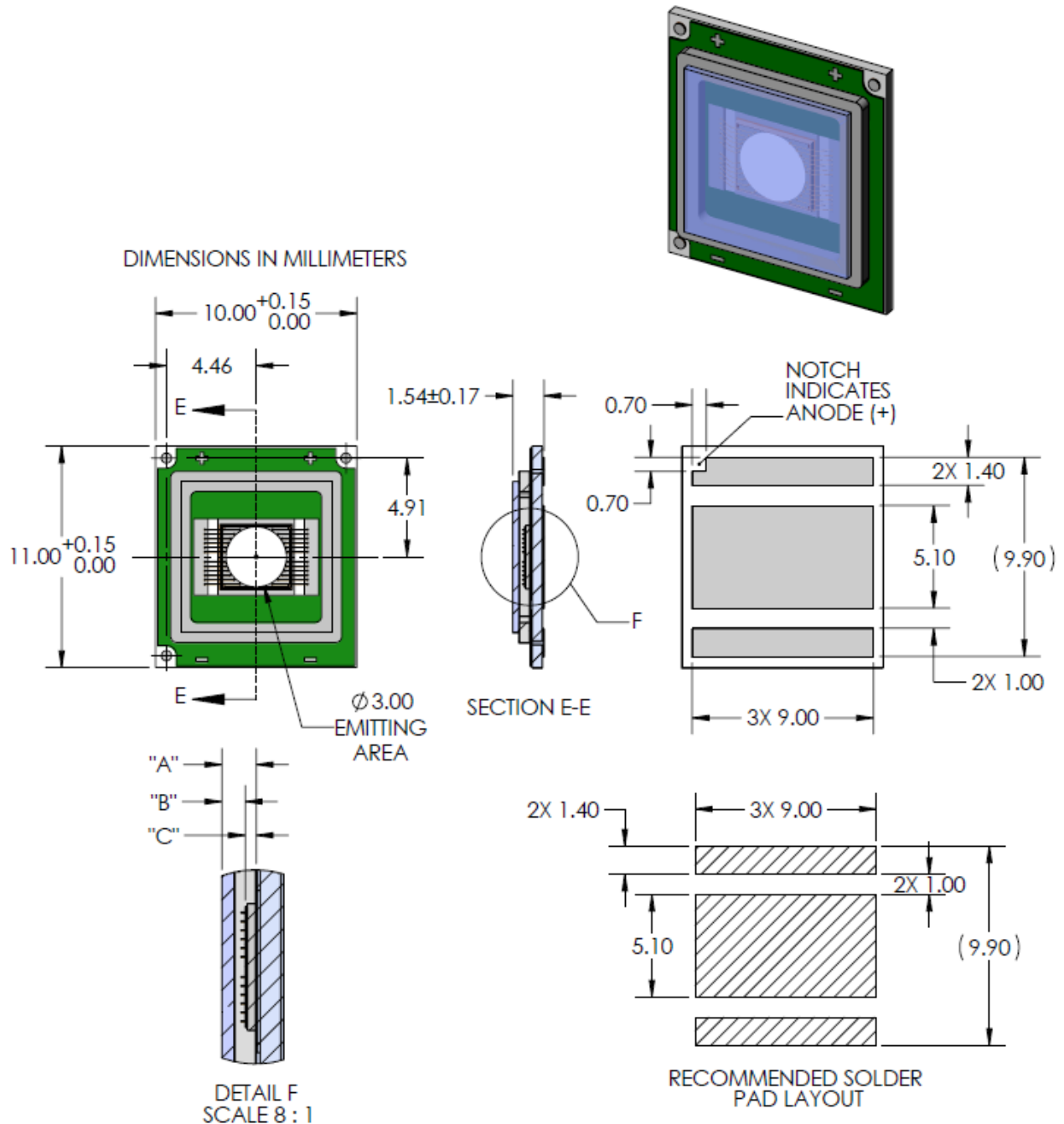
Mechanical Dimensions – SBT-70 Emitter

DIMENSION NAME	DESCRIPTION	NOMINAL DIMENSION	TOLERANCE
"A"	TOP OF CERAMIC SUBSTRATE TO TOP OF GLASS	.86	± 0.10
"B"	TOP OF EMITTING AREA TO TOP OF GLASS	.58	± 0.14
"C"	TOP OF CERAMIC SUBSTRATE TO TOP OF EMITTING AREA	.28	± 0.03

DWG-002087

Mechanical Dimensions – SBT-70 Star Board

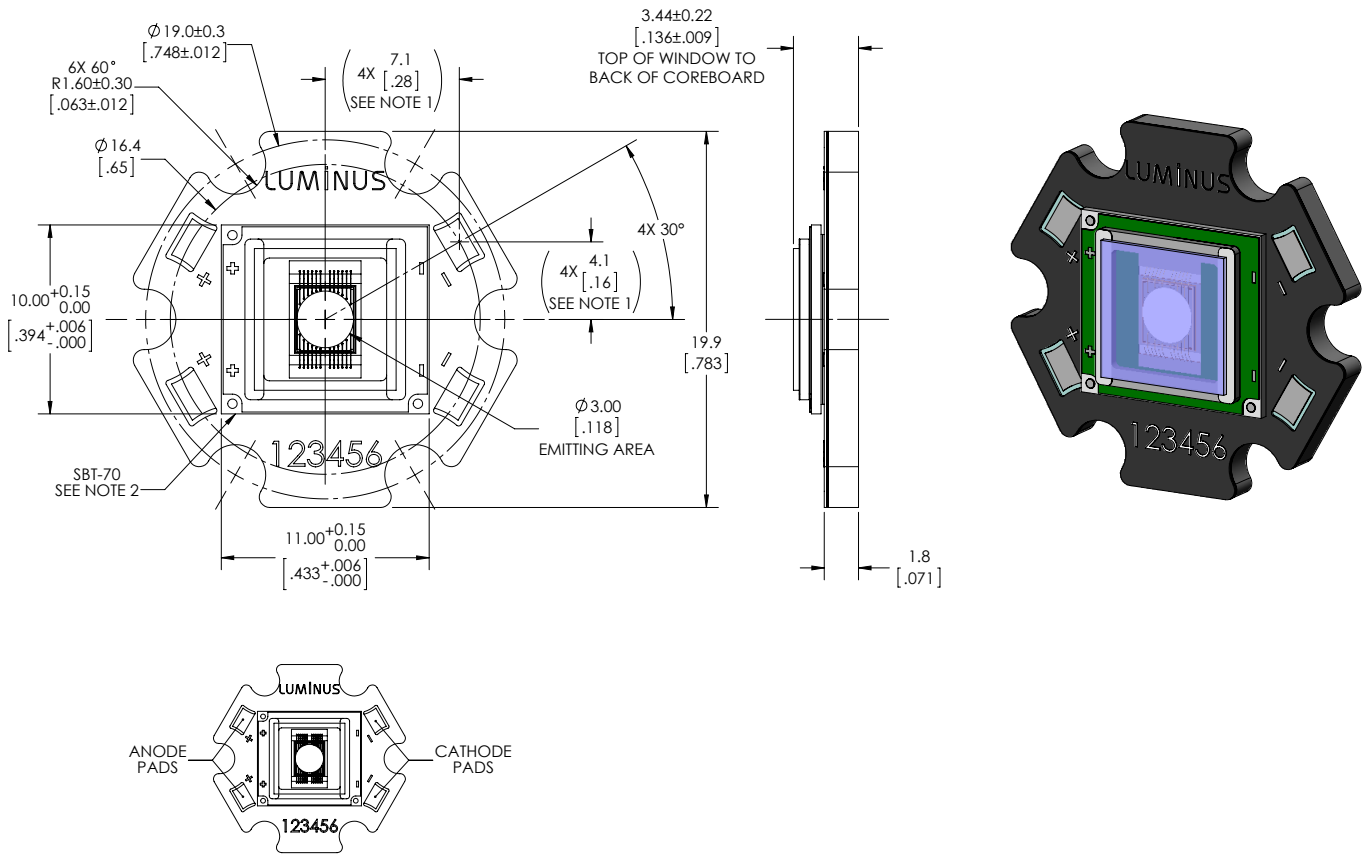

Note 1: Tolerances per IPC-610, Class 2. All dimensions in millimeters

Note 2: For detail drawing of SBT-70, please see page 11.

Note 3: Recommended mounting screw: M3 or #4

Note 4: All anode pads and all cathode pads on board are interconnected.

Shipping Tray Outline

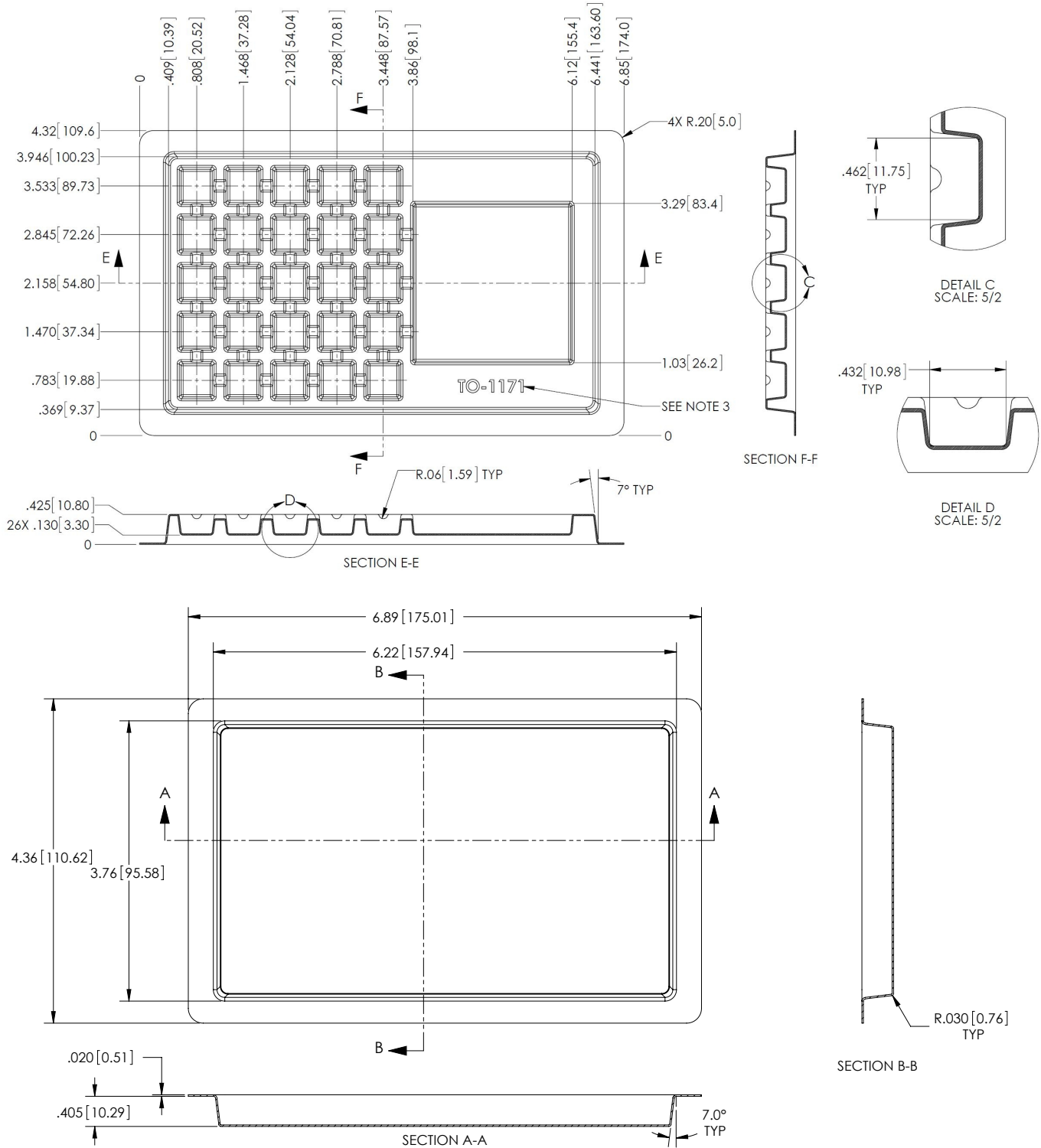

Shipping Label

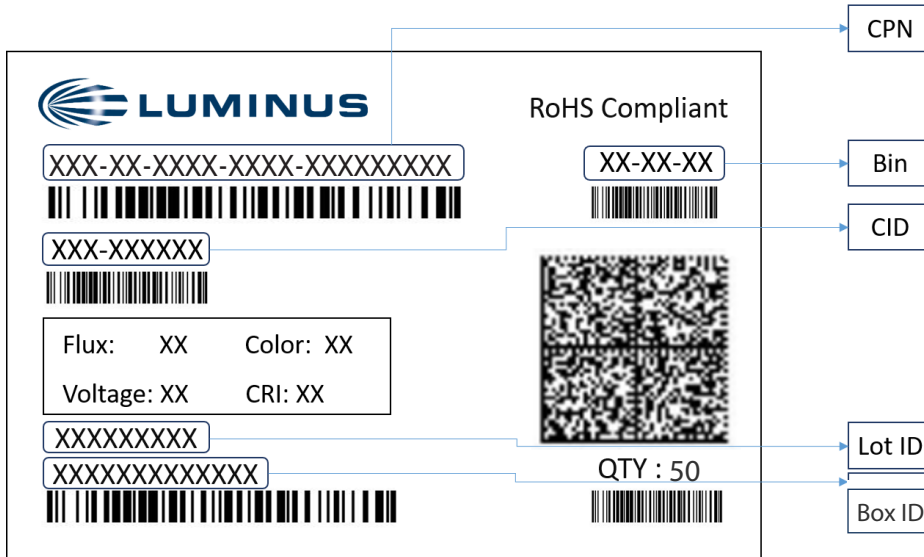

Label Fields:

- CPN: Luminus ordering part number
- CID: Customer's part number
- QTY: Quantity of devices in pack
- Flux: Bin as defined on page 4
- Voltage: NA
- Color: Bin as defined on page 4
- CRI: NA

Packing Configuration:

- Maximum stack of 2 trays per pack with 25 devices per tray
- Partial pack or tray may be shipped
- Each pack is enclosed in anti-static bag
- Shipping label is placed on top of each pack