

SBS[®] X-75A



Dust- Water- Shock

Sealed Connector

- Industrial / Commercial • Power Equipment • Material Handling / Automation
- Agricultural / Construction • Lawn / Garden Equipment • Marine



APP
Anderson Power Products[®]

An IDEAL Company

SBS®X-75A

The SBS®X-75A sealed waterproof connectors come with (2) power contacts rated up to 135A, along with up to (4) auxiliaries rated to 10A offering durability of up to 5,000 mating cycles. Positive metal latches help safeguard against accidental disconnects that may be caused by vibration, while the built-in cable clamp allows for strain relief on wires.

The compact sleek high-power design of these environmentally rugged connectors makes them ideal for outdoor applications. The IP68 weatherproof rating ensures that the connector will be free of water for full protection up to 30 minutes at 6 feet in the mated conditions, or with the use of covers in unmated condition.



600 Volts / 135A
(with Signals)



5,000 Mating Cycles



Operating Temperature
-20°C to 105°C / -4 °F to 221°F



Dust - Water - Shock

SPECIFICATIONS

ELECTRICAL

Current Rating Amperes ¹

Wire to Wire		No Signals		Signals Energized	
AWG	mm ²	UL	CSA	UL	CSA
4 AWG	25	140	85	135	80
6 AWG	16	100	65	95	60
8 AWG	10	95	58	93	53
10 AWG	6	75	45	75	45

Wire Plug to Panel Mount Receptacle

4 AWG (25 mm ²) Wire	145	90	140	85
----------------------------------	-----	----	-----	----

Panel Mount Plug to Panel Mount Receptacle

4 AWG (25 mm ²) Wire	140	85	135	80
----------------------------------	-----	----	-----	----

Voltage Rating AC/DC

UL 1977	600V
---------	------

Dielectric Withstanding Voltage

Volts AC	2,200
----------	-------

Average Mated Contact Resistance Milliohms ¹

Power 1/4 in. of 4 AWG (25 mm ²) Wire	0.16m Ω
Auxiliary 14 AWG (1.0 to 1.5 mm ²) Wire	2.50m Ω

UL Hot Plug Current Rating Amperes

4 AWG (25 mm ²) Wire	250 cycles at 120V DC
	50A

Touch Safe

Per UL 60950-1, UL 62368-1 & IEC 60529³

MECHANICAL

Wire Size Range		
Power Contacts	10 to 4 AWG (2.5 to 25.0 mm ²)	
Auxiliary Contacts	14 to 24 AWG (0.50 to 1.5 mm ²)	
Maximum Wire Insulation Diameter		
Power	0.44 AWG (11.18 mm ²)	
Auxiliary	0.44 AWG (11.18 mm ²)	
Operating Temperature ²	-20° to 105°C (-4 to 221°F)	
Mating Cycles No Load by Plating	5,000	
Average Mating / Unmating Force		
Wire	4 AWG (25 mm ²)	
Lbs / Kg	6.5 Lbs (2.95 Kg)	
Minimum Creepage / Clearance Distance		
	Creepage	Clearance
Power to Power	1.50 in. (38.1 mm)	0.900 in. (22.86 mm)
Power to Signal	1.12 in. (28.4 mm)	0.640 in. (16.26 mm)
Pin to Pin	0.097 in. (2.46 mm)	0.097 in. (2.46 mm)
Socket to Socket	0.352 in. (8.94 mm)	0.352 in. (8.94 mm)
Pin to Socket	1.15 in. (29.21 mm)	0.485 in. (12.3 mm)
Pull Out Force with Cable Clamp	60 lb.	
Retention Force Auxiliary Housing	35 lb.	
Drop Test	Per UL 486A-486B	
IP68	Per UL50E ⁴	

MATERIALS

Housing, Cable Clamps, Covers	PC/PBT
Signal Housing	PC
Latches, Spring, Screws	Stainless Steel
O-Rings, Grommets	Silicone
Panel Mount Gasket	NBR
Housing Flammability Rating	UL94 V0
Glow Wire (1.0 mm)	960°C per 60695-2-12
Wire Power Contact	Silver Plated Copper Alloy
SBS® 75X Auxiliary Contacts	
Pin	Copper Alloy, Au over Ni
Socket	Be Cu, Au over Ni
Socket Body	Copper Alloy, Tin Bright over Ni
Retention Clip	Stainless Steel

NOTES:

- 1 - Current amperage ratings are based on 105°C rated or better cable of the largest wire size using properly calibrated APP® recommended tooling, and a 25°C ambient temperature, or CSA rating below a 30°C temperature rise. UL rating not to exceed the maximum operating temperature. Connector to be assembled and installed according to the manufacturer's instructions.
- 2 - Operating Temperatures are limited by the thermal properties of the connector's plastic housing.
- 3 - Sealed Connector Series offers protection against electric shock for finger safety both in mated and unmated condition. The Sealed SBS®X-75A Connector Series was tested for IP Code 1X-2X per clause 12- & 13 of IEC 60529, Edition 2.2, issued 2013-8 + Corr. 1:2013-10 + Corr. 2:2015-01. The connector was tested for IP1X and IP2 in mated and unmated condition, which is representative of protection against access to energized parts contained in UL 60950-1 2nd Edition, 2011-12-19 and UL 62368-1 3rd Edition, 2021-10-22.
- 4 - The Sealed SBS®X-75A Connector Series was subjected to submersion test, covered by UL 50E Standard for Enclosures for Electrical Equipment Environmental Considerations, 3rd Edition, with a pressure equivalent to 6 feet of water and for a duration of 30 minutes for the equivalent IP68 compliance. Note panel mount-to-panel mount configuration has not been tested for ingress protection rating; contact manufacturer to determine if it will work for your application.

TEMPERATURE CHARTS

SBS®X-75A Primary Contacts Only
Temperature Rise at Constant Current

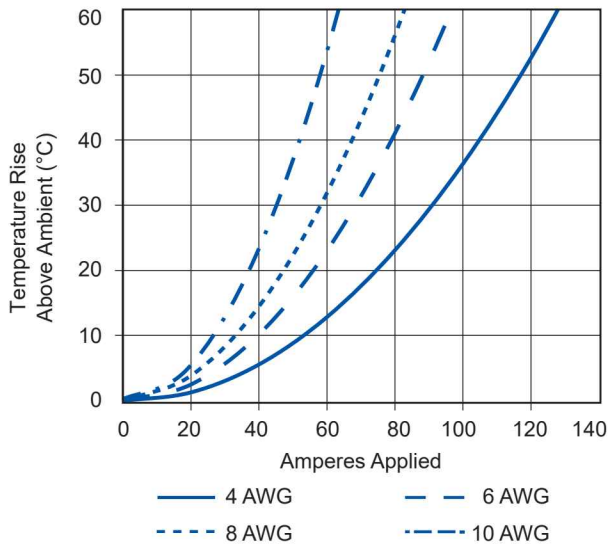

SBS®X-75A Primary Contacts Only
Derating vs. Ambient Temperature

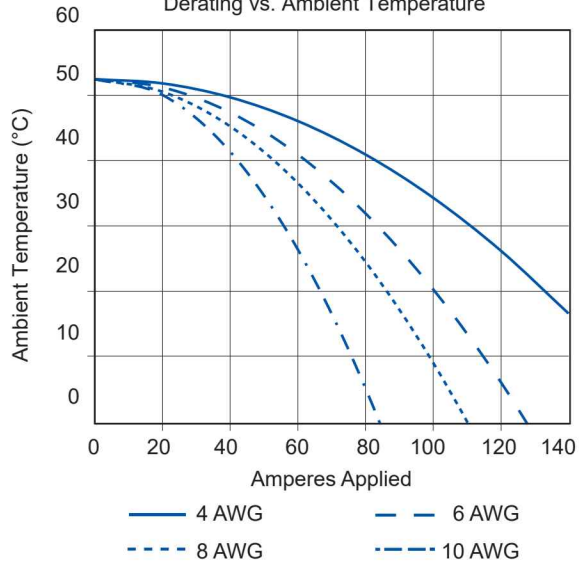

SBS®X-75A Auxiliary Contacts at 10A
Temperature Rise at Constant Current

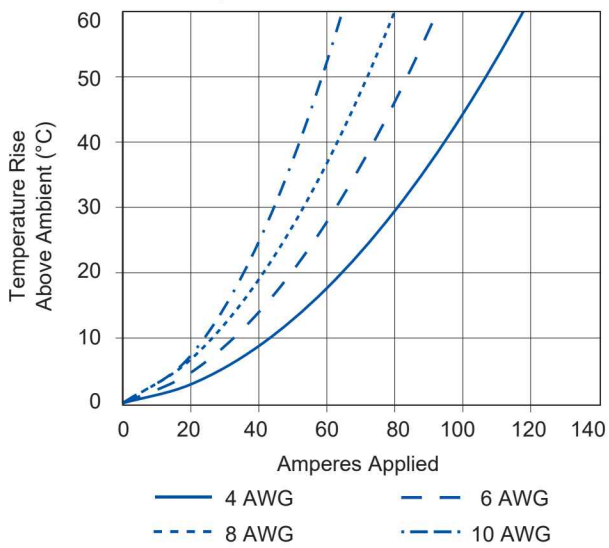

SBS®X-75A Auxiliary Contacts at 10A
Derating vs. Ambient Temperature

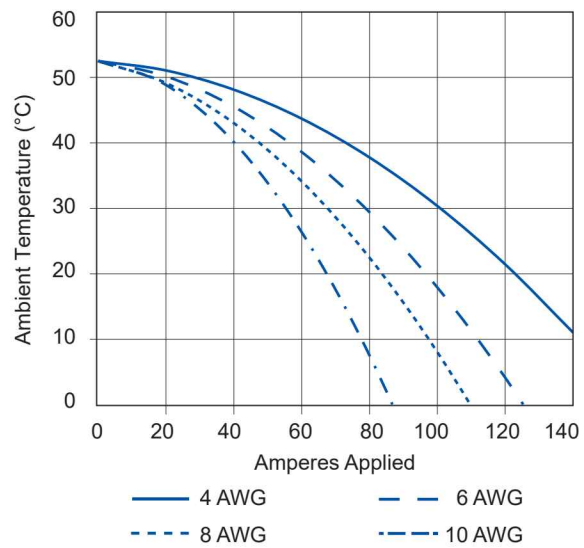

COMPONENTS

Wire-to-Wire

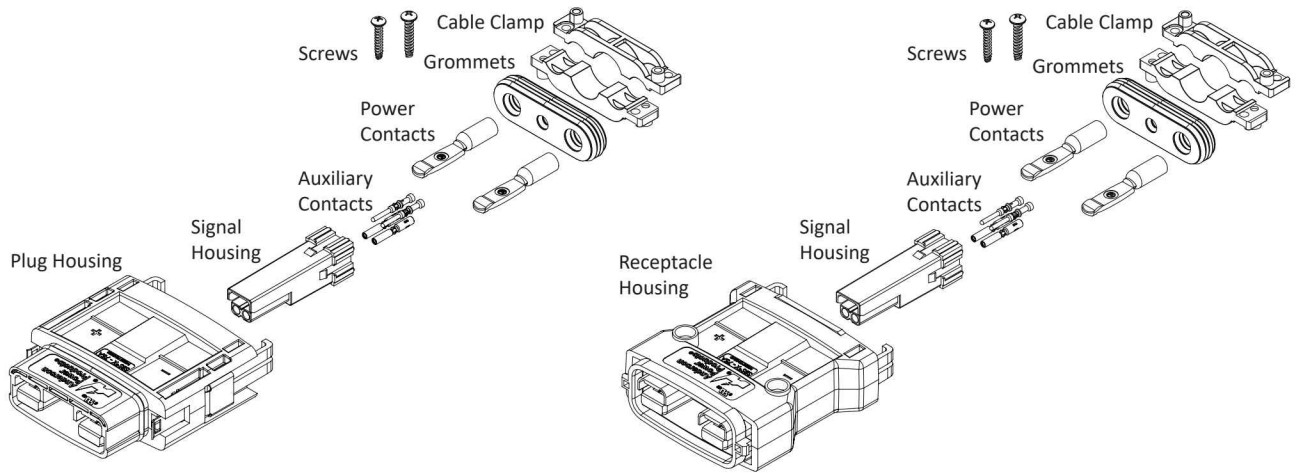

Wire-to-Panel Mount

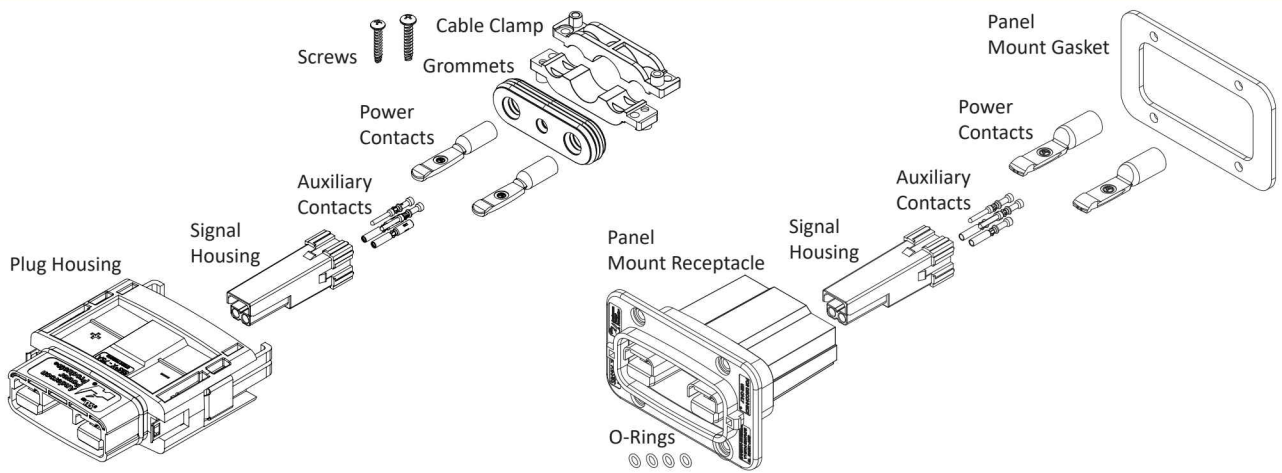



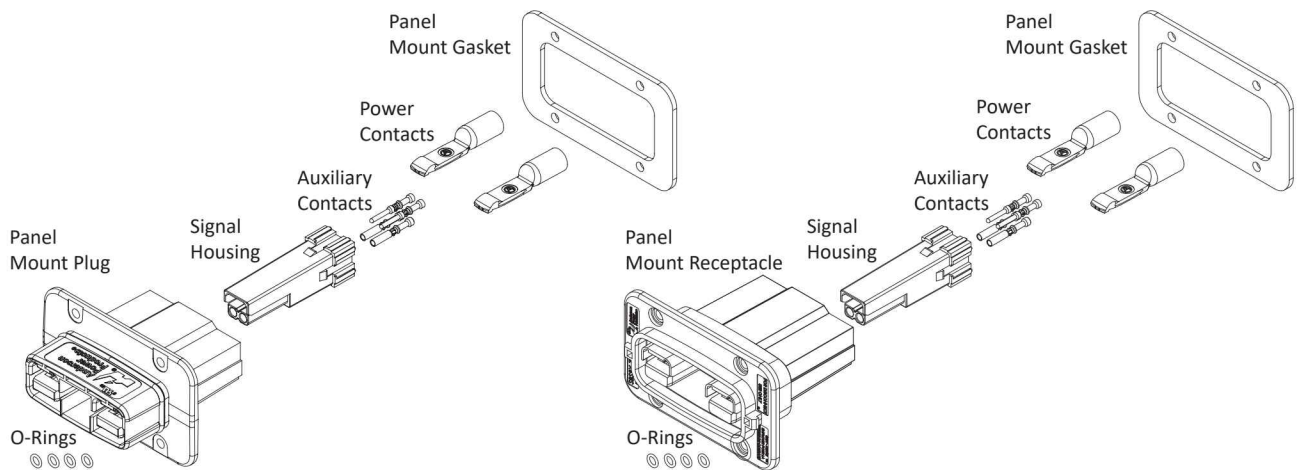

Panel Mount-to-Panel Mount







ORDERING INFORMATION - Color denotes signal housing only. All other housings are black.

Step 1: Select the Housing Kit - Packaged as Individual Kits. Contacts and Grommets Sold Separately, See Step 2 & 3

Image	Part Number	Description- Sealed SBS®X-75A	Kit Includes- Housing, Signal Housing and Below Parts
	Minimum Quantity		1
	SBSX75A-PLUG-KIT-RED	Male Plug - Red	Latches, Cable Clamp, Hardware & Front O-Rings
	SBSX75A-PLUG-KIT-BLU	Male Plug - Blue	Latches, Cable Clamp, Hardware & Front O-Rings
	SBSX75A-PLUG-KIT-GRA	Male Plug - Gray	Latches, Cable Clamp, Hardware & Front O-Rings
	SBSX75A-PLUG-KIT-BLK	Male Plug - Black	Latches, Cable Clamp, Hardware & Front O-Rings
	SBSX75A-REC-KIT-RED	Female Receptacle - Red	Cable Clamp, Hardware
	SBSX75A-REC-KIT-BLU	Female Receptacle - Blue	Cable Clamp, Hardware
	SBSX75A-REC-KIT-GRA	Female Receptacle - Gray	Cable Clamp, Hardware
	SBSX75A-REC-KIT-BLK	Female Receptacle - Black	Cable Clamp, Hardware
	SBSX75A-PMREC-KIT-RED	Panel Mount Receptacle - Red *	Panel Gasket, Mounting O-Rings
	SBSX75A-PMREC-KIT-BLU	Panel Mount Receptacle - Blue *	Panel Gasket, Mounting O-Rings
	SBSX75A-PMREC-KIT-GRA	Panel Mount Receptacle - Gray *	Panel Gasket, Mounting O-Rings
	SBSX75A-PMREC-KIT-BLK	Panel Mount Receptacle - Black *	Panel Gasket, Mounting O-Rings
	SBSX75A-PMPLUG-KIT-RED	Panel Mount Plug - Red *	Front O-Ring, Panel Gasket, Mounting O-Rings
	SBSX75A-PMPLUG-KIT-BLU	Panel Mount Plug - Blue *	Front O-Ring, Panel Gasket, Mounting O-Rings
	SBSX75A-PMPLUG-KIT-GRA	Panel Mount Plug - Gray *	Front O-Ring, Panel Gasket, Mounting O-Rings
	SBSX75A-PMPLUG-KIT-BLK	Panel Mount Plug - Black *	Front O-Ring, Panel Gasket, Mounting O-Rings

Bulk Component Ordering Information - All components sold separately. For grommets and contacts, see step 2 & 3.



Image	Part Number	Description- Sealed SBS®X-75A	Includes
	Minimum Quantity		100
	SBSX75A-PLUG-BLK	Male Plug Housing	Housing, Latches & O-Rings
	SBSX75A-REC-BLK	Female Receptacle Housing	Housing
	SBSX75A-PMREC-BLK	Panel Mount Receptacle Housing	Housing
	SBSX75A-PMPLUG-BLK	Panel Mount Plug Housing *	Housing, Front O-Ring

* Panel Mount Plug mates with Panel Mount Receptacle for Panel-to-Panel applications. Please note that this configuration has not been tested for Ingress protection ratings, please contact the manufacturer for further details on this requirement to see if it will work for your application needs. Panel Mount hardware not included.

Step 1 Continued - Bulk Components Continued

	Minimum Quantity		200
	2-8840P1	Signal Housing - Red	Housing
	2-8840P2	Signal Housing - Blue	Housing
	2-8840P3	Signal Housing - Gray	Housing
	2-8840P4	Signal Housing - Black	Housing
	2-8841P1	Cable Clamp	Cable Clamp (set of two)
	H1120P62	#4 to 20 5/8" (15.88mm) Plastite Head Screws - Cable Clamp	Screws
	108G1	Panel Mount Hardware Kit	Panel Mount Gasket, Mounting O-Rings

Covers - Use When Parts are Unmated for IP68 Protection

Image	Part Number	Description- Sealed SBS®X-75A	Includes
	Minimum Quantity		1
	SBSX75A-PLUG-COVER	Plug Cover *	Housing, Lanyard
	SBSX75A-REC-COVER	Receptacle Cover	Housing, Latches, O-Ring, Lanyard
	SBSX75A-PMREC-COVER	Panel Mount Receptacle Cover	Housing, Latches, O-Ring, Lanyard

* Inquire with Manufacturer or Sales Representative regarding panel mount plug covers

Step 2: Grommets Sold Separately

To select proper grommet size, you will need to know the outer diameter of jacketed cable for each of the Power and Signal cables. Find your overall power size, then determine appropriate outer dimension for both Power and Signal cables. Not using signal, then select NS grommet that matches your power only size. Panel mount housings do not require grommets.

Discrete Wires



Discrete Wire
Power & Signal

Part Number	Wire Size AWG	Wire Size mm ²	Power Wire Diameter Range (mm ²)	Signal Cable / Wire Size Diameter Range (mm ²)
D-150-060	10 to 12	2.5 to 6	0.15 to 0.18 (3.81 to 4.57)	0.08 to 0.10 (2.03 to 2.54)
D-310-060	6 to 4	16	0.31 to 0.34 (7.87 to 8.64)	0.08 to 0.10 (2.03 to 2.54)

Jacket Cable



Jacket Cable
Power & Signal



Power Only

Part Number	Wire Size AWG	Wire Size mm ²	Power Wire Diameter Range (mm ²)	Signal Cable / Wire Size Diameter Range (mm ²)
Minimum Quantity 1				
J-150-150	10 to 12	2.5 to 6	0.15 to 0.18 (3.81 to 4.57)	0.15 to 0.18 (3.81 to 4.57)
J-150-180	10 to 12	2.5 to 6	0.15 to 0.18 (3.81 to 4.57)	0.18 to 0.21 (4.57 to 5.33)
J-150-320	10 to 12	2.5 to 6	0.15 to 0.18 (3.81 to 4.57)	0.32 to 0.35 (8.13 to 8.89)
J-150-350	10 to 12	2.5 to 6	0.15 to 0.18 (3.81 to 4.57)	0.35 to 0.38 (8.89 to 9.65)
J-150-380	10 to 12	2.5 to 6	0.15 to 0.18 (3.81 to 4.57)	0.38 to 0.41 (9.65 to 10.41)
J-150-410	10 to 12	2.5 to 6	0.15 to 0.18 (3.81 to 4.57)	0.41 to 0.44 (10.41 to 11.18)
NS-150	10 to 12	2.5 to 6	0.15 to 0.18 (3.81 to 4.57)	Power Cable
J-240-150	8	10	0.24 to 0.27 (6.10 to 6.86)	0.15 to 0.18 (3.81 to 4.57)
J-240-180	8	10	0.24 to 0.27 (6.10 to 6.86)	0.18 to 0.21 (4.57 to 5.33)
J-240-320	8	10	0.24 to 0.27 (6.10 to 6.86)	0.32 to 0.35 (8.13 to 8.89)
J-240-350	8	10	0.24 to 0.27 (6.10 to 6.86)	0.35 to 0.38 (8.89 to 9.65)
J-240-380	8	10	0.24 to 0.27 (6.10 to 6.86)	0.38 to 0.41 (9.65 to 10.41)
J-240-410	8	10	0.24 to 0.27 (6.10 to 6.86)	0.41 to 0.44 (10.41 to 11.18)
NS-240	8	10	0.24 to 0.27 (6.10 to 6.86)	No Signal
J-310-150	6	16	0.31 to 0.34 (7.87 to 8.64)	0.15 to 0.18 (3.81 to 4.57)
J-310-180	6	16	0.31 to 0.34 (7.87 to 8.64)	0.18 to 0.21 (4.57 to 5.33)
J-310-320	6	16	0.31 to 0.34 (7.87 to 8.64)	0.32 to 0.35 (8.13 to 8.89)
J-310-350	6	16	0.31 to 0.34 (7.87 to 8.64)	0.35 to 0.38 (8.89 to 9.65)
J-310-380	6	16	0.31 to 0.34 (7.87 to 8.64)	0.38 to 0.41 (9.65 to 10.41)
J-310-410	6	16	0.31 to 0.34 (7.87 to 8.64)	0.41 to 0.44 (10.41 to 11.18)
NS-310	6	16	0.31 to 0.34 (7.87 to 8.64)	No Signal
J-410-150	4	25	0.41 to 0.44 (10.41 to 11.18)	0.15 to 0.18 (3.81 to 4.57)
J-410-180	4	25	0.41 to 0.44 (10.41 to 11.18)	0.18 to 0.21 (4.57 to 5.33)
J-410-320	4	25	0.41 to 0.44 (10.41 to 11.18)	0.32 to 0.35 (8.13 to 8.89)
J-410-350	4	25	0.41 to 0.44 (10.41 to 11.18)	0.35 to 0.38 (8.89 to 9.65)
J-410-380	4	25	0.41 to 0.44 (10.41 to 11.18)	0.38 to 0.41 (9.65 to 10.41)
J-410-410	4	25	0.41 to 0.44 (10.41 to 11.18)	0.41 to 0.44 (10.41 to 11.18)
NS-410	4	25	0.41 to 0.44 (10.41 to 11.18)	No Signal

NOTE: Don't see your cable size requirements? Speak to Manufacturer or your local Representative about other options regarding custom grommets.

Step 3: Contacts Sold Separately for Power and Signal

Silver Plated Primary Power Wire Contacts

SBS®X-75A housings use two silver plated contacts per housing for the best electrical performance and durability up to 10,000 mating cycles.

Description	AWG	mm ²	Part Numbers- Loose Piece		Diameter - A-	
					inches	mm
Minimum Quantity			1,000	100		
Standard	4	25	1339G4-BK	1339G4 *	0.28	7.11
	6	16	1339G2-BK	1339G2 *	0.22	5.60
	8	10	1339G5-BK	1339G5 *	0.19	4.70
	12 to 10	2.5 to 6	1339G3-BK	1339G3 *	0.14	3.50

* Are sold as pairs. 2 contacts ship for every 1 ordered.

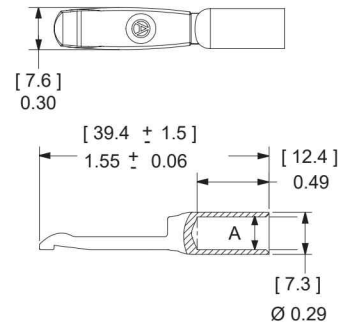

Pin Contacts for Auxiliary (4)

Gold plated contacts are available in 3 lengths to allow sequencing of circuits.

Description	AWG	mm ²	Part Numbers
Minimum Quantity			500
Standard Length 7.7 mm	16 to 14	1.0 to 1.5	PM16P1416S30
	20 to 16	0.75 to 1.0	PM16P1620S30
	24 to 20	0.50 to 0.75	PM16P2024S30
Pre-Mate 9.3 mm	16 to 14	1.0 to 1.5	PM16P1416A30
	20 to 16	0.75 to 1.0	PM16P1620A30
	24 to 20	0.50 to 0.75	PM16P2024A30
Post-Mate 6.4 mm	16 to 14	1.0 to 1.5	PM16P1416C30
	20 to 16	0.75 to 1.0	PM16P1620C30
	24 to 20	0.50 to 0.75	PM16P2024C30

Auxiliary Pin Contact Lengths

	- L -		- L1 -	
	in.	mm	in.	mm
Standard Length 7.7 mm	0.77	19.6	0.30	7.7
Pre-Mate 9.3 mm	0.83	21.2	0.37	9.3
Post-Mate 6.4 mm	0.72	18.3	0.25	6.4

See drawings on website for further details.

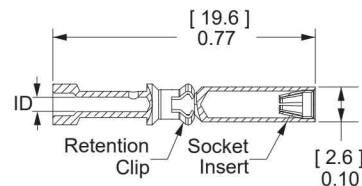

Socket Contacts for SBS®X-75A Auxiliary

Selective gold plated contacts offer low resistance and durability up to 10,000 mating cycles.

Description	AWG	mm ²	Part Numbers
Minimum Quantity			500
Socket Contacts	16 to 14	1.0 to 1.5	PM16S1416S32
	20 to 16	0.75 to 1.0	PM16S1620S32
	24 to 20	0.50 to 0.75	PM16S2024S32

Auxiliary Socket Contacts Crimp Barrel ID

AWG	in.	mm.
16 to 14	0.08	2.1
20 to 16	0.07	1.7
24 to 20	0.04	1.1

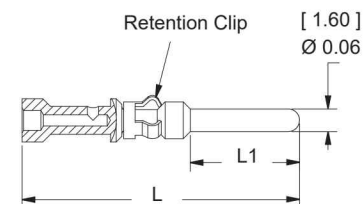

See drawings on website for further details.

SBS® TOOLING INFORMATION ⁵

Wire Size		Power / Ground Contacts								
AWG	mm ²	Power Contact Part Number	Pneumatic Bench Tool	+	Die	+	Locator	Number of Crimps	OR	Hand Tool
4	25.0	1339G4	1387G1		1388G7		1389G9	Single		N/A
6	13.3	1339G2	1387G1		1388G6		1389G9	Single		1309G4
8	8.4	1339G5		1388G7						
10 to 12	5.3 to 3.3	1339G3								

Wire Size		Auxiliary Contacts								
AWG	mm ²	Auxiliary Contact Part Number	APP® Hand Tool w/ Integral Locator	OR	Mil Std. Hand Tool ⁶ M22520/1-01	OR	Pneumatic Tool ⁶	Number of Crimps	+	Locator for: TM0001 & TP0001
12 to 24	2.5 to 0.25	All Crimp Pins All Crimp Sockets	PM1000G1		TM0001		TP0001	Single		TL0001 TL0002

Auxiliary Contact Insertion Tool: 111038G3

Auxiliary Contact Extraction Tool: PM1003G1

Auxiliary Contact Insertion Inspection Tool: PM1003GX

Single Housing Extraction Tool: 116081P1

Tools



NOTES:

- 5 - The use of APP® recommended tooling is strongly recommended. The use of alternate tools may adversely affect the performance of our connectors along with UL and CSA recognition.
- 6 - TP001 and TM0001 tools require locators TL001 for Pins and TL002 for Sockets. The Auxiliary contacts used with wire sizes 16 to 24 AWG (1.5 to 0.50) cannot be properly inserted without the insertion tool. Properly installed Auxiliary contacts of all wire gauges cannot be removed from the housing without the extraction tool. It is highly recommended that inspection tool be used to ensure the auxiliary contacts are seated properly in the housing.
- 7 - The Signal Housing Extraction Tool must be used in order to remove the signal housing from the main housing should position be inserted incorrectly for mating. See assembly instructions for further information.

BUILD YOUR PART NUMBER

Step 1

Housings (including signals)

Cable Clamp

Screw

Panel Mount Kit

Covers

Step 2

Grommets

Step 3

Power Contacts

Signal Contacts

Tooling
