

POWER MANAGEMENT

Features

- Input voltage range — 1.7V to 5.5V
- 3A continuous output current
- Ultra-Low R_{dson} — $9m\Omega$
- Constant R_{dson} over wide V_{IN} range
- Device Options
 - SC33001A — Slow turn on slew and with automatic output discharge
 - SC33001AH — Slow turn on slew with no output discharge circuit
- Typical current limit 6A
- Minimum current limit 3A
- Typical foldback current limit 2A
- Over temperature protection
- Low shutdown current
- Low quiescent current
- Package: CSP — 0.9mm x 1.4mm , 0.5mm Pitch

Applications

- Battery powered equipment
- Smart Phones/Tablet PCs
- Consumer electronics
- STB/Audio/Video
- Industrial/Network equipment
- Other Portable Devices

Description

The SC33001A/AH are a family of an ultra-low R_{dson} load switch optimized for use in battery powered applications. This family of devices support up to 3A continuous output current. Sophisticated integrated circuitry maximizes V_{gs} of the power NMOS to minimize R_{dson} resistance over a wide range of operating conditions.

The device provides a controlled soft-start to limit inrush current. SC33001A features an automatic discharge circuit which discharges the output when the SC33001A is disabled. SC33001AH does not include the automatic output discharge circuitry.

SC33001A/AH family has integrated current limit and over temperature to prevent the device from failure when down stream circuitry is at low impedance fault conditions.

The SC33001A/AH are offered in an ultra small 6-bump 0.9mm x 1.4mm Chip Scale Package (CSP) which enables very small board area implementations. The SC33001A/SC33001AH has an operating temperature range of -40°C to $+85^{\circ}\text{C}$.

Typical Application Circuit

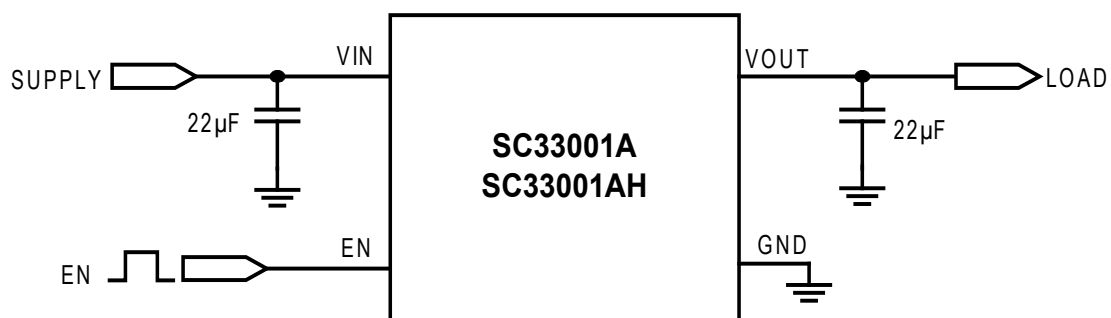

Pin Configuration

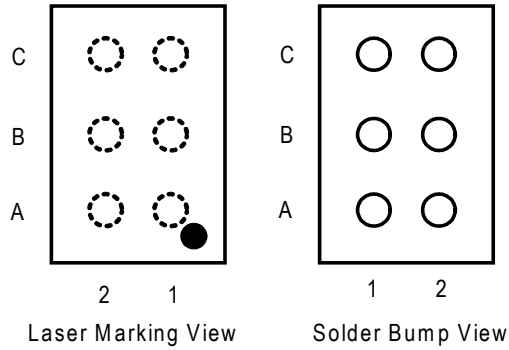

Ordering Information

Device	Package
SC33001ACSTRT ⁽¹⁾⁽²⁾	CSP 0.9mm × 1.4mm, 6-Bump
SC33001AHCSTRT ⁽¹⁾⁽²⁾	CSP 0.9mm × 1.4mm, 6-Bump
SC33001A-EVB	Evaluation Board
SC33001AH-EVB	Evaluation Board

Notes:

- (1) Available in tape and reel only. A reel contains 3,000 devices.
- (2) Lead-free package only. Device is WEEE and RoHS compliant.

Terminals Assignments

	1	2
C	GND	EN
B	VOUT	VIN
A	VOUT	VIN

Marking Information

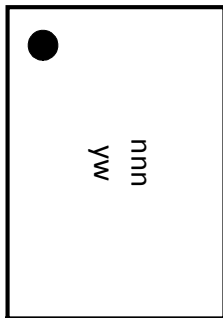

- nnn = Part No. Code — SC33001A: KS1
- nnn = Part No. Code — SC33001AH: KSH
- yw = Datecode

Absolute Maximum Ratings

V _{IN} (V)	-0.3 to +6.0
EN (V)	-0.3 to +6.0
V _{OUT} (V)	-0.3 to (V _{IN} + 0.3)
ESD HBM Protection Level ⁽¹⁾	Class 1C

Recommended Operating Conditions

Ambient Temperature Range (°C)	-40 ≤ T _A ≤ +85
V _{IN} (V)	1.7 to 5.5
V _{VOUT} (V)	0 to V _{IN}
Maximum Output Current (A)	3

Thermal Information

Thermal Resistance, Junction to Ambient ⁽²⁾ (°C/W) ...	125
Maximum Junction Temperature (°C)	+150
Storage Temperature Range (°C)	-65 to +150
Peak IR Reflow Temperature (10s to 30s) (°C)	+260

Exceeding the above specifications may result in permanent damage to the device or device malfunction. Operation outside of the parameters specified in the Electrical Characteristics section is not recommended.

NOTES:

- (1) Tested according to JEDEC standard JESD22-A114-B.
- (2) Calculated from package in still air, mounted to 3 x 4.5 (in), 4 layer FR4 PCB with thermal vias under the exposed pad per JESD51 standards.

Electrical Characteristics

Unless otherwise noted V_{IN} = 5.5V, C_{IN} = 2.2µF, C_{OUT} = 22µF, V_{EN} ≥ V_{IH}, T_A = -40°C to +85°C. Typical values are at T_A = 25°C.

Parameter	Symbol	Conditions	Min	Typ	Max	Units
ON-state Resistance	R _{DSON}	I _{OUT} = 500mA, V _{IN} = 1.7V		9		mΩ
		I _{OUT} = 500mA, V _{IN} = 2.5V		9		
		I _{OUT} = 500mA, V _{IN} = 3.3V		9		
		I _{OUT} = 500mA, V _{IN} = 3.6V		9		
		I _{OUT} = 500mA, V _{IN} = 5.5V		9		
		I _{OUT} = 500mA, 1.7V ≤ V _{IN} ≤ 5.5V			13	
Shutdown Current	I _{SD}	EN = 0V, 1.7V ≤ V _{IN} ≤ 5.5V			3.5	µA
Quiescent Current	I _Q	1.7V ≤ V _{IN} ≤ 5.5V			270	µA
		V _{IN} = 3.6V		150		
Pull Down Resistance ⁽¹⁾	R _{PD}	SC33001A		1.1		kΩ
Turn On Time for SC33001A/AH	T _{ON}	From rising edge of EN to 50% of V _{OUT} , V _{IN} = 1.7V, Load = 10 Ω		1300		µs
		From rising edge of EN to 50% of V _{OUT} , V _{IN} = 3.6V, Load = 10 Ω		1300		
		From rising edge of EN to 50% of V _{OUT} , V _{IN} = 5.5V, Load = 10 Ω		1700		

Electrical Characteristics (continued)

Parameter	Symbol	Conditions	Min	Typ	Max	Units
Rise Time for SC33001A/AH	T_R	From 10% to 90% of VOUT, $V_{IN} = 1.7V$, Load = 10 Ω		630		μs
		From 10% to 90% of VOUT, $V_{IN} = 3.6V$, Load = 10 Ω		950		
		From 10% to 90% of VOUT, $V_{IN} = 5.5V$, Load = 10 Ω		1200		
Turn Off Time for SC33001A/AH	T_{OFF}	From falling edge of EN to 50% of VOUT, $V_{IN} = 1.7V$, Load = 10 Ω		75		μs
		From falling edge of EN to 50% of VOUT, $V_{IN} = 3.6V$, Load = 10 Ω		75		
		From falling edge of EN to 50% of VOUT, $V_{IN} = 5.5V$, Load = 10 Ω		75		
Fall Time for SC33001A/AH	T_F	From 90% to 10% of VOUT, $V_{IN} = 1.7V$, Load = 10 Ω		350		μs
		From 90% to 10% of VOUT, $V_{IN} = 3.6V$, Load = 10 Ω		350		
		From 90% to 10% of VOUT, $V_{IN} = 5.5V$, Load = 10 Ω		350		
EN Digital Input						
EN Input High Threshold	V_{IH}			0.9	1.05	V
EN Input Low Threshold	V_{IL}		0.4			V
Logic Input High Current	I_{IH}				0.1	μA
Logic Input Low Current	I_{IL}				0.1	μA
Protection						
Current Limit Threshold	I_{LIM}	Peak Current 1.7V $\leq V_{in} \leq 5.5V$, Rload=10m Ω , EN Rising	3	6	9	A
Foldback Current Limit	I_{LIM_FOLD}			2		A
Over Current Response Time	T_{ILIM}			100		μs
Thermal Shutdown Threshold	T_{th}			160		$^{\circ}C$
Thermal Shutdown Hysteresis	T_{hys}			38		$^{\circ}C$
Voltage Threshold Transition from ILIM_FOLD to ILIM	$V_{Rth_ILIM_TR}$			90%		VIN

Notes: (1) SC33001A: see Output Pull Down operation in Applications Information section.

Block Diagram

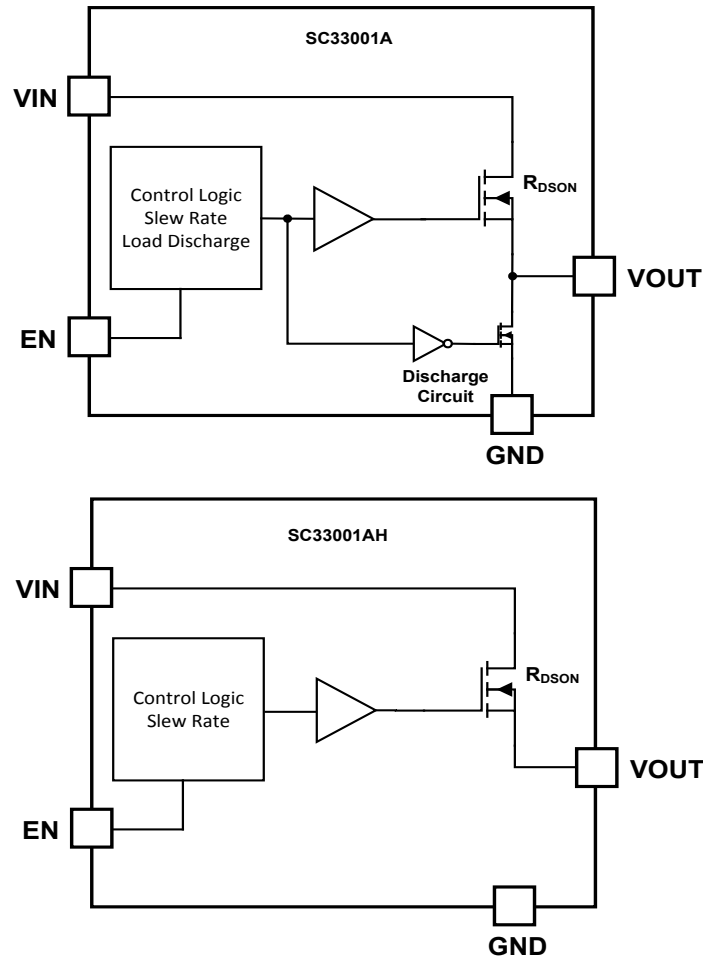

Pin Descriptions

Pin #	Pin Name	Pin Function
A1, B1	VOUT	Switch output - connect a bypass capacitor of at least 0.1uF to the GND pin. Minimize the PCB layout path inductance for this bypass capacitor between the VOUT pins and the GND pin.
A2, B2	VIN	Switch input - connect a bypass capacitor of at least 1uF to the GND pin. Minimize the PCB layout path inductance for this bypass capacitor between the VIN pins and the GND pin.
C1	GND	Ground reference.
C2	EN	Enable/disable.

Key Components

Component	Value	Manufacture	Part Number	Website
Input Capacitor	22uF/0603/X5R/10V	Murata	GRM188R61A226ME15	www.murata.com
Output Capacitor	22uF/0603/X5R/10V	Murata	GRM188R61A226ME15	www.murata.com

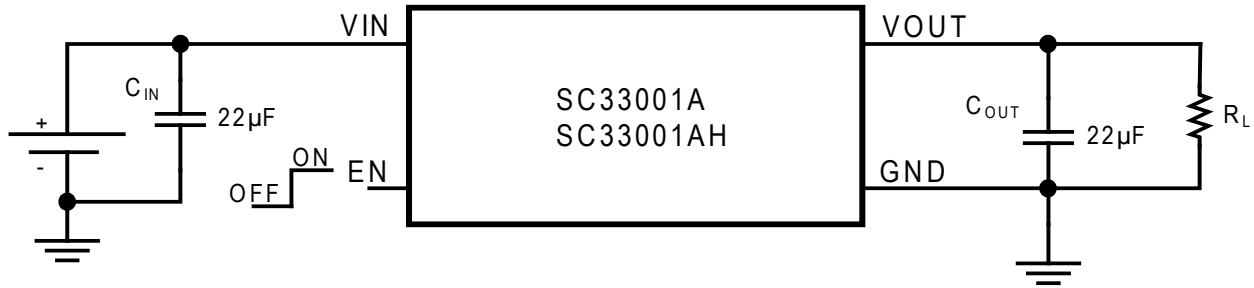
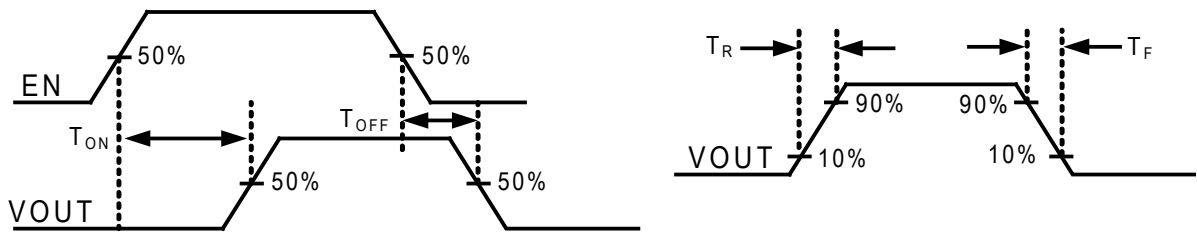
Parameter Measurement Information

TEST CIRCUIT

 T_{ON} , T_{OFF} , T_R , T_F WAVEFORMS

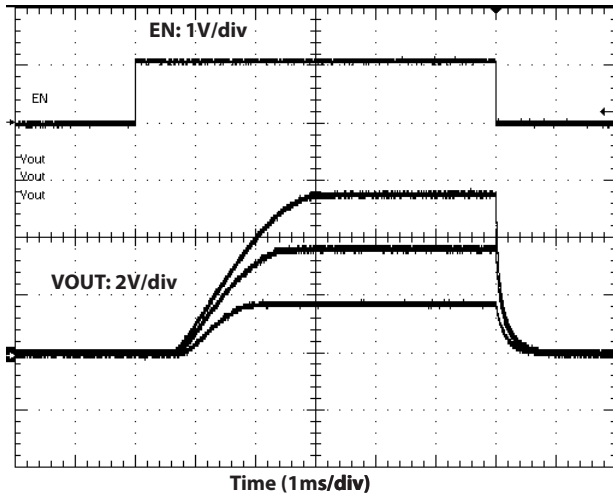
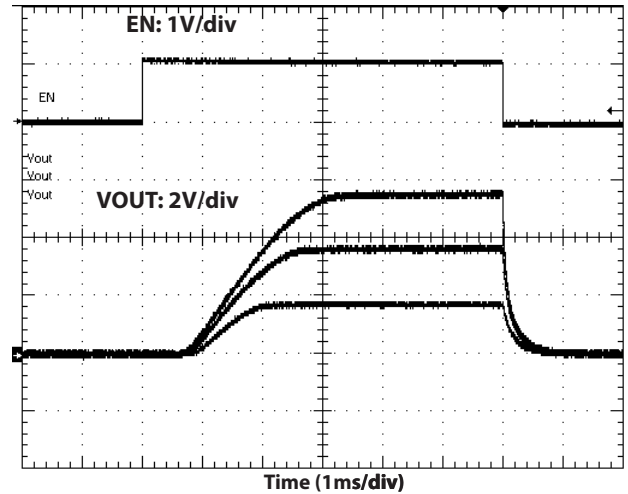
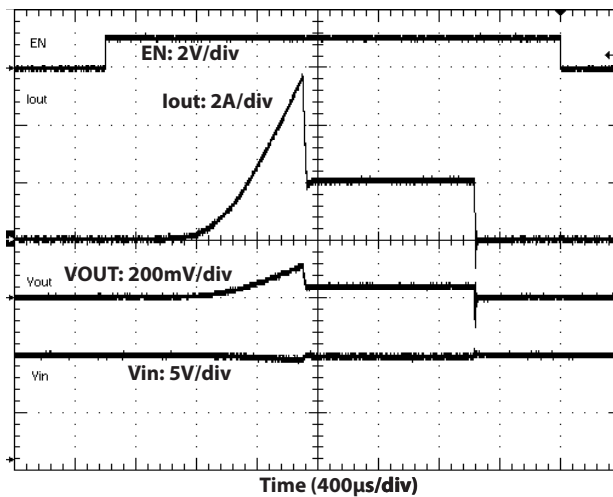
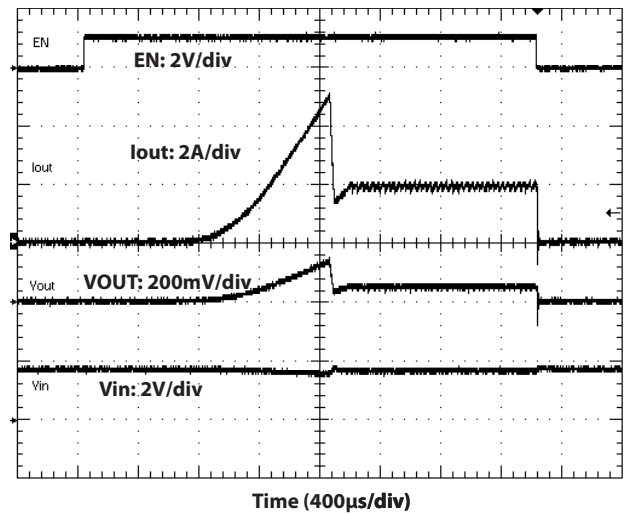
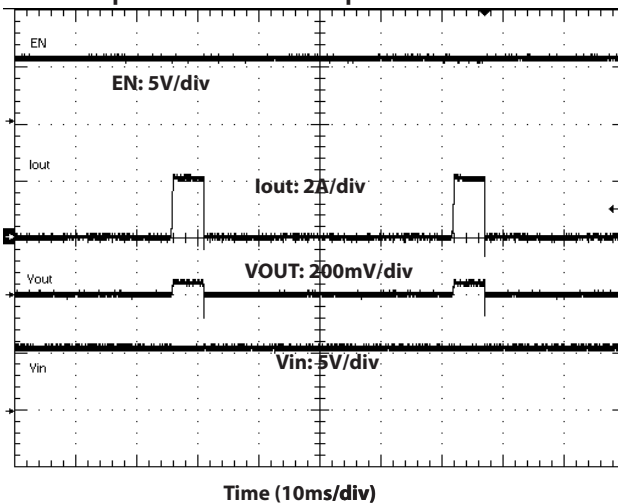
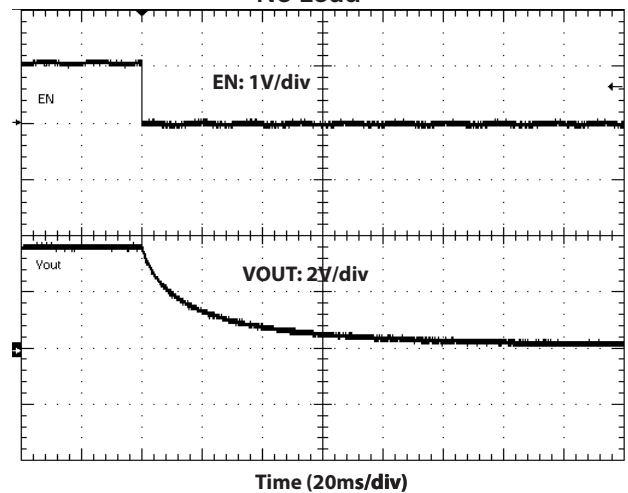
Typical Characteristics:

Characteristics in this section are based upon using SC33001A,AH evaluation board ($C_{IN} = 22\mu F + 1\mu F$, $C_{OUT} = 22\mu F + 1\mu F$).

SC33001AH, 10 Ohm Load, $V_{in}=1.7V, 3.6V, 5.5V$

SC33001A, 10 Ohm Load, $V_{in}=1.7V, 3.6V, 5.5V$

Enable to Short Circuit, $V_{in}=3.6V$, Device off due to OTP

Enable to Short Circuit, $V_{in}=1.7V$

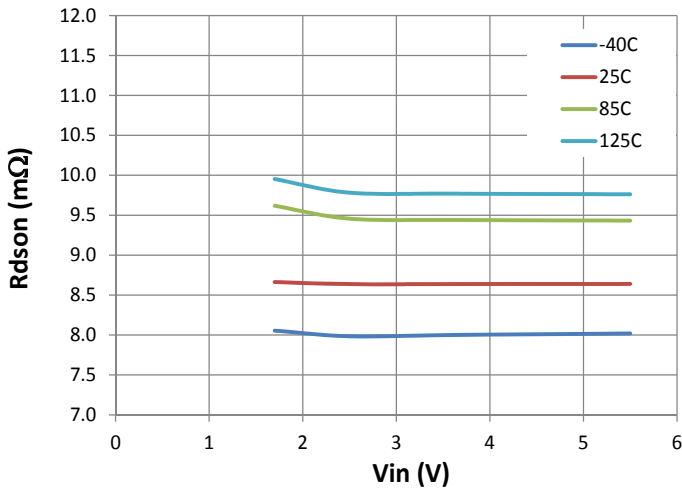
EN=High, $V_{in}=5.5V$, Short Circuit Operation Hiccup Due to Over Temperature Protection

Vout Disabled Operation: SC33001A, $V_{in}=3.6V$ No Load

Typical Characteristics:

Characteristics in this section are based upon using SC33001A, AH evaluation board ($C_{IN} = 22\mu F + 1\mu F$, $C_{OUT} = 22\mu F + 1\mu F$).

On Resistance (EN=VIN)



Quicent Current (0A Load)

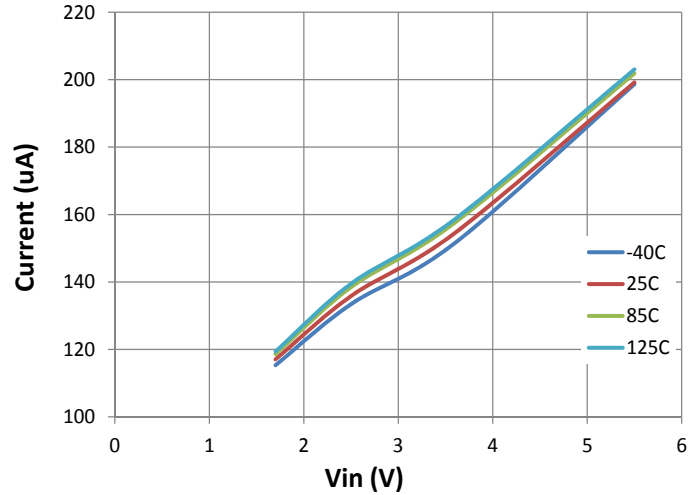

Turn-Off Time at 10 Ohm Load

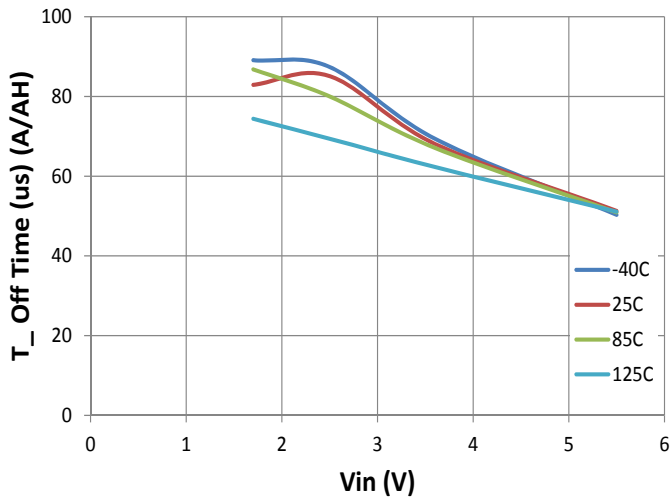

Fall Time at 10 Ohm Load

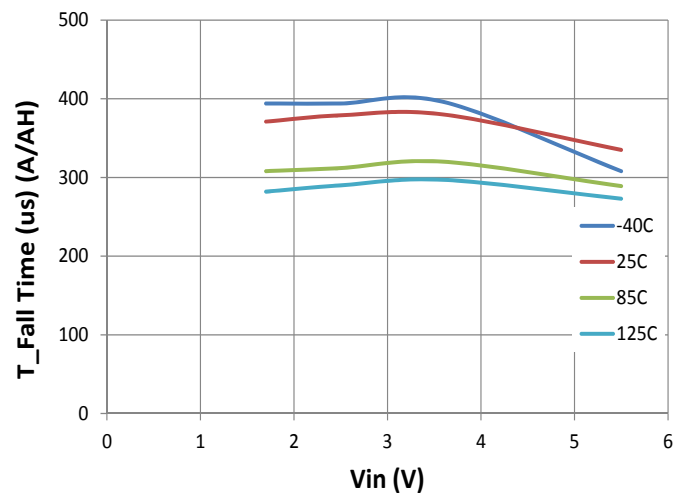

Rise Time at 10 Ohm Load

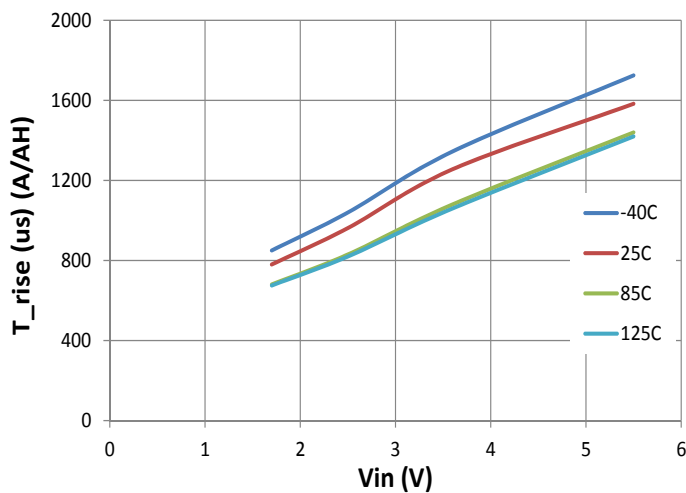

ON Time at 10 Ohm Load

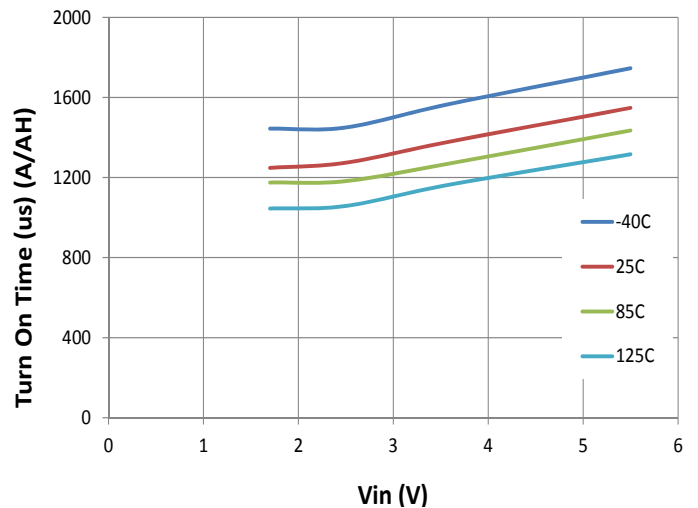

Typical Characteristics:

Characteristics in this section are based upon using SC33001A, AH evaluation board ($C_{IN} = 22\mu F + 1\mu F$, $C_{OUT} = 22\mu F + 1\mu F$).

EN Rising Threshold

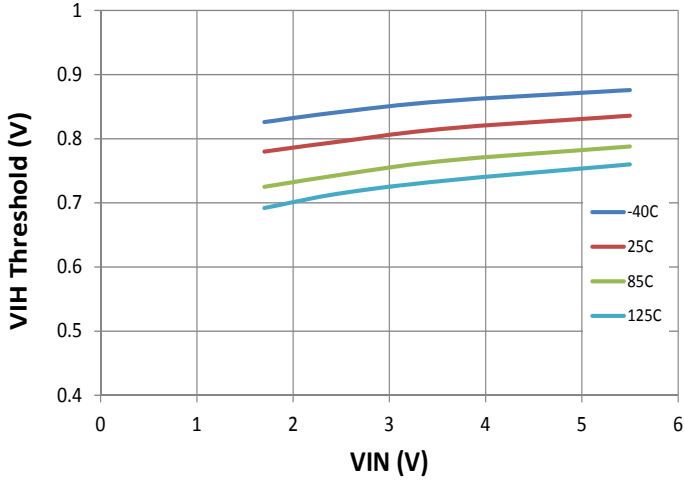

EN Falling Threshold

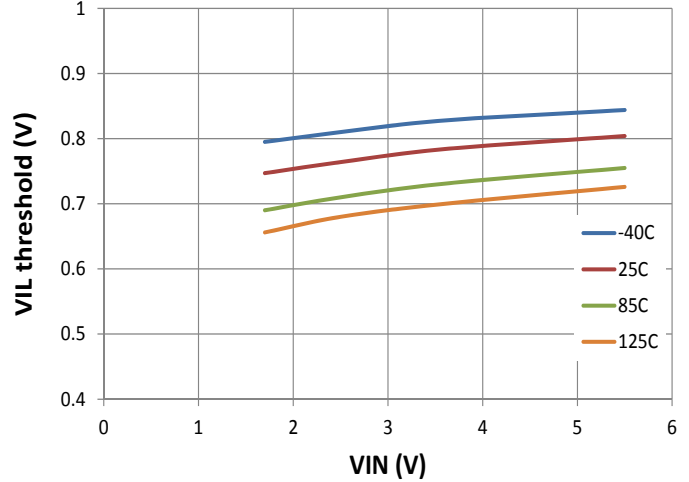

Short Circuit OCP Limit

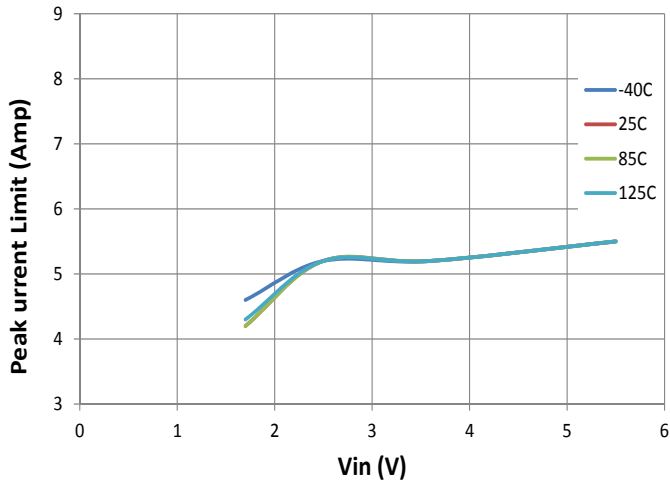

FOLD Back Current Limit

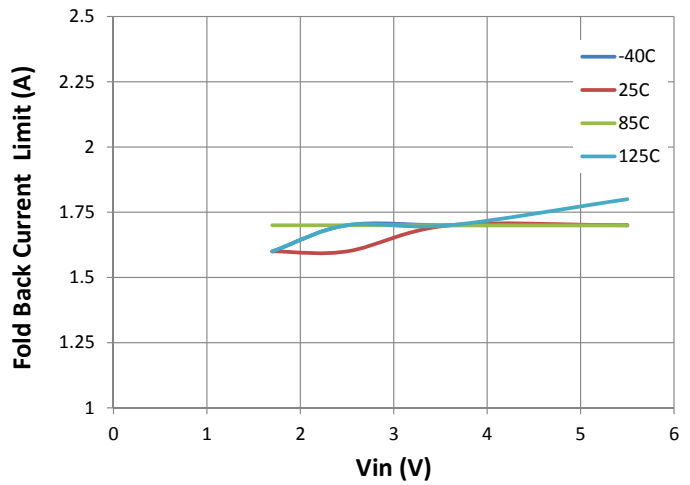

Delay Time from OCP to Foldback

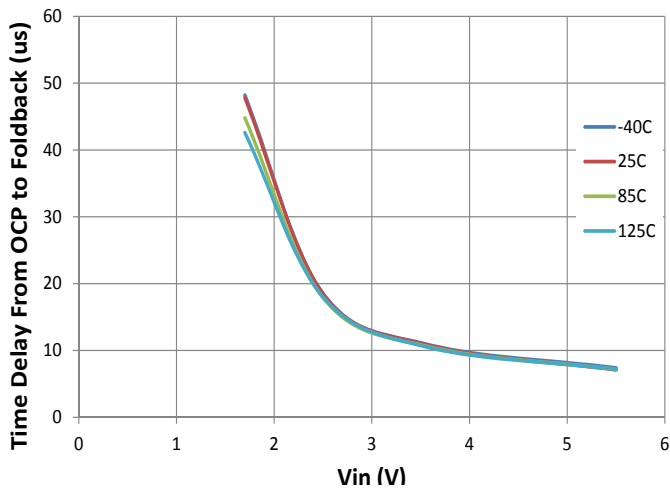

Vout Discharge Resistance After Off, Non-H Device

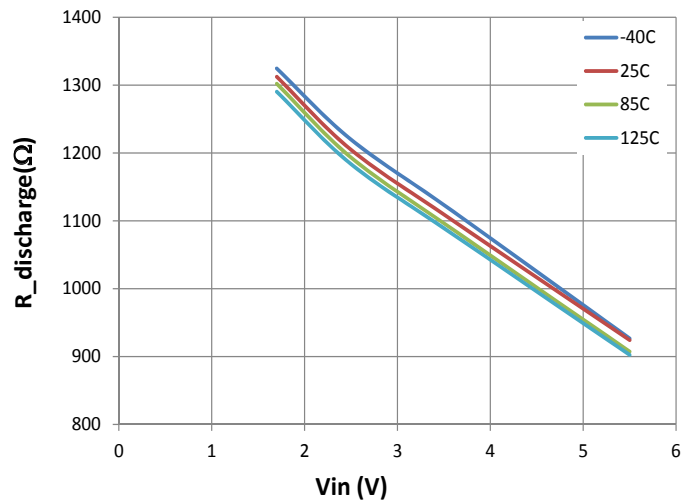

Applications Information

3A Load Switch

The SC33001A/AH are a family of an ultra-low $R_{ds(on)}$ load switch optimized for use in battery powered applications. This family of device supports up to 3A continuous output current. Sophisticated integrated circuitry maximizes V_{gs} of the power NMOS to minimize $R_{ds(on)}$ resistance over a wide range of operating conditions.

Input Capacitor

The primary purpose of input capacitance for SC33001A/AH is to hold the voltage at V_{in} pins constant when the switch is transition between open and closed. When the switch is closing, the input capacitor prevents the voltage at V_{in} from dropping. When the switch is opening, the input capacitor limits voltage spikes.

Ceramic capacitors should be derated for temperature and bias. As a result, applications up to 3.6V should use capacitors rated 6.3V. Applications up to 5.5V should use capacitors rated 10V.

Output Capacitor

The purpose of output capacitance is to absorb transients on the output. C_{in} should be selected to be higher in value than C_{out} . This is because the integrated body diode of the SC33001A/AH does not have reverse voltage protection. If the input supply is removed while the switch is closed, C_{in} higher than C_{out} helps prevent reverse bias of the integrated body diode.

Use the same voltage rating criteria for the output capacitor as the input capacitor as described in above section.

Output Voltage Pull-down

The SC33001A has an internal pull-down resistor. When the SC33001A is disabled, the output pull-down resistor discharges the output capacitor through 1.1 k Ω .

Protection

The SC33001A/AH have current limit protection (OCP). Current limit is quickly invoked when V_{in} current exceeds current limit threshold (I_{LIM}). The current limit is then folded back to current limit foldback (I_{LIM_FOLD}). This fold back limit will be held for about 100 μ s before it can be released back to it's full value current limit (I_{LIM}). The decision to raise current limit back to it's full value is based on the voltage at V_{out} . If the voltage on V_{out} is approxi-

mately 90% of V_{in} ($V_{Rth_ILIM_TR}$) and the part has been in foldback for the minimum time, then current limit is returned to it's full value (I_{LIM}).

Startup into a short circuit behavior is illustrated in Figure 1. As the switch current increases beyond the over-current protection threshold, the device will go into foldback current limit. The current is regulated to the reduced foldback current limit level. Upon the short circuit removal, as the load current is smaller than the foldback current limit, the output voltage will rise. When the output voltage rises to \sim 90% of V_{in} , current limit will return to the normal over-current protection level and resume normal operation.

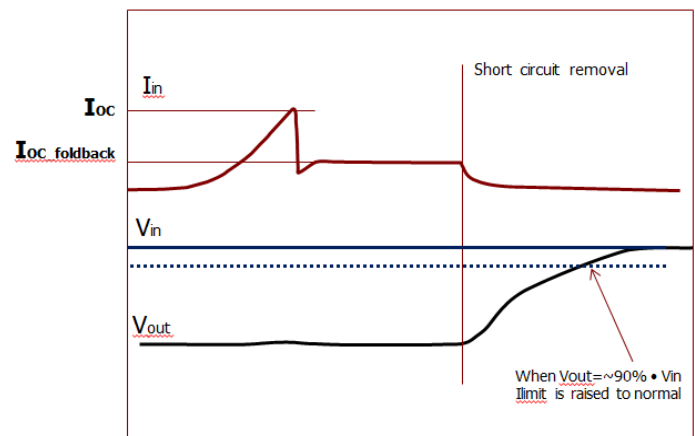

Figure 1 — Startng into Short Circuit and Recovery from Short Circuit Removal Behavior

SC33001A/AH have over-temperature protection (OTP). If the junction temperature rises to a typical value of 160 degree (T_{th}), the device will shutdown. Once the temperature drops by about 38 degree (T_{hys}), the device will restart automatically. In case the output is shorted and OTP has been triggered, the restart or hiccup mode operation current limit will be held at fold back current limit (I_{LIM_FOLD}), refer to the waveform in page 7.

With a permanent short circuit on the output, the device junction temperature will be “regulated” by the OTP circuits. The temperature will cychel between T_{th} and ($T_{th}-T_{hys}$) with alternate operation of current limit at I_{LIM_FOLD} and shutdown modes.

Applications Information

PCB Layout

Figure 2 shows the typical application circuit with PCB inductance on the circuit board. An important objective of the layout is to minimize the PCB inductance by reducing the length and increasing the width of the traces. The input and output capacitors need to be placed close to the SC33001A/AH. The PCB inductance only effects the performance during the turn-on, turn-off and load transients. Figure 2 shows three current loops during the opening or closing of the switch. The magnitude of the voltage ringing at VIN or VOUT pin depends on the value of PCB inductance and placement of the capacitors. It is important to keep the voltage below the maximum rating of the SC33001A/AH.

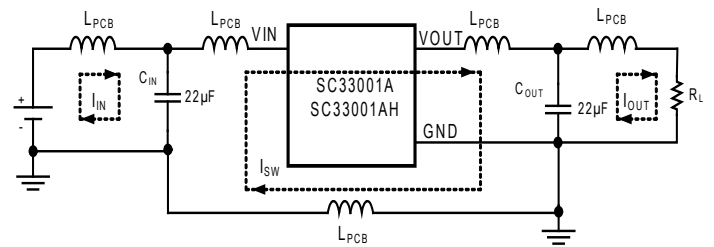
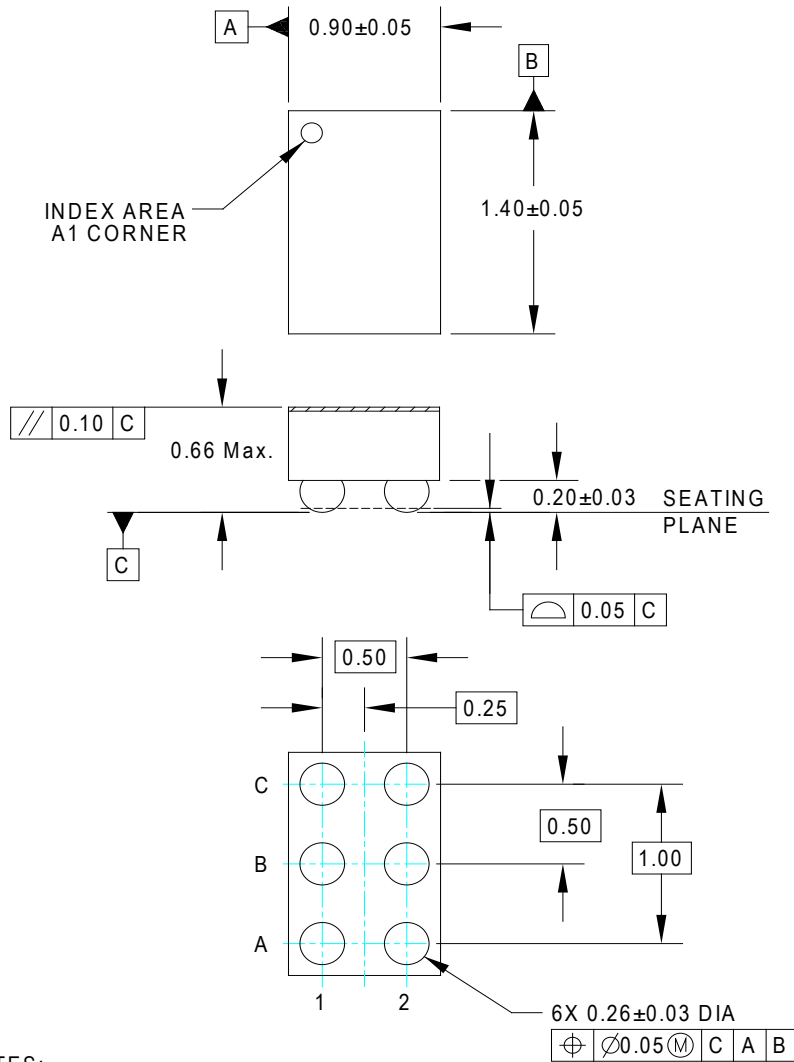
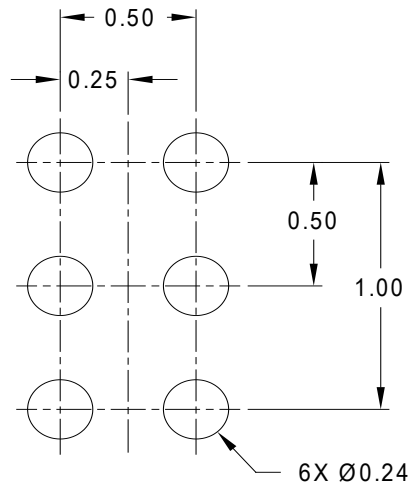

Figure 2 — Parasitic Inductance Loops on a PCB Board, Inductance Needs to be Minimized in Layout by Placing Input and Output Capacitor Close to IC.

Outline Drawing — CSP 0.9mm x 1.4mm, 6-Bump

NOTES:

1. CONTROLLING DIMENSIONS ARE IN MILLIMETERS

Land Pattern Drawing — CSP 0.9mm x 1.4mm, 6-Bump



NOTES:

1. CONTROLLING DIMENSIONS ARE IN MILLIMETERS
2. THIS LAND PATTERN IS FOR REFERENCE PURPOSES ONLY. CONSULT YOUR MANUFACTURING GROUP TO ENSURE YOUR COMPANY'S MANUFACTURING GUIDELINES ARE MET.