



Mallory Sonalert Products, Inc.

Part #: **SCE048XD2DB2S**

Sales Outline Drawing

Revision: **A**

Specifications:

Sound Level Category:	Extra Loud	Loud	Extra Loud	Loud
Mode of Operation:	Continuous	Continuous	Medium Pulse	Medium Pulse
Pulse Rate (PPS):	N/A	N/A	5	5
Loudness @ 2 FT:	95 to 105 dB(A) Typ.	85 to 95 dB(A) Typ.	95 to 105 dB(A) Typ.	85 to 95 dB(A) Typ.
Frequency:	2000 ± 500 Hz	2000 ± 500 Hz	2000 ± 500 Hz	2000 ± 500 Hz
Connection:	TERMINALS ONLY	TERMINALS; BLUE WIRE TO (-)	TERMINALS; YELLOW WIRE TO (-)	TERMINALS; BOTH WIRES TO (-)
Voltage Rating:	28 to 48 VDC			
Current Draw:	40mA MAX			
Housing Material:	6/6 Nylon, Color: Black			
Storage Temperature:	-40° to +85° C			
Operating Temperature:	-40° to +85° C			
Panel Mounting:	Recommended hole size is 1.25"(31.75mm). Thread front will fit standard 30mm(1.181") hole.			
Knurled Nut:	Used to attach part to panel. The max recommended torque is 10 in-lbs.			
Weight (Typical):	2.1 oz (60g)			
NEMA 3R,4X, & 12:	Approved with use of ACC03.			
cUL Recognition:	cUL Recognized			
Options:	Please contact factory.			

Dimensions: Inches (mm)

ROHS Compliant

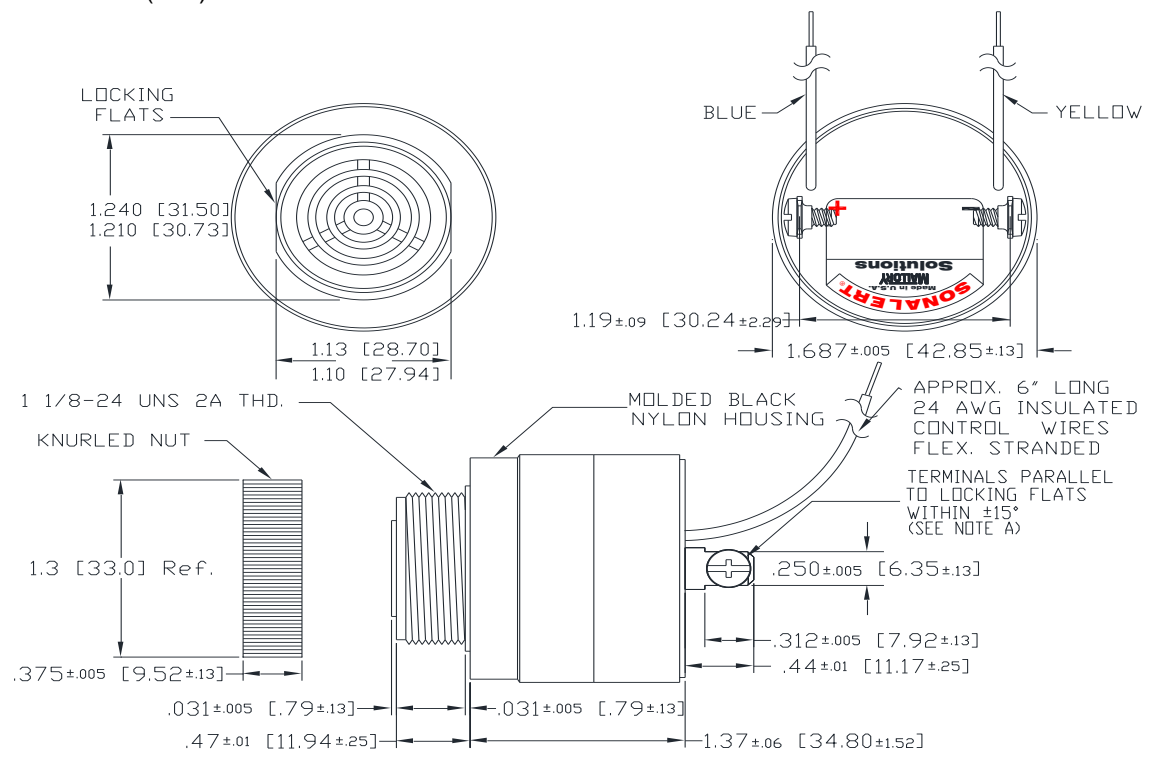

NOTE A: TERMINALS-.032 BRASS TIN PLATED, TAPPED FOR #6-32 SCREW. TWO #6-32 NICKEL PLATED BRASS SCREWS INCLUDED. WILL ACCEPT 1/4" QUICK CONNECT.

NOTE B: MOUNTING- REMOVE BLACK PLASTIC NUT AND INSERT THREADED FRONT THROUGH 1.25" HOLE PUNCHED IN PANEL, IF ORIENTATION IS NEEDED, NOTE LOCKING FLATS ON DRAWING. SCREW NUT BACK ON. DO NOT OVERTIGHTEN.