

# SCM Series

## Series-Connected Super Capacitor Modules

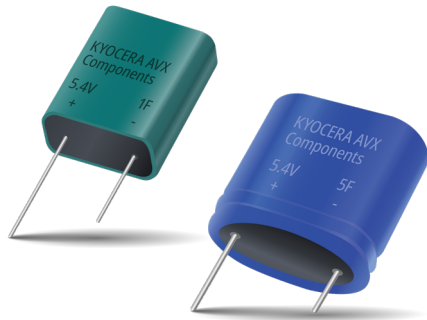

This new series of electrochemical, double-layer, series-connected SuperCapacitor modules offers excellent pulse power handling characteristics based on the combination of very high capacitance and very low ESR. Used by themselves or in conjunction with primary or secondary batteries, they provide extended back up time, longer battery life, and provide instantaneous power pulses as needed. Offers great solutions to hold up, energy harvesting, pulse power applications, and battery replacement.

### FEATURES

- High Pulse Power Capability
- Low ESR
- Low Leakage Current
- Plastic, Moisture Resistant Version

### APPLICATIONS

- Camera Flash Systems
- Energy Harvesting
- GSM/GPRS Pulse Applications
- UPS/Industrial
- Wireless Alarms
- Remote Metering
- Scanners
- Toys and Games

### HOW TO ORDER

<b>SCM</b>	<b>R</b>	<b>14</b>	<b>C</b>	<b>474</b>	<b>P</b>	<b>R</b>	<b>B</b>	<b>A</b>	<b>0</b>
Series SuperCap Module	Diameter Q = 6.3mm R = 8mm / 9.5mm** S = 10mm T = 12.5mm U = 16mm	Case Length Two digits represent case length in mm	Voltage Code C = 5.0V D = 5.4V F = 5.5V G = 7.5V H = 6.0V J = 8.1V L = 9.0V	Capacitance Code 1st two digits represent significant figures 3rd digit represents multiplier (number of zeros to follow)	Tolerance P = +100%/-0% S = +30%/-10%	Package/Lead Format R = Shrink Wrap/Radial S = Plastic/Radial	Package B = Bulk T = Tray*	Balancing A = Unbalanced B = Passive Balanced	Lead Orientation 0 = Straight Leads 1 = Bent Leads*
								*Inquire about availability **Plastic/Radial version	

### QUALITY INSPECTION

Parts are tested for life cycle, high temperature load life, temperature characteristics, vibration resistance, and humidity characteristics. See pages 2-5 for more information.

### TERMINATION

These SuperCapacitors are compatible with hand soldering and wave soldering processes, so long as appropriate precautions are followed. See 12 for more information.



For RoHS compliant products, please select correct termination style.

## 5.4V/5.0V Series-Connected SuperCapacitors Modules

Part Number	Diameter (mm)	Length (mm)	Rated Capacitance (F)	Capacitance Tolerance	Rated Voltage (V)	Rated Temperature (°C)	DCL Max @ 72 Hrs (µA)	ESR Max @ 1000 Hz (mΩ)	ESR Max @ DC (mΩ)	Peak Current (A)	Power Density (W/kg)	Max Energy (Wh)	Energy Density (Wh/kg)
<b>Shrink Wrap / Radial Lead</b>													
SCMQ14C474PRBA0	6.3	14	0.47	+100%/-0%	5.0/4.2*	65/85*	3	400	1000	0.80	2143	0.0016	1.17
SCMQ14C474PRTA0	6.3	14	0.47	+100%/-0%	5.0/4.2*	65/85*	3	400	1000	0.80	2143	0.0016	1.17
SCMQ14D474PRBB0	6.3	14	0.47	+100%/-0%	5.4/4.6*	65/85*	6	400	1000	0.86	2499	0.0019	1.36
SCMQ14D474PRTB0	6.3	14	0.47	+100%/-0%	5.4/4.6*	65/85*	6	400	1000	0.86	2499	0.0019	1.36
SCMR14C474PRBA0	8	14	0.47	+100%/-0%	5.0/4.2*	65/85*	5	300	1000	0.80	1429	0.0016	0.78
SCMR14D474PRBB0	8	14	0.47	+100%/-0%	5.4/4.6*	65/85*	6	300	1000	0.86	1666	0.0019	0.91
SCMR18C105PRBA0	8	18	1	+100%/-0%	5.0/4.2*	65/85*	8	200	720	1.45	1667	0.0035	1.39
SCMR18D105PRBB0	8	18	1	+100%/-0%	5.4/4.6*	65/85*	10	200	720	1.57	1944	0.0041	1.62
SCMR22C155PRBA0	8	22	1.5	+100%/-0%	5.0/4.2*	65/85*	10	190	580	2.01	1669	0.0052	1.68
SCMR22D155PRBB0	8	22	1.5	+100%/-0%	5.4/4.6*	65/85*	15	190	580	2.17	1946	0.0061	1.96
SCMS22C255PRBA0	10	22	2.5	+100%/-0%	5.0/4.2*	65/85*	20	140	360	3.29	1852	0.0087	1.93
SCMS22D255PRBB0	10	22	2.5	+100%/-0%	5.4/4.6*	65/85*	25	140	360	3.55	2113	0.0101	2.20
SCMT22C505PRBA0	12.5	22	5	+100%/-0%	5.0/4.2*	65/85*	25	100	150	7.14	2740	0.0174	2.38
SCMT22D505PRBB0	12.5	22	5	+100%/-0%	5.4/4.6*	65/85*	30	100	150	7.71	3069	0.0203	2.66
SCMT32C755SRBA0	12.5	32	7.5	+30%/-10%	5.0/4.2*	65/85*	65	70	160	8.52	1953	0.0260	2.71
SCMT32D755SRBB0	12.5	32	7.5	+30%/-10%	5.4/4.6*	65/85*	70	70	160	9.20	2209	0.0304	3.07

\*with appropriate voltage derating operating temperature can be extended to 85°C

### OPERATING TEMPERATURE RANGE

-40°C to +65°C @ 5.4V Balanced, 5.0V Unbalanced  
 -40°C to +85°C @ 4.6V Balanced, 4.2V Unbalanced

### QUALIFICATION TEST SUMMARY

Test	Test Method	Parameter	Limits
Life Cycle	Capacitors are cycled between rated voltage and half-rated voltage under constant current at +25°C for 500,000 cycles	Capacitance ESR Appearance	≤30% of spec value ≤200% of spec value No remarkable defects
High Temperature Load Life	Temperature: +65°C Voltage: Rated Voltage Test Duration: 1,000 hours	Capacitance ESR Appearance	≤30% of spec value ≤200% of spec value No remarkable defects
Storage Temperature Characteristics	Storage Duration: 2 years No Load Temperature: +35°C	Capacitance ESR Appearance	≤30% of spec value ≤200% of spec value No remarkable defects
Vibration Resistance	Amplitude: 1.5mm Frequency: 10 ~ 55Hz Direction: X, Y, Z for 2 hours each	Capacitance ESR Appearance	≤30% of spec value ≤200% of spec value No remarkable defects
Humidity	Voltage: Rated Voltage RH: 90% Temperature: +60°C Test Duration: 1,000 hours	Capacitance ESR Appearance	≤30% of spec value ≤200% of spec value No remarkable defects

Part Number	Diameter (mm)	Length (mm)	Rated Capacitance (F)	Capacitance Tolerance	Rated Voltage (V)	Rated Temperature (°C)	DCL Max @ 72 Hrs (µA)	ESR Max @ 1000 Hz (mΩ)	ESR Max @ DC (mΩ)	Peak Current (A)	Power Density (W/kg)	Max Energy (Wh)	Energy Density (Wh/kg)
<b>Shrink Wrap / Radial Lead</b>													
SCMQ14F474PRBA0	6.3	14	0.47	+100%/-0%	5.5/4.6*	65/85*	6	500	3000	0.54	864	0.0020	1.41
SCMQ14H474PRBB0	6.3	14	0.47	+100%/-0%	6.0/5.0*	65/85*	7	500	3000	0.59	1029	0.0024	1.68
SCMR14F474PRBA0	8	14	0.47	+100%/-0%	5.5/4.6*	65/85*	6	380	1720	0.71	1005	0.0020	0.94
SCMR14H474PRBB0	8	14	0.47	+100%/-0%	6.0/5.0*	65/85*	7	380	1720	0.78	1196	0.0024	1.12
SCMR18F105PRBA0	8	18	1	+100%/-0%	5.5/4.6*	65/85*	9	250	720	1.60	2017	0.0042	1.68
SCMR18H105PRBB0	8	18	1	+100%/-0%	6.0/5.0*	65/85*	11	250	720	1.74	2400	0.0050	2.00
SCMR22F155PRBA0	8	22	1.5	+100%/-0%	5.5/4.6*	65/85*	12	200	560	2.24	2091	0.0063	2.03
SCMR22H155PRBB0	8	22	1.5	+100%/-0%	6.0/5.0*	65/85*	18	200	560	2.45	2488	0.0075	2.42
SCMS22F255PRBA0	10	22	2.5	+100%/-0%	5.5/4.6*	65/85*	24	180	340	3.72	2373	0.0105	2.33
SCMS22H255PRBB0	10	22	2.5	+100%/-0%	6.0/5.0*	65/85*	30	180	340	4.05	2762	0.0125	2.72
SCMS32F505PRBA0	10	32	5	+100%/-0%	5.5/4.6*	65/85*	30	120	150	7.86	3580	0.0210	3.11
SCMS32H505PRBB0	10	32	5	+100%/-0%	6.0/5.0*	65/85*	36	120	150	8.57	4235	0.0250	3.68
SCMT22F505PRBA0	12.5	22	5	+100%/-0%	5.5/4.6*	65/85*	30	120	150	7.86	3176	0.0210	2.76
SCMT32F755SRBA0	12.5	32	7.5	+30%/-10%	5.5/4.6*	65/85*	78	90	120	10.86	3151	0.0315	3.28
SCMT32H755SRBB0	12.5	32	7.5	+30%/-10%	6.0/5.0*	65/85*	84	90	120	11.84	3600	0.0375	3.75
SCMU33F156SRBA0	16	33	15	+30%/-10%	5.5/4.6*	65/85*	85	35	50	23.57	4033	0.0630	3.50
SCMU33F156SRBB0	16	33	15	+30%/-10%	5.5/4.6*	65/85*	90	35	50	23.57	3946	0.0630	3.43
<b>Plastic / Radial Lead</b>													
SCMR14F474PSBA0	9.5	16	0.47	+100%/-0%	5.5/4.6*	65/85*	6	380	1720	0.71	541	0.0020	0.51
SCMR14H474PSBB0	9.5	16	0.47	+100%/-0%	6.0/5.0*	65/85*	7	380	1720	0.78	644	0.0024	0.60
SCMR18F105PSBA0	9.5	20	1	+100%/-0%	5.5/4.6*	65/85*	9	250	720	1.60	1096	0.0042	0.91
SCMR18H105PSBB0	9.5	20	1	+100%/-0%	6.0/5.0*	65/85*	11	250	720	1.74	1304	0.0050	1.09
SCMR22F155PSBA0	9.5	24	1.5	+100%/-0%	5.5/4.6*	65/85*	12	200	560	2.24	1179	0.0063	1.15
SCMR22H155PSBB0	9.5	24	1.5	+100%/-0%	6.0/5.0*	65/85*	18	200	560	2.45	1403	0.0075	1.36

### OPERATING TEMPERATURE RANGE

-40°C to +65°C @ 6.0V Balanced, 5.5V Unbalanced  
 -40°C to +85°C @ 5.0V Balanced, 4.6V Unbalanced

### QUALIFICATION TEST SUMMARY

Test	Test Method	Parameter	Limits
Life Cycle	Capacitors are cycled between rated voltage and half-rated voltage under constant current at +25°C for 500,000 cycles	Capacitance ESR Appearance	≤30% of spec value ≤200% of spec value No remarkable defects
High Temperature Load Life	Temperature: +65°C Voltage: Rated Voltage Test Duration: 1,000 hours	Capacitance ESR Appearance	≤30% of spec value ≤200% of spec value No remarkable defects
Storage Temperature Characteristics	Storage Duration: 2 years No Load Temperature: +35°C	Capacitance ESR Appearance	≤30% of spec value ≤200% of spec value No remarkable defects
Vibration Resistance	Amplitude: 1.5mm Frequency: 10 ~ 55Hz Direction: X, Y, Z for 2 hours each	Capacitance ESR Appearance	≤30% of spec value ≤200% of spec value No remarkable defects
Humidity	Voltage: Rated Voltage RH: 90% Temperature: +60°C Test Duration: 1,000 hours	Capacitance ESR Appearance	≤30% of spec value ≤200% of spec value No remarkable defects

## 7.5V Series-Connected Super Capacitor Modules

Part Number	Diameter (mm)	Length (mm)	Rated Capacitance (F)	Capacitance Tolerance	Rated Voltage (V)	Rated Temperature (°C)	DCL Max @ 72 Hrs (µA)	ESR Max @ 1000 Hz (mΩ)	ESR Max @ DC (mΩ)	Peak Current (A)	Power Density (W/kg)	Max Energy (Wh)	Energy Density (Wh/kg)
<b>Shrink Wrap / Radial Lead</b>													
SCMR14G334SRBA0	8	14	0.33	+30%/-10%	7.5/6.4*	65/85*	6	450	900	0.95	2419	0.0026	0.83
SCMR14G334SRBB0	8	14	0.33	+30%/-10%	7.5/6.4*	65/85*	7	450	900	0.95	2419	0.0026	0.83
SCMR18G604SRBA0	8	18	0.6	+30%/-10%	7.5/6.4*	65/85*	9	225	450	1.77	3947	0.0047	1.23
SCMR18G604SRBB0	8	18	0.6	+30%/-10%	7.5/6.4*	65/85*	11	225	450	1.77	3846	0.0047	1.20
SCMR22G105SRBA0	8	22	1	+30%/-10%	7.5/6.4*	65/85*	10	180	360	2.76	4076	0.0078	1.70
SCMR22G105SRBB0	8	22	1	+30%/-10%	7.5/6.4*	65/85*	15	180	360	2.76	3989	0.0078	1.66

\*with appropriate voltage derating operating temperature can be extended to 85°C

### OPERATING TEMPERATURE RANGE

-40°C to +65°C @ 7.5V  
 -40°C to +85°C @ 6.4V

### QUALIFICATION TEST SUMMARY

Test	Test Method	Parameter	Limits
<b>Life Cycle</b>	Capacitors are cycled between rated voltage and half-rated voltage under constant current at +25°C for 500,000 cycles	Capacitance ESR Appearance	≤30% of spec value ≤200% of spec value No remarkable defects
<b>High Temperature Load Life</b>	Temperature: +65°C Voltage: Rated Voltage Test Duration: 1,000 hours	Capacitance ESR Appearance	≤30% of spec value ≤200% of spec value No remarkable defects
<b>Storage Temperature Characteristics</b>	Storage Duration: 2 years No Load Temperature: +35°C	Capacitance ESR Appearance	≤30% of spec value ≤200% of spec value No remarkable defects
<b>Vibration Resistance</b>	Amplitude: 1.5mm Frequency: 10 ~ 55Hz Direction: X, Y, Z for 2 hours each	Capacitance ESR Appearance	≤30% of spec value ≤200% of spec value No remarkable defects
<b>Humidity</b>	Voltage: Rated Voltage RH: 90% Temperature: +60°C Test Duration: 1,000 hours	Capacitance ESR Appearance	≤30% of spec value ≤200% of spec value No remarkable defects

## 9.0V/8.1V Series-Connected Super Capacitor Modules

Part Number	Diameter (mm)	Length (mm)	Rated Capacitance (F)	Capacitance Tolerance	Rated Voltage (V)	Rated Temperature (°C)	DCL Max @ 72 Hrs (µA)	ESR Max @ 1000 Hz (mΩ)	ESR Max @ DC (mΩ)	Peak Current (A)	Power Density (W/kg)	Max Energy (Wh)	Energy Density (Wh/kg)
<b>Shrink Wrap / Radial Lead</b>													
SCMR14J334SRBA0	8	14	0.33	+30%/-10%	8.1/6.9*	65/85*	6	500	2850	0.69	897	0.0030	0.98
SCMR14J334SRBB0	8	14	0.33	+30%/-10%	8.1/6.9*	65/85*	7	500	2850	0.69	869	0.0030	0.95
SCMR14L334SRBB0	8	14	0.33	+30%/-10%	9.0/7.6*	65/85*	7	500	2850	0.77	1072	0.0037	1.17
SCMR18J604SRBA0	8	18	0.6	+30%/-10%	8.1/6.9*	65/85*	9	400	1080	1.47	1934	0.0055	1.45
SCMR18J604SRBB0	8	18	0.6	+30%/-10%	8.1/6.9*	65/85*	12	400	1080	1.47	1869	0.0055	1.40
SCMR18L604SRBB0	8	18	0.6	+30%/-10%	9.0/7.6*	65/85*	12	400	1080	1.64	2308	0.0068	1.73
SCMR22J105SRBA0	8	22	1	+30%/-10%	8.1/6.9*	65/85*	12	350	840	2.20	1986	0.0091	1.93
SCMR22J105SRBB0	8	22	1	+30%/-10%	8.1/6.9*	65/85*	15	350	840	2.20	1894	0.0091	1.84
SCMR22L105SRBB0	8	22	1	+30%/-10%	9.0/7.6*	65/85*	18	350	840	2.45	2338	0.0113	2.27
<b>Plastic / Radial Lead</b>													
SCMR14J334SSBA0	9.5	16	0.33	+30%/-10%	8.1/6.9*	65/85*	6	500	2850	0.69	498	0.0030	0.54
SCMR14L334SSBB0	9.5	16	0.33	+30%/-10%	9.0/7.6*	65/85*	7	500	2850	0.77	598	0.0037	0.65
SCMR18J604SSBA0	9.5	20	0.6	+30%/-10%	8.1/6.9*	65/85*	9	400	1080	1.47	1063	0.0055	0.80
SCMR18L604SSBB0	9.5	20	0.6	+30%/-10%	9.0/7.6*	65/85*	12	400	1080	1.64	1286	0.0068	0.96
SCMR22J105SSBA0	9.5	24	1	+30%/-10%	8.1/6.9*	65/85*	12	350	840	2.20	1129	0.0091	1.10
SCMR22L105SSBB0	9.5	24	1	+30%/-10%	9.0/7.6*	65/85*	18	350	840	2.45	1361	0.0113	1.32

### OPERATING TEMPERATURE RANGE

-40°C to +65°C @ 9.0V Balanced, 8.1V Unbalanced  
 -40°C to +85°C @ 7.6V Balanced, 6.9V Unbalanced

### QUALIFICATION TEST SUMMARY

Test	Test Method	Parameter	Limits
Life Cycle	Capacitors are cycled between rated voltage and half-rated voltage under constant current at +25°C for 500,000 cycles	Capacitance ESR Appearance	≤30% of spec value ≤200% of spec value No remarkable defects
High Temperature Load Life	Temperature: +65°C Voltage: Rated Voltage Test Duration: 1,000 hours	Capacitance ESR Appearance	≤30% of spec value ≤200% of spec value No remarkable defects
Storage Temperature Characteristics	Storage Duration: 2 years No Load Temperature: +35°C	Capacitance ESR Appearance	≤30% of spec value ≤200% of spec value No remarkable defects
Vibration Resistance	Amplitude: 1.5mm Frequency: 10 ~ 55Hz Direction: X, Y, Z for 2 hours each	Capacitance ESR Appearance	≤30% of spec value ≤200% of spec value No remarkable defects
Humidity	Voltage: Rated Voltage RH: 90% Temperature: +60°C Test Duration: 1,000 hours	Capacitance ESR Appearance	≤30% of spec value ≤200% of spec value No remarkable defects

### QUALITY AND RELIABILITY

CAPACITANCE VS. TEMPERATURE

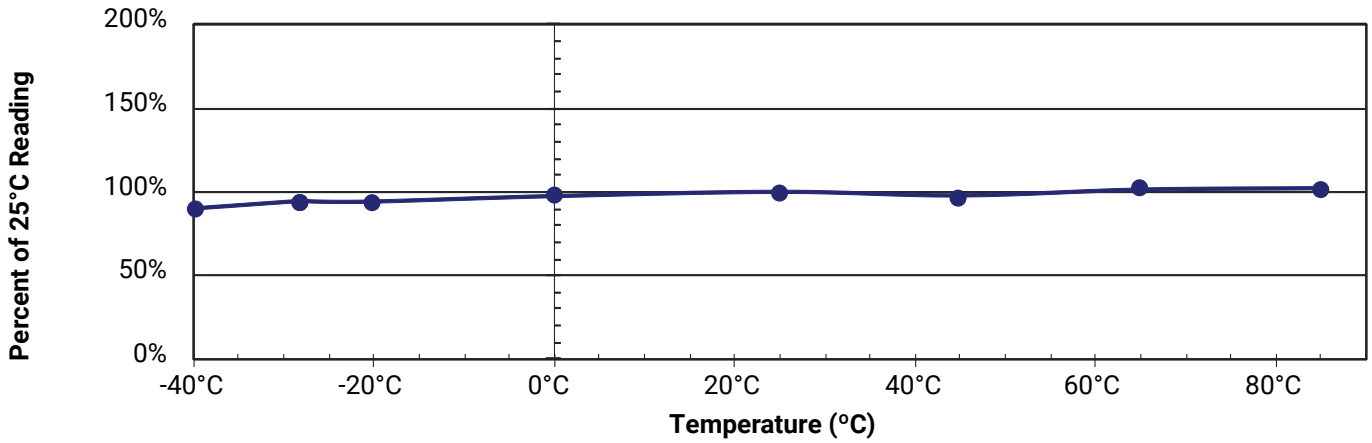

LEAKAGE CURRENT VS. TEMPERATURE

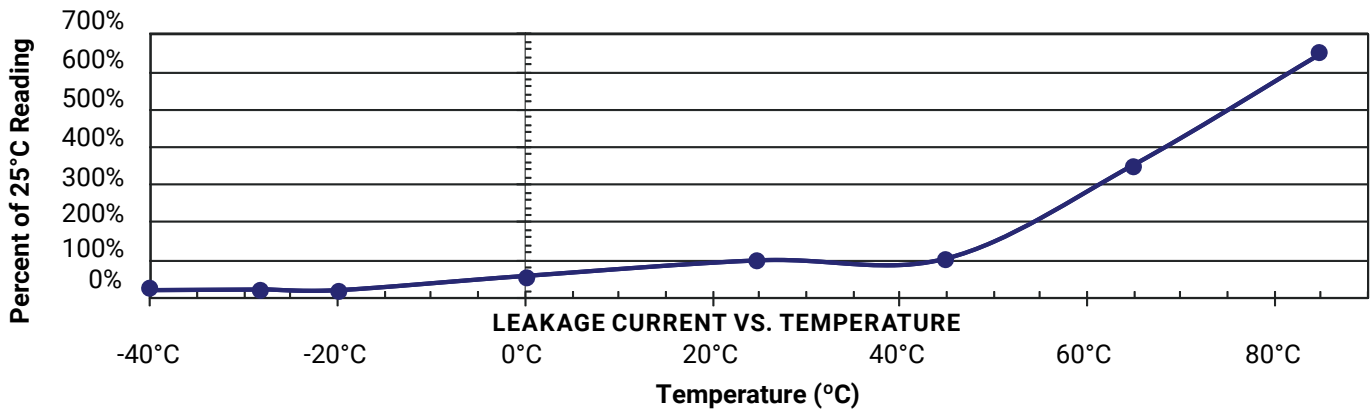

EQUIVALENT SERIES RESISTANCE VS. TEMPERATURE

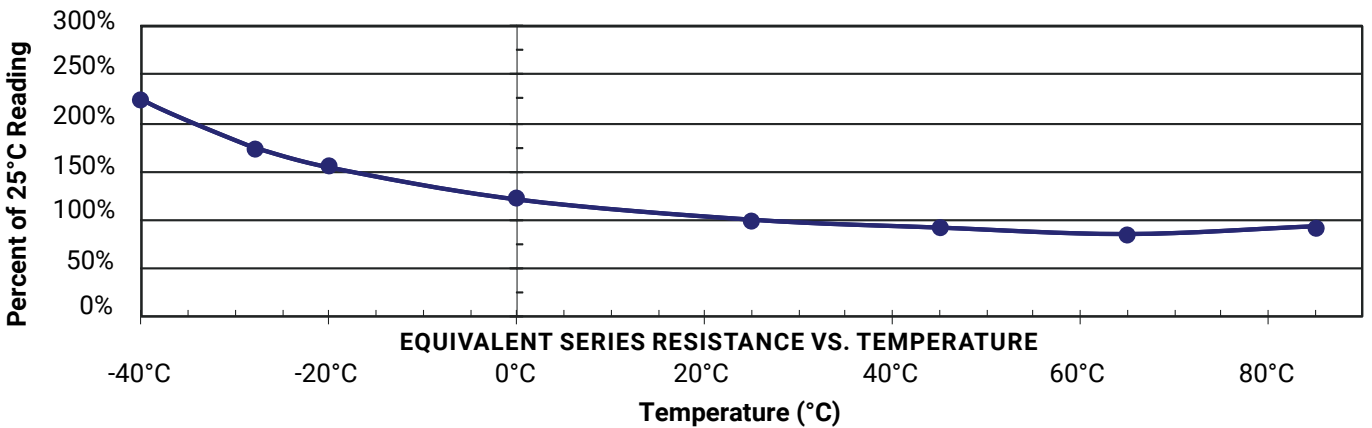

# SCM Series

## Series-Connected Super Capacitor Modules



### MECHANICAL SPECIFICATIONS

#### 5.4V, 6.0V SHRINK WRAP TYPE - STRAIGHT LEADS

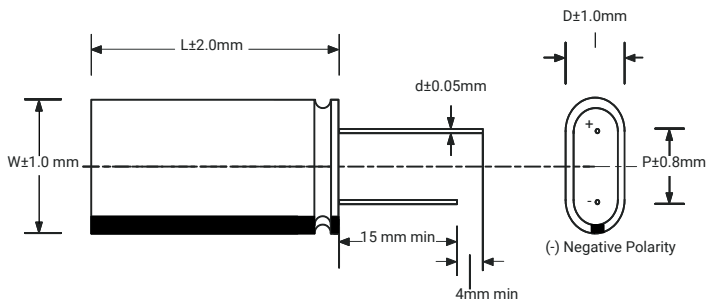

#### 5.4V, 6.0V SHRINK WRAP TYPE - BENT LEADS

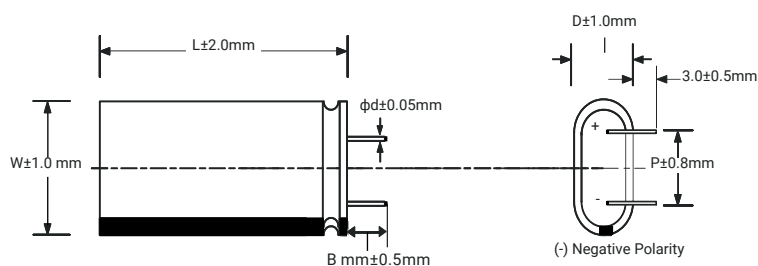

Cap (F)	D (mm)	W (mm)	L (mm)	P (mm)	d (mm)	B (mm)*
0.47	6.3	13.6	14.0	9.0	0.6	2.0
0.47	8.0	16.0	14.0	11.5	0.6	2.0
1	8.0	16.0	18.0	11.5	0.6	2.0
1.5	8.0	16.0	22.0	11.5	0.6	2.0
2.5	10.0	20.0	22.0	15.5	0.6	2.0
5	10.0	20.0	32.0	15.5	0.6	2.0
5	12.5	25.0	22.0	18.0	0.6	2.0
7.5	12.5	25.0	32.0	18.0	0.6	2.0
15	16.0	32.0	33.0	23.7	0.8	2.0

\*for version with bent leads

#### 7.5V, 9.0V SHRINK WRAP TYPE - STRAIGHT LEADS

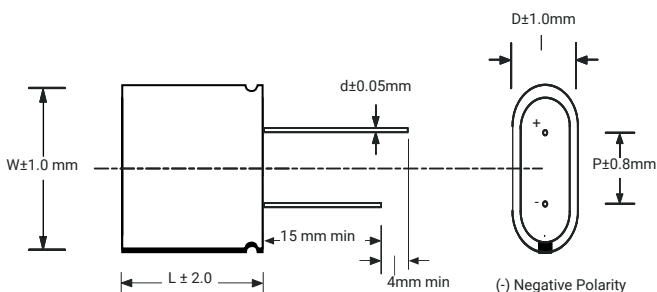

#### 7.5V, 9.0V SHRINK WRAP TYPE - BENT LEADS

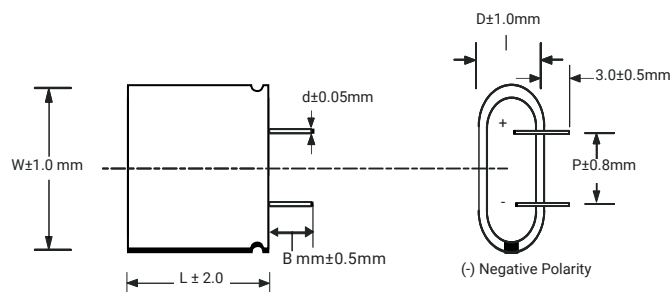

Cap (F)	D (mm)	W (mm)	L (mm)	P (mm)	d (mm)	B (mm)*
0.33	8.0	24.0	14.0	13.5	0.6	2.0
0.6	8.0	24.0	18.0	13.5	0.6	2.0
1	8.0	24.0	22.0	13.5	0.6	2.0

\*for version with bent leads

### MECHANICAL SPECIFICATIONS

#### 6.0V PLASTIC TYPE - STRAIGHT LEADS

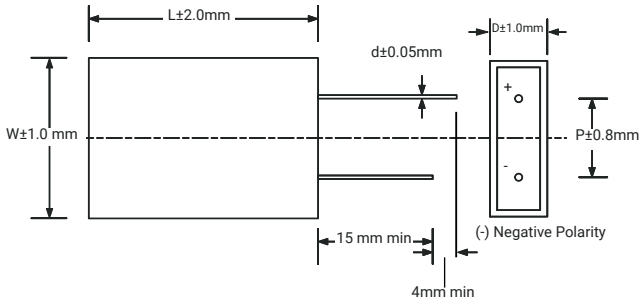

#### 6.0V PLASTIC TYPE - BENT LEADS

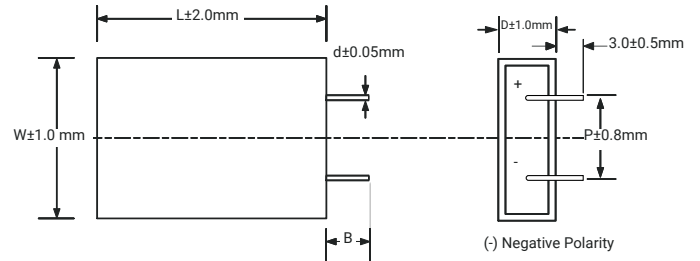

Cap (F)	D (mm)	W (mm)	L (mm)	P (mm)	d (mm)	B (mm)*
0.47	9.5	18.5	16.0	11.5	0.6	2.0
1	9.5	18.5	20.0	11.5	0.6	2.0
1.5	9.5	18.5	24.0	11.5	0.6	2.0

\*for version with bent leads

#### 9.0V PLASTIC TYPE - STRAIGHT LEADS

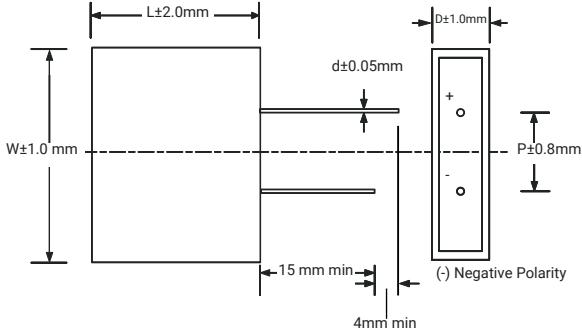

#### 9.0V Plastic Type - Bent Leads

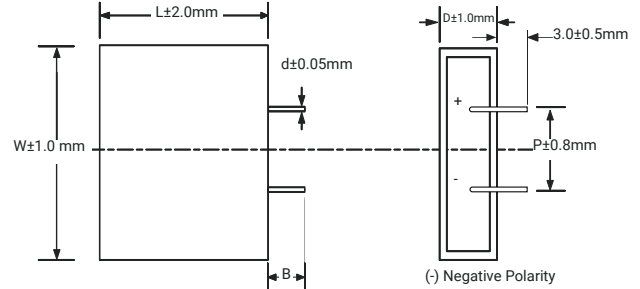

Cap (F)	D (mm)	W (mm)	L (mm)	P (mm)	d (mm)	B (mm)*
0.33	9.5	26.6	16.0	13.5	0.6	2.0
0.6	9.5	26.6	20.0	13.5	0.6	2.0
1	9.5	26.6	24.0	13.5	0.6	2.0

\*for version with bent leads



### TEST METHODS

#### IEC CAPACITANCE TEST METHOD

Procedure: Charge module under constant current to rated voltage at room temperature, then hold 10 minutes on charge under constant voltage. After 10 minutes, discharge under constant current (as shown in chart below), recording voltage at  $V_1$ ,  $V_2$ , and time intervals at  $t_1$  and  $t_2$ . Use the capacitance formula to determine cap value.

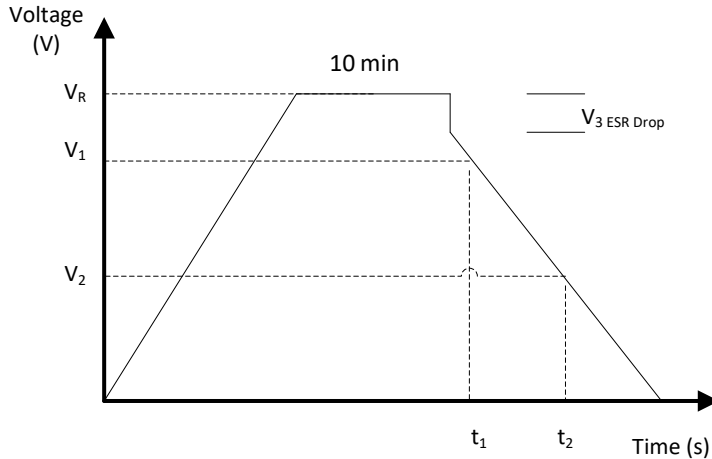

$I$  – Discharge Current,  $4 \times C \times V_R$  (mA)

$V_R$  – Rated Voltage (V)

$V_1$  – Initial Test Voltage, 80% Of  $V_R$  (V)

$V_2$  – Final Test Voltage, 40% Of  $V_R$  (V)

$t_1$  – Initial Test Time (s)

$t_2$  – Final Test Time (s)

$$C = \frac{I \times (t_2 - t_1)}{V_1 - V_2}$$

#### DC ESR MEASUREMENT

A six-step ESR<sub>DC</sub> test method is illustrated to the right and carried out as follows:

- Rest 10 Seconds
- Charge under constant current ( $I_1$ ) to rated voltage ( $V_R$ )
- Rest 5 seconds
- Rest 10 seconds, record  $V_3$  and  $t_4$
- Discharge under constant current ( $I_2$ ) to half rated voltage, Record  $I_2$ ,  $V_4$ , And  $t_5$
- Rest 2 seconds, record  $V_5$  And  $t_6$

Repeat steps 1-6 recording  $I$ ,  $V$ , And  $t$  accordingly, finally discharging to below 0.1V under constant current ( $I_2$ ).

Formulas to calculate:

• Two cycle discharge capacitances:  $C_{dch1} = I_2 \times \frac{(t_5 - t_4)}{V_3 - V_4}$ ;  $C_{dch2} = I_2 \times \frac{(t_{11} - t_{10})}{(V_9 - V_{10})}$

• Discharge capacitance:  $C_{dch} = \frac{(C_{dch1} + C_{dch2})}{2}$

• Two cycle discharge DC ESR:  $ESR_{dch1} = \frac{(V_5 - V_4)}{I_2}$ ;  $ESR_{dch2} = \frac{(V_{11} - V_{10})}{I_2}$

• Discharge DC ESR:  $ESR_{dch} = \frac{(ESR_{dch1} + ESR_{dch2})}{2}$

Note:  $I_1 = I_2 = 75mA/F$ , the rated capacitance in the chart means discharge capacitance, and DC ESR ( $ESR_{DC}$ ) means discharge DC resistance.

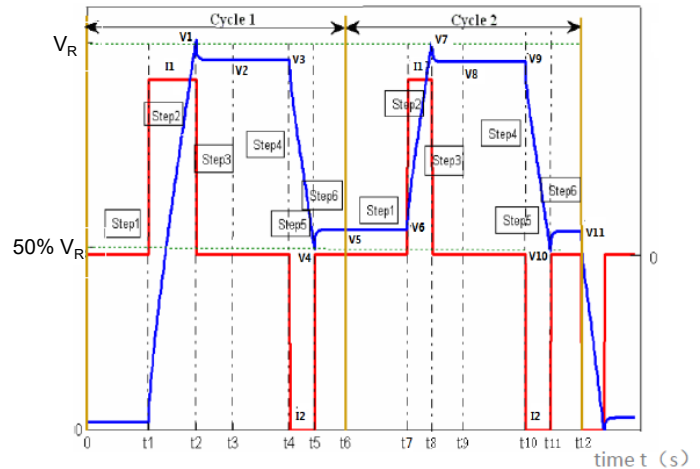

# SCM Series

## Series-Connected Super Capacitor Modules

### TEST METHODS (continued)

#### MAXIMUM CONTINUOUS CURRENT

- This is the maximum current when temperature rise of the supercapacitor during its operation is less than 15°C

#### MAXIMUM PEAK CURRENT

- This is the maximum current during 1 second time interval (dt)

#### WATT DENSITY

- Watt Density =  $(0.12 \cdot V^2 / R_{DC}) / \text{mass}$

#### ENERGY DENSITY

- Energy Density =  $(\frac{1}{2} CV^2) / (3600 \cdot \text{mass})$

### POLARITY AND REVERSE VOLTAGE

For product consistency and optimum performance, it is recommended that the capacitor be connected with polarity indicated. Reversing polarity could result in permanent damage to the circuit including much higher leakage current for a short duration of time and the life time of the supercapacitors will be reduced.

### LIFE TIME AND TEMPERATURE PERFORMANCE

The life of a supercapacitor is impacted by a combination of operating voltage and the operating temperature according to the following Time to Failure equation:

$$t \propto V^n \times e^{\left(\frac{-Q}{kT}\right)}$$

where V is the operating voltage, Q is the activation energy in electron volts (eV), k is the Boltzmann constant in eV, and T is the operating temperature in Kelvin (K). Typical values for the voltage exponent, n, is between 2.5-3.5, and Q is between 1.0-1.2 eV in the normal operating temperature range of -40° to 65°C.

The industry standard for supercapacitor end of life is when the equivalent series resistance, ESR, increases to 200% of the specified value and the capacitance drops by 30% from specified value. Typically a supercapacitor shows an initial “jump” in the ESR value and then levels off. If the supercapacitors are exposed to excessive temperatures the ESR will show a continuous degradation (increase). In the extreme case, if the temperature or voltage are substantially higher than the rated specifications, this could result in the part venting and the product showing a faster degradation of capacitance and ESR, which may be many times the specified value.

# SCM Series

## Series-Connected Super Capacitor Modules



Expected Lifetime at Various Voltages  
SCM Series

