

SDAH01

Evaluation Kit for the HS3001 Humidity and Temperature Sensor

The SDAH01 Evaluation Kit is used to assess the HS3001 High-Performance Relative Humidity and Temperature Sensor. The hardware allows users to perform data logging experiments, and it can communicate through a standard USB interface with the user’s computer using the Demo Software. This software can be used to view measurements in real-time, adjust the resolution of the sensor, configure measurement parameters, and download previously logged measurements.

The evaluation board can be powered directly from the USB port of the user’s computer or from a 1632 coin cell battery to enable fully autonomous (untethered) data logging.

Features

- Relative Humidity Sensor Module with HS3001 sensor module:
 - RH accuracy: $\pm 1.5\%RH$
 - Operating temperature: -40 to $105^{\circ}C$
- Demo Software:
 - Data plotter
 - Measurement resolution configuration
 - Data export
- Sensor module extension cable allows extending the HS3001 Sensor Module to different measurement areas

Board Contents

- SDAH01 evaluation board
- Three HS3001 sensor modules
- Sensor module extension cable
- USB cable

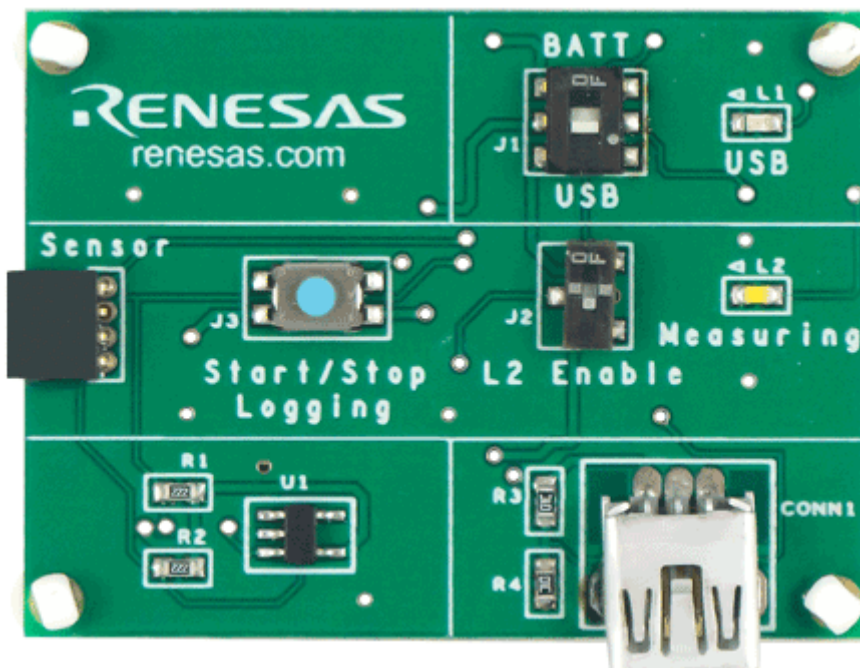

Figure 1. SDAH01 Evaluation Kit

Contents

1. Functional Description	3
1.1 Setup and Configuration.....	3
1.1.1. Computer Requirements.....	3
1.1.2. Software Installation and Setup	3
1.2 Kit Hardware Connections.....	4
2. Using the EVK	5
2.1 Measurement Settings.....	5
2.2 Exporting Data	6
2.3 Data Logging Mode (Untethered)	6
2.4 Data Logging Settings	7
2.5 Using the Plotter	7
2.6 Valid Settings Ranges	7
3. Ordering Information	7
4. Revision History	7

Figures

Figure 1. SDAH01 Evaluation Kit	1
Figure 2. Initial Display after Installation of the Demo Software.....	3
Figure 3. Evaluation Kit Connections	4
Figure 4. Start Measurements	4
Figure 5. Measurement Settings	5
Figure 6. Set Resolution	5
Figure 7. Battery Installation	6
Figure 8. Download Data to Demo Software	6

1. Functional Description

1.1 Setup and Configuration

1.1.1. Computer Requirements

A Windows®-based computer is required for interfacing with the kit and configuring the device. The user must have administrative rights on the computer to install the Renesas Demo Software for the kit.

The computer must meet the following minimum systems requirements:

- CPU – Intel or compatible
- RAM – 512MB
- Operating system – Windows® XP / Vista / 7 / 8 / 10
- Ports – One available USB port

1.1.2. Software Installation and Setup

Complete the following procedure to install the Demo Software:

1. Plug in the USB flash drive to start the setup.
2. If the setup process does not start automatically, double-click on the *Setup.exe* file.

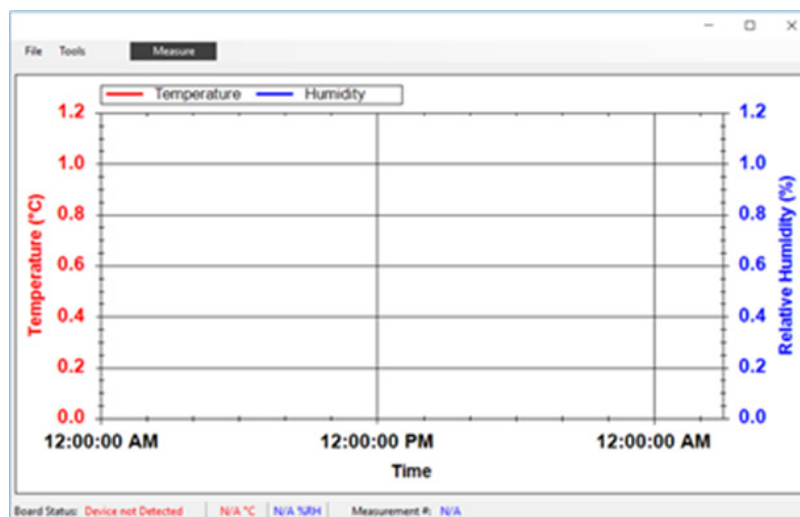

Figure 2. Initial Display after Installation of the Demo Software

1.2 Kit Hardware Connections

Complete the following procedure to set up the kit as shown in Figure 3:

1. Install the software from the USB flash drive or download from renesas.com as described in Software Installation and Setup.
2. Connect one of the HS3001 sensor modules facing up, with or without the extension cable attached, into the sensor module connector ①.
3. Connect the USB port ② of the board to the user’s computer using the supplied USB cable, and ensure that the power switch ③ on the board is in the USB position. The “USB” LED ④ will light.
4. Run the Demo Software package from the Start menu, and click on the “Measure” button ⑤. The “Measuring” indicator ⑥ will blink whenever data is being captured.

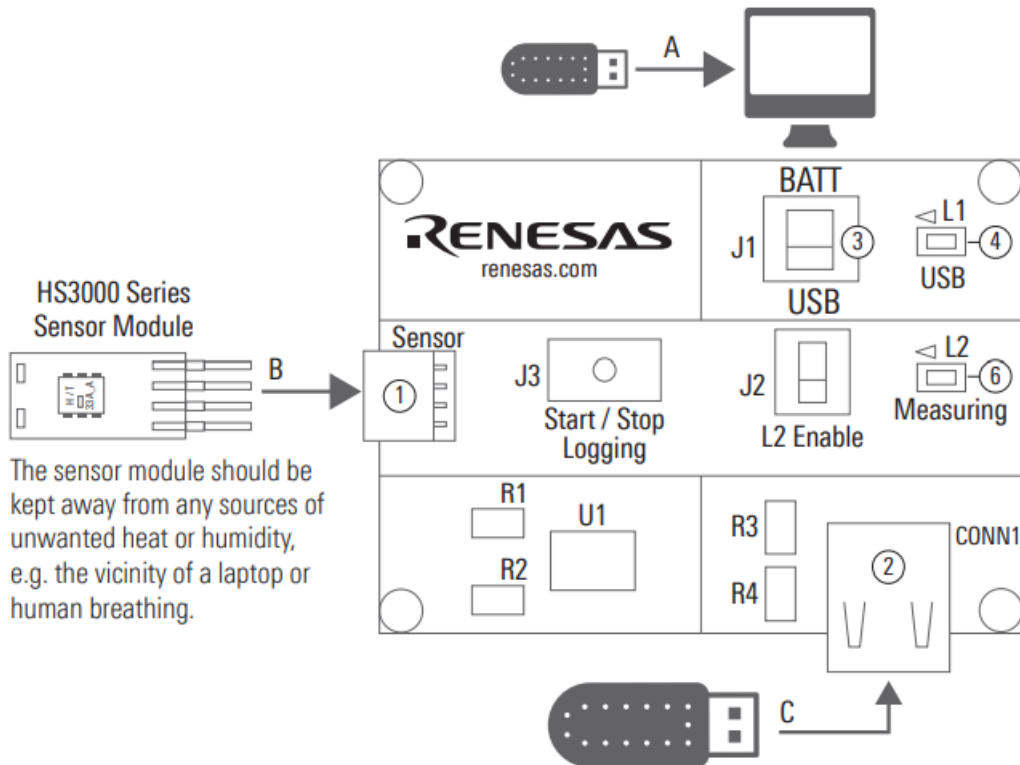

Figure 3. Evaluation Kit Connections

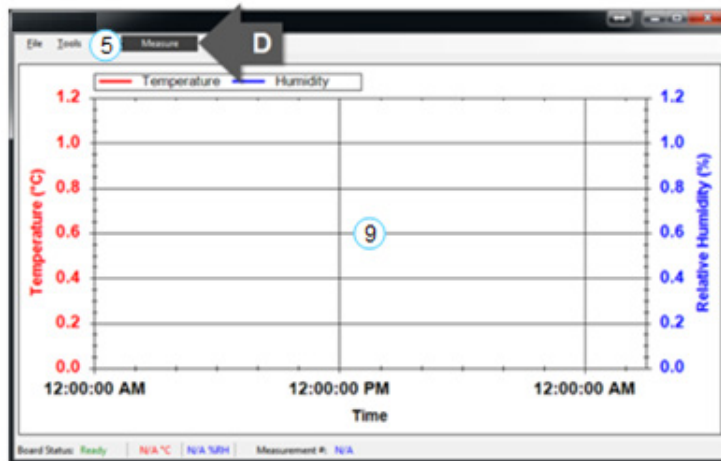

Figure 4. Start Measurements

2. Using the EVK

2.1 Measurement Settings

To change the interval and number of measurements to be made, select *Measurement Settings* from the *Tools* menu, enter the desired values, and then click OK, as shown in Figure 5. For the range of valid settings for these two entry fields, see Valid Settings Ranges.

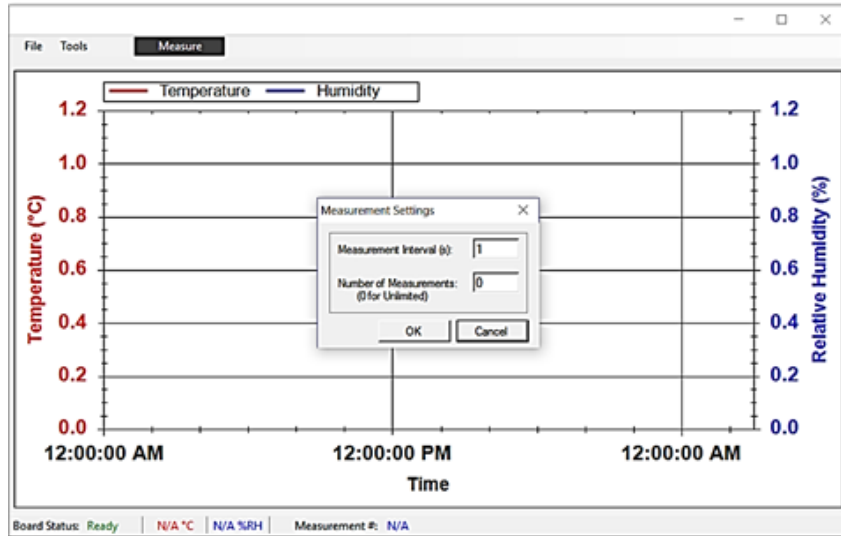

Figure 5. Measurement Settings

To change the measurement resolution, select *Set Resolution* from the *Tools* menu, select the desired resolution, and then click OK, as shown in Figure 6. The resolution setting is stored on the sensor, and it will be the default value applied when measurements are started. Measurement settings can be changed only when no measurements are being taken.

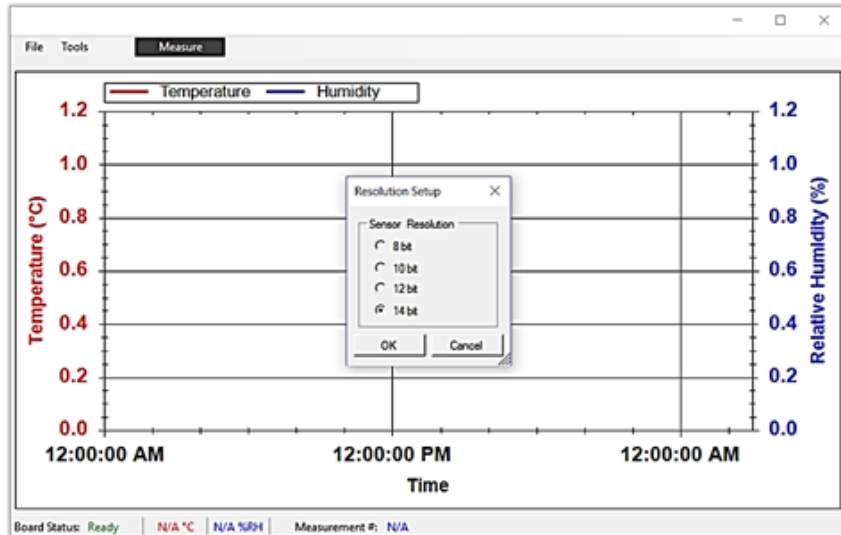

Figure 6. Set Resolution

2.2 Exporting Data

The data displayed in the plotter area can be exported in two different formats.

- To export the measured data points in a Microsoft Excel® compatible comma-separated text file, select *Save Data* from the *File* menu. Create a filename for the data, and select the location where the file will be saved.
- To export the plots themselves as a picture file, right-click on the plot area and select *Save Image As*. Create a file name, select the location, and select the file type for the image.

2.3 Data Logging Mode (Untethered)

Disconnect the kit from the computer. Ensure that a battery is inserted in the battery holder on the back of the board with the positive battery terminal facing away from the board, as shown in Figure 7.

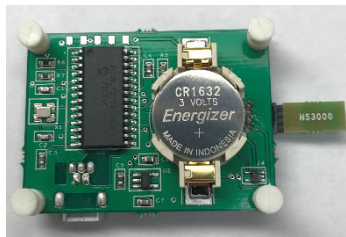

Figure 7. Battery Installation

Complete the following to operate the kit in the data logging mode (see Figure 2).

1. To set the board to the data logging mode, put the power switch ③ in the “Batt” position.
2. To start data logging, hold the “Start/Stop Logging” button ⑦ for 3 seconds. The “Measuring” indicator ⑥ will light for 2 seconds and then start blinking on every logged measurement. This can be disabled to extend the battery life by toggling the “L2 Enable” switch ⑧.
3. To stop data logging, press the “Start/Stop Logging” button. The “Measuring” indicator blinks 3 times to indicate the end of data logging.
4. To download the logged data to the Demo Software, connect the USB port ② to the computer using the supplied USB cable, and ensure that the power switch ③ on the board is in the USB position. The “USB” LED ④ will light.
5. In the software, select *Data Logging* from the *Tools* menu and click on the *Download Data* button ⑩ as shown in Figure 8. The maximum number of measurements that can be stored on the board is 2000.

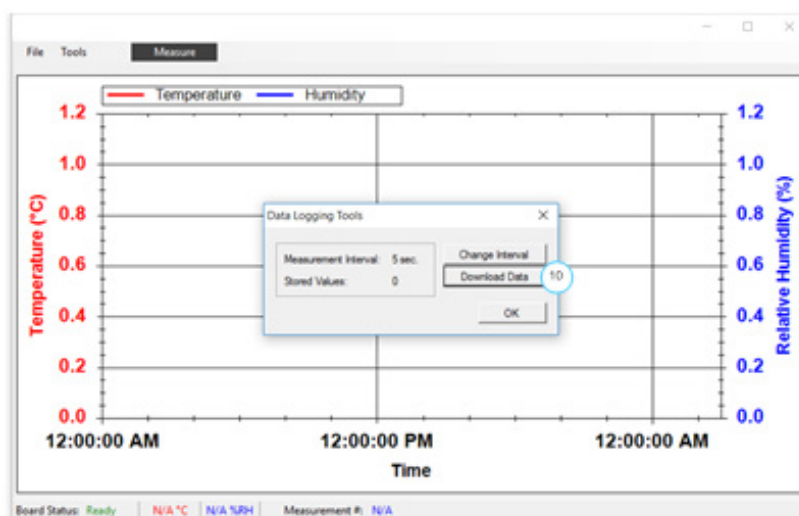



Figure 8. Download Data to Demo Software

2.4 Data Logging Settings

To change the data logging measurement interval, select *Data Logging* from the *Tools* menu, and then click on *Change Interval*. Enter the desired measurement interval, and click *OK*.

The data logging resolution can be selected in the same method as described in *Valid Settings Ranges*. Data logging settings can only be changed when no measurements are being taken.

2.5 Using the Plotter

The plotter  displays the measured relative humidity and temperature data simultaneously versus time (see Figure 3).

- Hold the left-mouse button, and drag it around an area to zoom onto that area.
- Hold the middle mouse or scroll button, and drag to pan across the plot area.
- To undo a zoom or pan operation, right click on the plot area, and select *Un-Zoom (Un-Pan)*.
- The plot area can always be reset to the default view by right clicking on the plot area and selecting *Undo All Zoom/Pan*.
- To display the measurement points on the plotted curves, right click on the plot area and select *Show Data Points*. While moving the application window, measurements points will not be plotted.

2.6 Valid Settings Ranges

Measurement settings can be selected within the following ranges:

- Measurement interval: 0.5 to 3600 s
- Number of measurements: 1 to unlimited
- Data logging interval: 1 to 250 s
- Measurement resolution: 8, 10, 12, 14 bits

3. Ordering Information

Part Number	Description
SDAH01	SDAH01 Evaluation Kit, including SDAH01 evaluation board, HS3001 sensor modules, sensor module extension cable, USB key with Demo Software, USB cable

4. Revision History

Revision	Date	Description
1.00	Aug 27, 2021	Initial release.