

Safety - when & where you need it most

SE4D Safety Light Curtains

Light curtains are used to keep production environments safe for both operators and maintenance workers by stopping machines when unsafe or dangerous areas have been accessed.

The IDEC SE4D Light Curtains are easy to install and use specialized technology to ensure there are no dead zones around the units. Their features increase safety, reduce downtime and improve productivity by allowing operations to continue without unnecessary interruptions.



Typical Applications:

- Automated manufacturing
- Packaging, material handling & storage machines
- Textile, woodworking and ceramic
- Automatic and semi-automatic assembling lines
- Automatic warehouse & inventory systems

No Dead Zones for easy installation

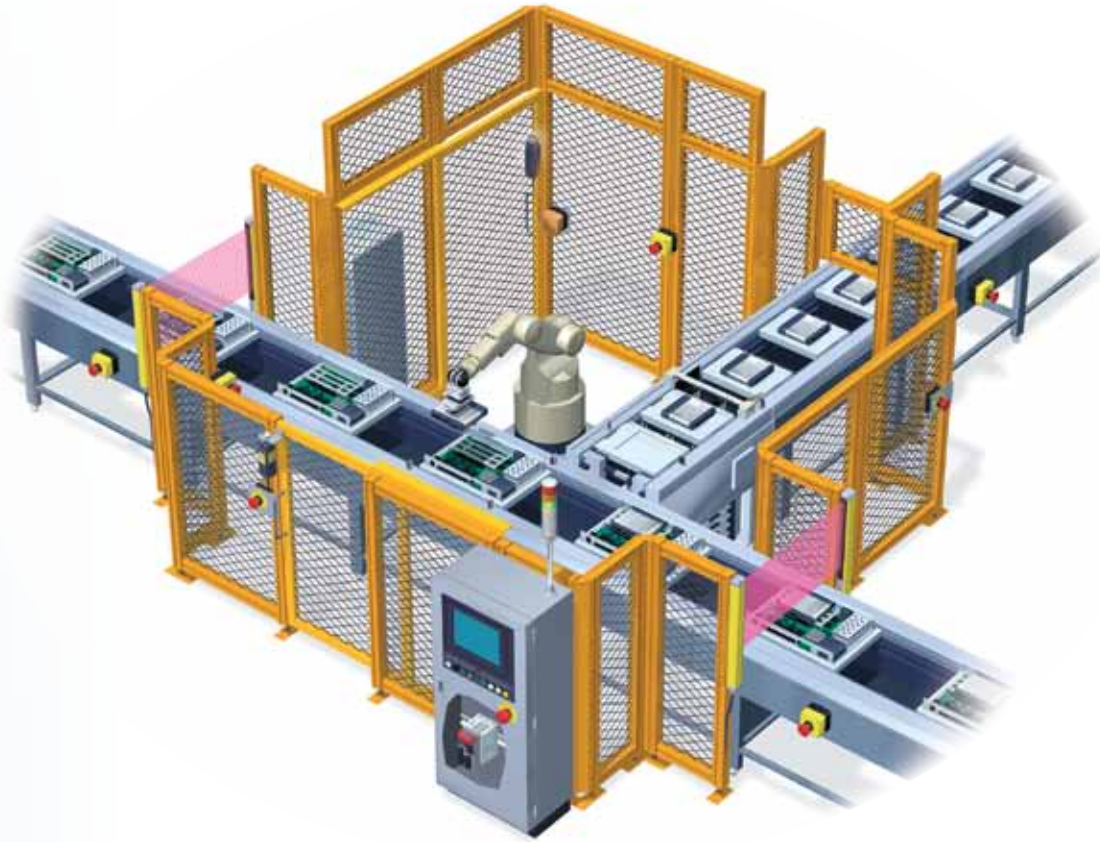

■ No Dead Zone

Conventional light curtains have a dead zone where there isn't any beam axis at the end of the units. With SE4D light curtains, the first beam axis is placed right along the edge, so detection can be performed along the entire length. Since it is not necessary to install it outside of the detection area in order to cover the dead zone, the SE4D light curtain can easily fit in any space.

SE4D Light Curtains

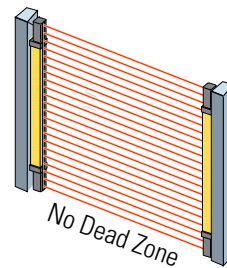

Conventional Light Curtains

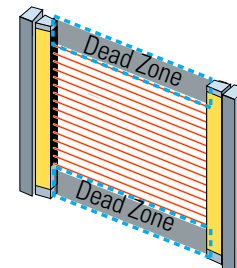

Conventional Light Curtains

Outside Mounting

Externally mounted light curtains can restrict access to equipment and machinery.

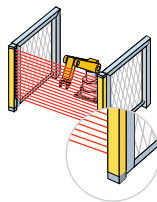

Inside Mounting

A customized barrier must be installed, at the bottom of the light curtain, to protect the dead zone.

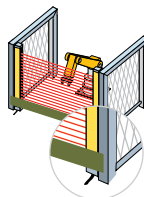

SE4D Light Curtains

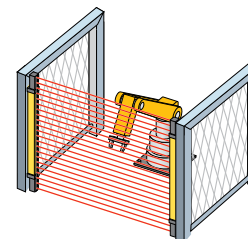

Because there are no dead zones with the SE4D Light Curtains, they fit easily into any application making them a safe and more flexible solution.

Easy to cascade & mute

■ Cascading with No Dead Zone

Series Connection
Up to 3 units - 192 beams

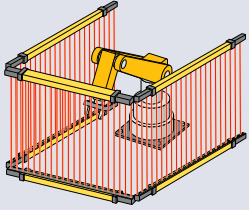

To cover "L" or "U" shaped configurations or to guard both the front and back of a machine, up to 3 light curtain sets (emitter and receiver) can be connected together in a series without any dead zones.

Conventional Method

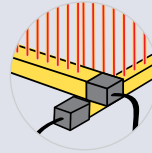

Units must overlap and can cause additional obstructions or unsafe areas.

SE4D Light Curtains

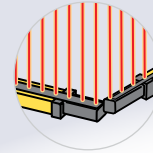

No dead zones!

■ Muting without Dedicated Controller

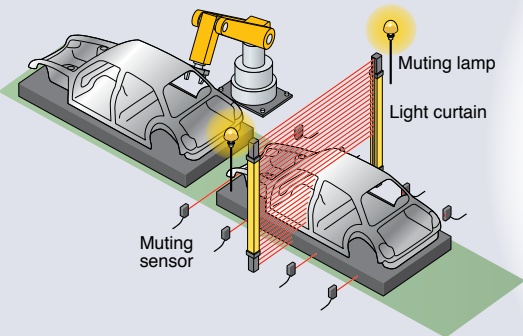

The SE4D light curtain is equipped with a muting function that causes production to stop when a person passes through the light curtain, but does not stop when an object passes through.

The advantage of the SE4D is that a muting sensor and muting lamp can be directly connected to the light curtain. A special controller for muting is not required.



Conventional Method



SE4D Light Curtains

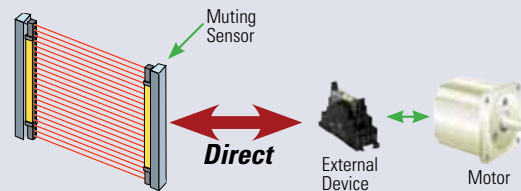

Because a special controller is not needed with the SE4D Light Curtains, a muting sensor and lamp can be directly connected reducing costs and saving installation time.

■ **Override**

When a light curtain is interrupted by an object or when operations stop before muting conditions are established (when only one muting sensor is interrupted), the object interrupting the light does not have to be removed. Therefore, operations can easily and safely resume.

Override Function

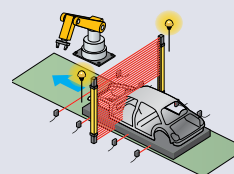

No need to remove object for restart.

No Override Function

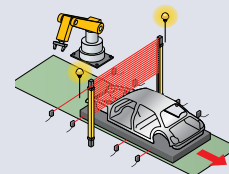

Object must be removed for restart.

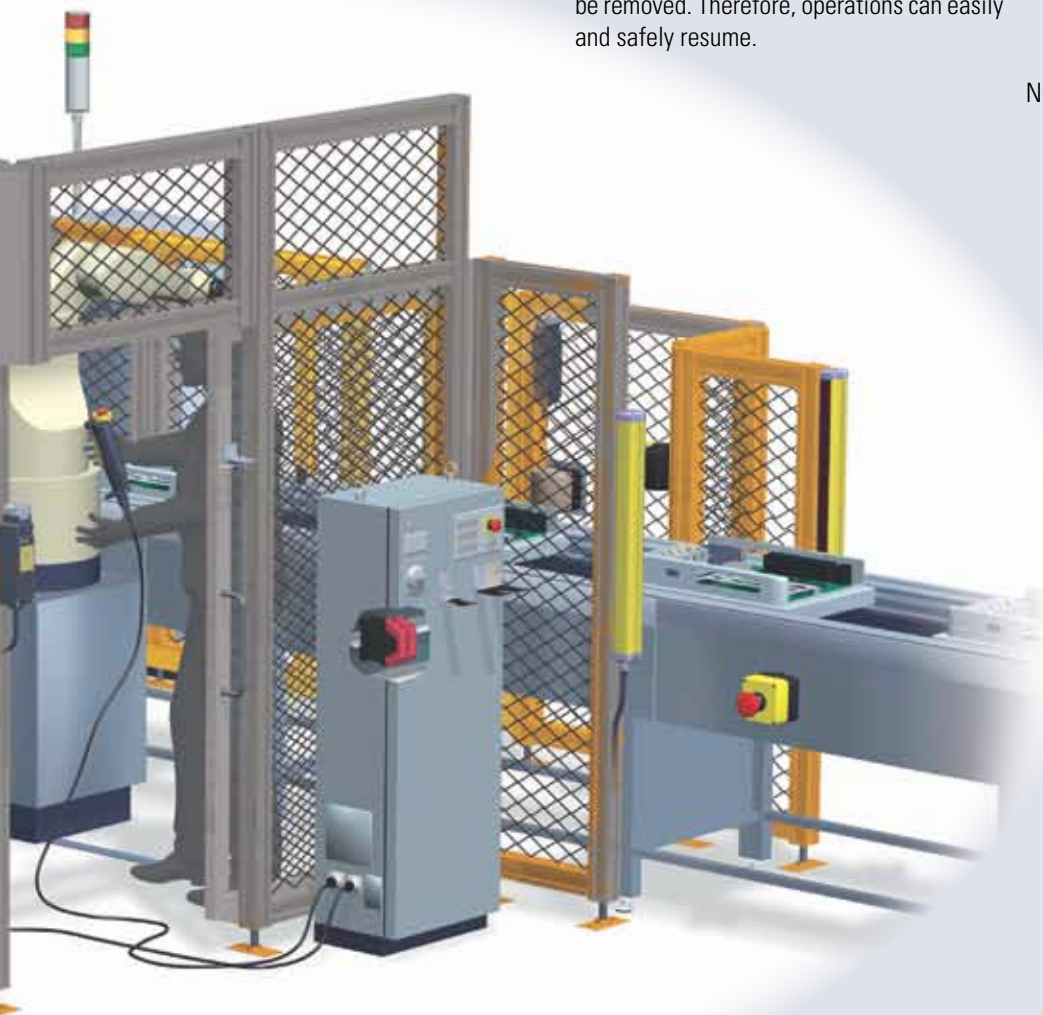

■ **Fixed and Floating Blanking***

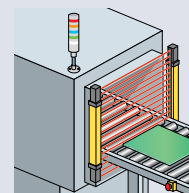

Fixed Blanking

Fixed blanking prevents the control output (OSSD1/2) from turning off when a specific beam is interrupted.

This is used in applications where a specific beam is always interrupted. When the object is moved outside of the sensing area, the control output (OSSD1/2) turns off.

Floating Blanking

Floating blanking function prevents the control output (OSSD1/2) from turning off when the number of beams interrupted is less than a preset number. The number that can be set is from 1 to 3 beams. This function enables sensing even when the position of the obstacles changes in the sensing area.

Note: The size of the minimum sensing object can change when the floating blanking function is used.

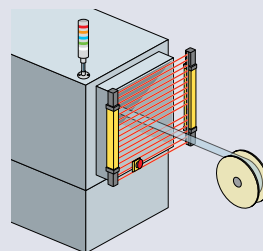

800.262.4332

www.IDEC.com/safety

*A controller (SE9Z-HC) is required for setting blanking functions.

Fast operation & simple setup

■ Built-in EDM (External Device Monitoring)

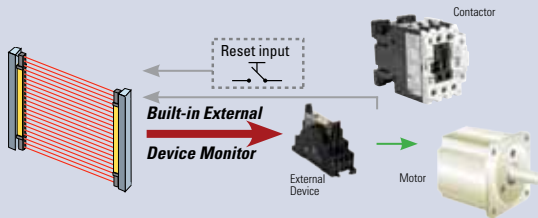

Since the SE4D light curtains have built-in EDM (external device monitoring), a safety circuit can easily be constructed without a safety relay module. As a result, the control panel can be downsized and costs reduced.

■ Fast Unified Response Time of 14ms

Series Connection - up to 3 units or 192 beams

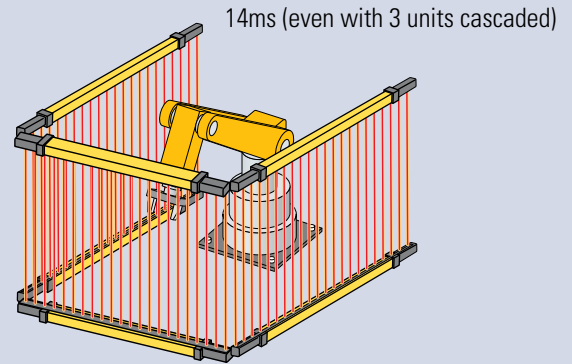

Regardless of the number of beams or the number of light curtains connected in a series, the maximum response time is 14ms! This reduces the time needed to calculate safety distances.

■ Beam Axis Adjustment

Light beams are divided into 4 blocks.

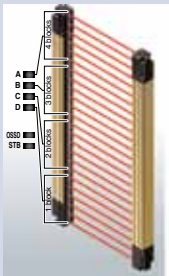

| Step 1 | Step 2 | Step 3 |
|-----------------------------|----------------------------------|-----------------------|
| LED "D" flashes red | LEDs "C" and "D" are red | All LEDs are green |
| | | |
| Align the lowest beam axis. | Only the bottom two LEDs are on. | Beam axis is aligned. |

Beam-axis alignment indicators display the light curtain's beam channels in four blocks. When the beam channel at the bottom channel (or top channel) is correctly aligned, the LED will blink red. Each block then lights red as the beam axes become aligned. When all channel beam axes are aligned, all LEDs will be green. The display also has a stability indicator (STB) to assist with setup.



Both PNP & NPN Supported in One Model

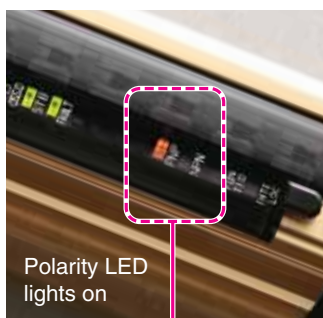

Polarity LED lights on

PNP/NPN polarity LED

Both PNP and NPN transistor outputs are available in one light curtain.

Switch Between PNP/NPN by Changing Wiring

When the output polarity setting wire (shield) is connected to 0V the output is PNP. It becomes NPN when connected to 24V.

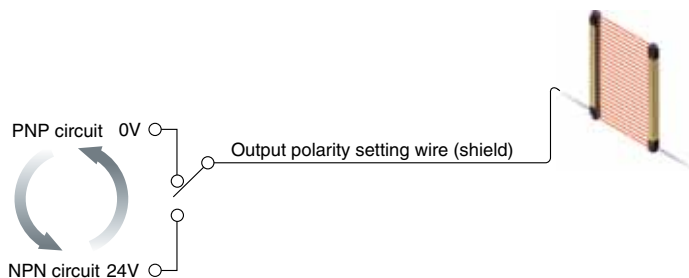

| Output Polarity Setting Wire (shield) | Control Output (OSSD) |
|---------------------------------------|-----------------------|
| Connect to 0V | PNP output |
| Connect to 24V | NPN output |
| Not connected/open | Error |

800.262.4332

www.IDEC.com/safety



Part Numbers

SE4D Light Curtains

| Shape | Minimum Sensing Object | Sensing Distance (Note 2) (Effective Distance) | No. of Beams | Sensing Length (mm) | Part Number (Note 3) |
|-------|------------------------|--|--------------|---------------------|----------------------|
| | | 0.3 to 9m | 12 | 230 | SE4D-H12 |
| | | | 16 | 310 | SE4D-H16 |
| | | | 20 | 390 | SE4D-H20 |
| | | | 24 | 470 | SE4D-H24 |
| | | | 28 | 550 | SE4D-H28 |
| | | | 32 | 630 | SE4D-H32 |
| | | | 36 | 710 | SE4D-H36 |
| | | | 40 | 790 | SE4D-H40 |
| | | | 48 | 950 | SE4D-H48 |
| | | | 56 | 1,110 | SE4D-H56 |
| | | | 64 | 1,270 | SE4D-H64 |
| | | | 72 | 1,430 | SE4D-H72 |
| | | | 80 | 1,590 | SE4D-H80 |
| | | | 88 | 1,750 | SE4D-H88 |
| | | | 96 | 1,910 | SE4D-H96 |

- Package quantity is 1 set (emitter/receiver). Mounting brackets and bottom cap cables are not included with the light curtain. Purchase a mounting bracket and bottom cap cable separately.
- The sensing distance is the possible setting distance between the emitter and the receiver.
- The light curtain with "E" in the part number (indicated on the nameplate) is the emitter. The light curtain with "D" in the part number (indicated on the nameplate) is the receiver.
Example for SE4D-H12: Emitter = SE4D-H12E, Receiver = SE4D-H12D

Accessories

| Item | Description | Cable Length | Weight | Part Number | Remarks |
|------|-----------------------------|--------------|----------------|--------------|---|
| | 8-pin Bottom Cap Cable | 3m | 370g approx. | SE9Z-CCB3 | Standard cable Cable diameter: ø6mm Cable color: Emitter - Gray, Receiver - Gray with black line Minimum bending diameter: R6 mm |
| | | 7m | 820g approx. | SE9Z-CCB7 | |
| | | 10m | 1,160g approx. | SE9Z-CCB10 | |
| | | 15m | 1,710g approx. | SE9Z-CCB15 | |
| | 12-pin Bottom Cap Cable | 3m | 420g approx. | SE9Z-CCB3-MU | Used for muting function Cable diameter: ø6mm Cable color: Emitter - Gray, Receiver - Gray with black line Minimum bending diameter: R6 mm |
| | | 7m | 930g approx. | SE9Z-CCB7-MU | |
| | Cable for Series Connection | 0.5m | 95g approx. | SE9Z-CSL05 | Used for connecting the light curtains in series. Cable color: Gray (for emitter and receiver) Minimum bending diameter: R6 mm |

Each pkg contains 2 cables.

Controller

| Name and Shape | Part Number |
|---|-------------|
| Controller (adapter cable, 2 pcs, included) | SE9Z-HC |
| Cable for Connecting Controller | SE9Z-WNC1 |

The controller is used for setting optional functions.
The cable is used for connecting the controller and the light curtain. Order the cable when purchasing the controller.

Mounting Brackets

| Item | Part Number | Remarks |
|-----------------------------|--------------|--|
| Standard Mounting Bracket | SE9Z-SED-1 | Mounting bracket for easy adjustment of the beam axis. Includes 2 hexagon socket head screws (M5) or 1 hexagon socket head screw (M8). The light curtain can be rotated 360 degrees. Material: Zinc diecast |
| M8 Mounting Bracket | SE9Z-SED-1-T | Mounting bracket for easy adjustment of the beam axis. The light curtain can be rotated 360 degrees. Material: Zinc diecast |
| Dead Space Mounting Bracket | SE9Z-SED-3 | Mounting bracket that eliminates dead space. Material: Zinc diecast |

Package Qty: 4

800.262.4332

www.IDEC.com/safety

General Specifications

| | | | |
|--------------------------------------|--|---|--|
| Applicable standards | IEC/EN 61496-1 (TÜV), IEC 61496-2 (TÜV), IEC 61508-1 to 4 (TÜV), ISO 13849-1 (TÜV), EN ISO 13849-1 (TÜV), EN 50178 (TÜV), EN 55011 (TÜV), EN 61000-6-2 (TÜV), UL 508 (UL), UL 61496-1/2 (UL), UL 1998 (UL), CSA C22.2 No.14 (c-UL), CSA C22.2 No.0.8 (c-UL) | | |
| Minimum Sensing Object | ø25mm (opaque) | | |
| Effective Aperture Angle | When detection distance is more than 3m: within ±2.5° maximum (IEC 61496-2, UL 61496-2) | | |
| Rated Voltage | 24V DC ±20% Ripple P-P10% maximum | | |
| Control output (OSSD1/2) | PNP open-collector transistor / NPN open-collector transistor (switching type) | | |
| | PNP Output Maximum source current: 200mA Applied voltage: Same as supply voltage (between control output and +V) Residual voltage: 2.5V max. (source current 200mA, using 15m length cable) Leakage current: 0.1mA max. (includes power off state) Maximum load capacity: 0.22µF (no load to max. output current) Load wiring resistance: 3W max. | NPN Output Maximum sink current: 200mA Applied voltage: Same as supply voltage (between control output and 0V) Residual voltage: 2.5V max. (sink current 200 mA, using 15m length cable) Leakage current: 0.1mA max. (includes power off state) Maximum load capacity: 0.22µF (no load to max. output current) Load wiring resistance: 3W max. | |
| Operation mode (Output operation) | ON when all beams are received, OFF when one or more beams are interrupted (Note 1, 2) (Also turns OFF at sensor or synchronization error) | | |
| Protection circuit (Short-circuit) | Built-in | | |
| Response Time | OFF response: 14ms max., ON response: 80 to 90ms | | |
| Auxiliary output (Non-safety output) | PNP open-collector transistor / NPN open-collector transistor (switching type) | | |
| | PNP Output Maximum source current: 60mA Applied voltage: Same as supply voltage (between auxiliary output and +V) Residual voltage: 2.5V min. (source current 60mA, using 15m length cable) | NPN Output Maximum sink current: 60mA Applied voltage: Same as supply voltage (between auxiliary output and 0V) Residual voltage: 2.5V min. (sink current 60mA, using 15m length cable) | |
| Operation mode (Output operation) | When OSSDs are ON: OFF, when OSSDs are OFF: ON (factory set) [Operation modes can be changed by using the SE9Z-HC controller (optional).] | | |
| Protection circuit (Short-circuit) | Built-in | | |
| Response Time | OFF response: 34ms max., ON response: 110ms max. | | |
| Interference Prevention Function | Built-in | | |
| Emission Halt Function | | | |
| Interlock Function | | | |
| External Device Monitoring Function | | | |
| Override Function | | | |
| Muting Function | | | |
| Optional Functions (Note 4) | Fixed blanking function, Floating blanking function, Auxiliary output switching function, Interlock setting adjust function, External relay monitoring setting adjust function, Muting setting adjust function, Protect function, Emitted light intensity control function | | |
| Degree of Protection | IP65, IP67 (IEC 60529) | | |
| Operating Conditions | Operating temperature: -10 to +55°C (no freezing) Relative humidity: 30 to 85%RH (no condensation) Storage temperature: -25 to +70°C (no freezing) Storage humidity: 30 to 95%RH (no condensation) Pollution Degree: 3 | | |
| Operating Illuminance | Incandescent lamp: 3,500 lux max. at light-receiving surface | | |
| Dielectric Strength | 1,000V AC, 1 minute between power terminals connected together and enclosure | | |
| Insulation Resistance | 20MW minimum (500V DC megger) between power terminals connected together and enclosure | | |
| Vibration Resistance | Damage limits: 10 to 55Hz, amplitude: 0.75mm 2 hours each in 3 axes | | |
| Shock Resistance | Damage limits: 300m/s ² (30G approx.) 3 times each in 3 axes | | |
| Light Source | Infrared LED (emission wavelength = 870nm) | | |
| Connection | Connector | | |
| Material | Enclosure: Aluminum Upper / lower case: Aluminum Sensing surface: PC / Polyester resin Cap: PBT | | |
| Accessories | SE9Z-SED-2 (intermediate supporting bracket) (Note 3), SE9Z-TR25 (test rod): 1 | | |

- Does not turn OFF during muting even when the light beam is interrupted.
- When the blanking function is enabled, the operation mode changes:

| Floating Blanking Function (Min. Sensing Object) | | | |
|---|---------|--------|--------|
| No setting | Setting | | |
| | 1 beam | 2 beam | 3 beam |
| ø25mm | ø45mm | ø65mm | ø85mm |

- The number of intermediate supporting brackets that is included differs with each model.
SE4D-H40/H48/H56 = 1 set, SE4D-H64/H72/H80 = 2 sets, SE4D-H88/H96 = 3 sets
- When using the optional functions, the controller is required.

Individual Specifications

| Part Number | SE4D-H12 | SE4D-H16 | SE4D-H20 | SE4D-H24 | SE4D-H28 | SE4D-H32 |
|---------------------|---|-----------------------|-----------------------|--|-----------------------|-----------------------|
| No. of Beams | 12 | 16 | 20 | 24 | 28 | 32 |
| Sensing Range | 0.3 to 9m | | | | | |
| Beam Width | 20mm | | | | | |
| Protective Height | 230mm | 310mm | 390mm | 470mm | 550mm | 630mm |
| Current Consumption | Emitter: 70mA max., Receiver: 95mA max. | | | Emitter: 80mA max., Receiver: 115mA max. | | |
| PFHd | 2.01×10 ⁻⁹ | 2.21×10 ⁻⁹ | 2.41×10 ⁻⁹ | 2.61×10 ⁻⁹ | 2.81×10 ⁻⁹ | 3.01×10 ⁻⁹ |
| MTTFd | 100 years minimum | | | | | |
| Weight (approx.) | 510g | 660g | 810g | 960g | 1,110g | 1,260g |

| Part Number | SE4D-H36 | SE4D-H40 | SE4D-H48 | SE4D-H56 | SE4D-H64 | SE4D-H72 |
|---------------------|--|--|-----------------------|---|-----------------------|---|
| No. of Beams | 36 | 40 | 48 | 56 | 64 | 72 |
| Sensing Range | 0.3 to 9m | | | | | 0.3 to 7m |
| Beam Width | 20mm | | | | | |
| Protective Height | 710mm | 790mm | 950mm | 1,110mm | 1,270mm | 1,430mm |
| Current Consumption | Emitter: 80mA max. Receiver: 115mA max. | Emitter: 90mA max. Receiver: 140mA max. | | Emitter: 100mA max. Receiver: 160mA max. | | Emitter: 110mA max. Receiver: 180mA max. |
| PFHd | 3.21×10 ⁻⁹ | 3.41×10 ⁻⁹ | 3.80×10 ⁻⁹ | 4.20×10 ⁻⁹ | 4.60×10 ⁻⁹ | 5.00×10 ⁻⁹ |
| MTTFd | 100 years minimum | | | | | |
| Weight (approx.) | 1,420g | 1,570g | 1,870g | 2,170g | 2,470g | 2,770g |

| Part Number | SE4D-H80 | SE4D-H88 | SE4D-H96 |
|---------------------|---|---|-----------------------|
| No. of Beams | 80 | 88 | 96 |
| Sensing Range | 0.3 to 7m | | |
| Beam Width | 20mm | | |
| Protective Height | 1,590mm | 1,750mm | 1,910mm |
| Current Consumption | Emitter: 110mA max. Receiver: 180mA max. | Emitter: 120mA max. Receiver: 200mA max. | |
| PFHd | 5.40×10 ⁻⁹ | 5.80×10 ⁻⁹ | 6.20×10 ⁻⁹ |
| MTTFd | 100 years minimum | | |
| Weight (approx.) | 3,070g | 3,370g | 3,670g |

Note: PFHd (Probability of dangerous failure per hour), MTTFd (Mean time to dangerous failure)
Weight is the (total of emitter and receiver).

Controller

| | |
|-----------------------|---|
| Part Number | SE9Z-HC |
| Supply Voltage | 24V DC ±10% Ripple P-P10 % or less (common to light curtain power supply) |
| Current Consumption | 65mA max. |
| Communication Method | RS-485 two-way communications (exclusive procedure) |
| Digital LED | 4-digit red LED display × 2 (selected beams and settings are displayed) |
| Functional LED | Green LED × 9 (lights on when set) |
| Functions | <ul style="list-style-type: none"> Fixed blanking function (factory setting: disabled) Floating blanking function (factory setting: disabled) Auxiliary output switching function (factory setting: negative logic of OSSD) Emitted light intensity control function (factory setting: disabled) Muting setting adjust function (factory setting: all beam channels enabled, A = B (Note 2), Muting lamp diagnosis function enabled, Muting sensor output operation N.O/N.O) Interlock setting adjust function (factory setting: start /restart) External device monitoring setting adjust function (factory setting: enabled, 300ms) Override setting adjust function, Setting detail monitoring function Protect function (factory setting: disabled) (factory password setting: 0000) Initialization function Copy function |
| Operating Conditions | Operating Temperature: -10 to +55°C (no freezing) Operating Humidity: 30 to 85% RH (no condensation) Storage Temperature: -25 to +70°C (no freezing) Storage Humidity: 30 to 85% RH (no condensation) |
| Dielectric Strength | 1,000V AC, 1 minute between power terminals connected together and enclosure |
| Insulation Resistance | 20MΩ min. (500V DC megger) between power terminals connected together and enclosure |
| Cable | 8-core shielded cable, 0.5m 1.640 ft long, with a connector at the end (2 cables) |
| Weight (approx.) | 200g |
| Accessories | Adapter cable: 2 |

1. The operating humidity is +20° for conditions that are not specified.

2. To enable the muting function, A or B input order can be specified. The muting function is enabled, at the factory, whether muting A or B is input first.

