

SF2137E

**869.00 MHz
SAW Filter**

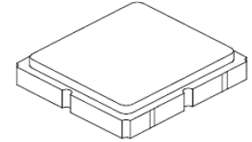

SM3030-6

- *Steep Roll-off Filter for 869.00 MHz Unlicensed Band*
- *Complies with Directive 2002/95/EC (RoHS)*
- *No Matching Required for Operation in 50Ω Environment*
- *Moisture Sensitivity Level: 1*

Absolute Maximum Ratings

Rating	Value	Units
Input Power Level	17	dBm
DC Voltage on any Non-ground Terminal	3	V
Operating Temperature Range	-40 to +85	°C
Storage Temperature Range in Tape and Reel	-40 to +85	°C
Maximum Soldering Profile, 5 Cycles/10 seconds Maximum	265	°C

Electrical Characteristics

Characteristic	Sym	Notes	Min	Typ	Max	Units
Center Frequency	f_c			869.00		MHz
Bandwidth, 1 dB				11		
Bandwidth, 3 dB				17		
Insertion Loss, 868 to 870 MHz	IL			2.8	4.0	dB
Amplitude Ripple, 868 to 870 MHz				0.2	1.5	dB _{P-P}
Attenuation Referenced to 0 dB:						dB
825 to 828 MHz			40	47		
835 to 842 MHz			30	39		
891 to 894 MHz			30	42		
910 to 913 MHz			40	47		
Source Impedance	Z_s			50		Ω
Load Impedance	Z_L			50		Ω

Case Style	SM3030-6 3.0 x 3.0 mm Nominal Footprint
Lid Symbolization, Y=year, WW=week, S=shift, Dot=pin 1 indicator	711, <u>YWWS</u>

Electrical Connections

Connection	Terminals
Port 1	2
Port 2	5
Case Ground	All others

 **CAUTION: Electrostatic Sensitive Device. Observe precautions for handling.**
NOTES:

1. The design, manufacturing process, and specifications of this device are subject to change.
2. US or International patents may apply.
3. RoHS compliant from the first date of manufacture.

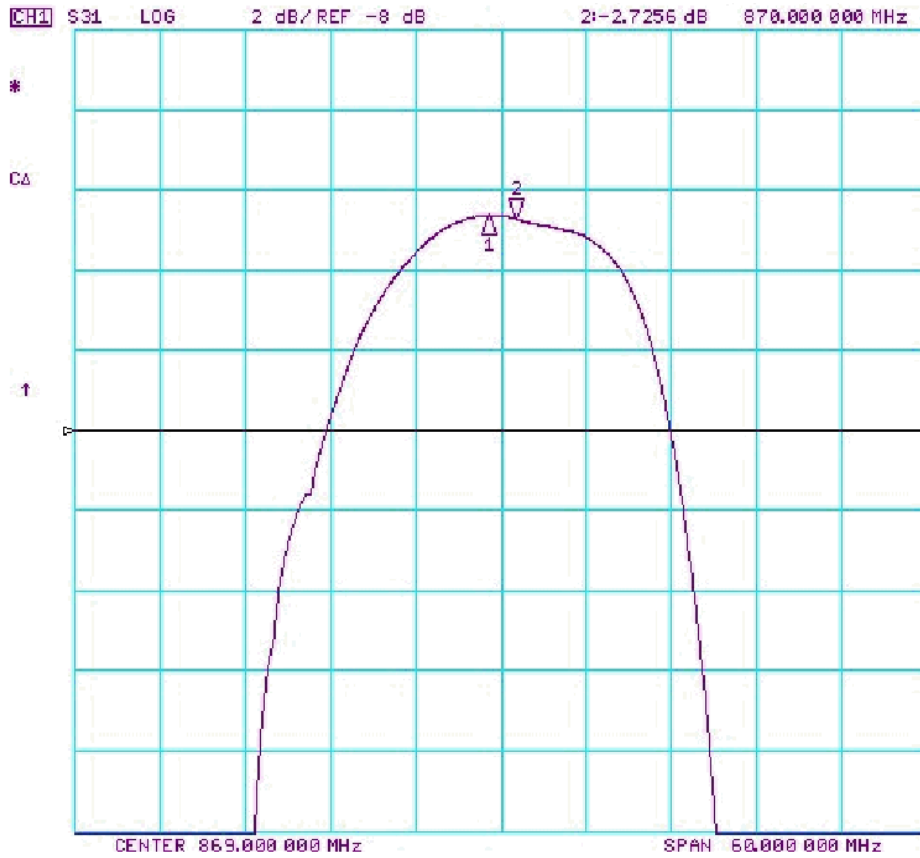

CH1 Markers
 1i-2.6412 dB
 868.000 MHz

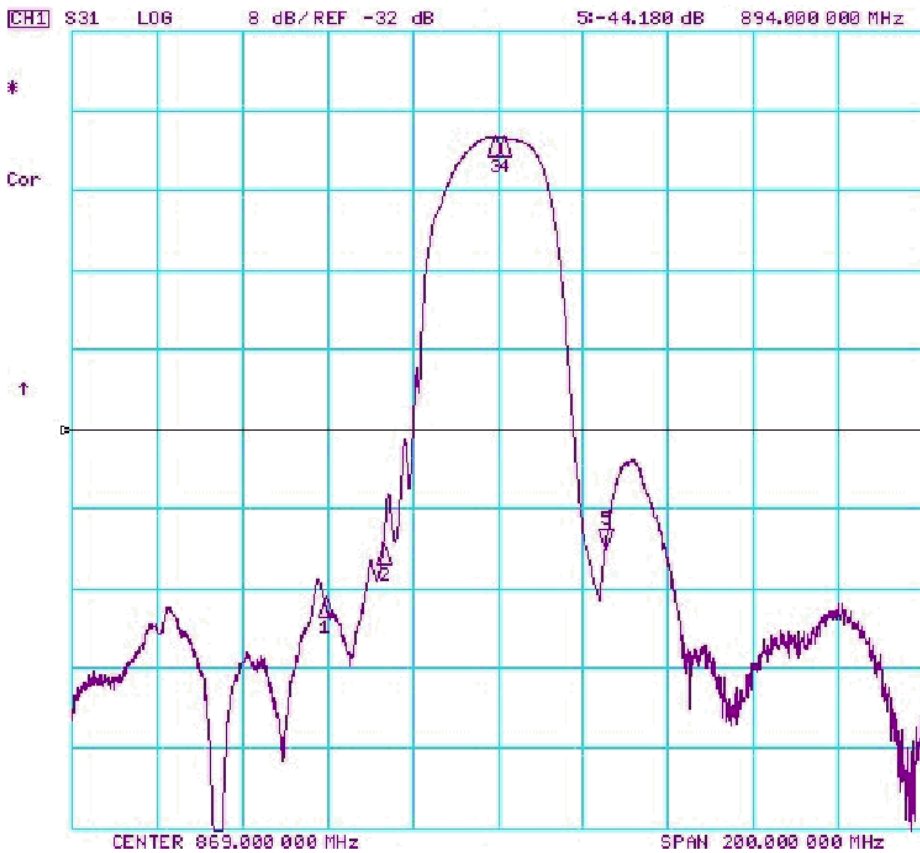

CH1 Markers
 1i-43.024 dB
 828.000 MHz
 2i-43.517 dB
 842.000 MHz
 3i-2.6378 dB
 868.000 MHz
 4i-2.7213 dB
 870.000 MHz

CH1 S31 LOG 10 dB/REF -40 dB 41-47.219 dB 910.000 000 MHz

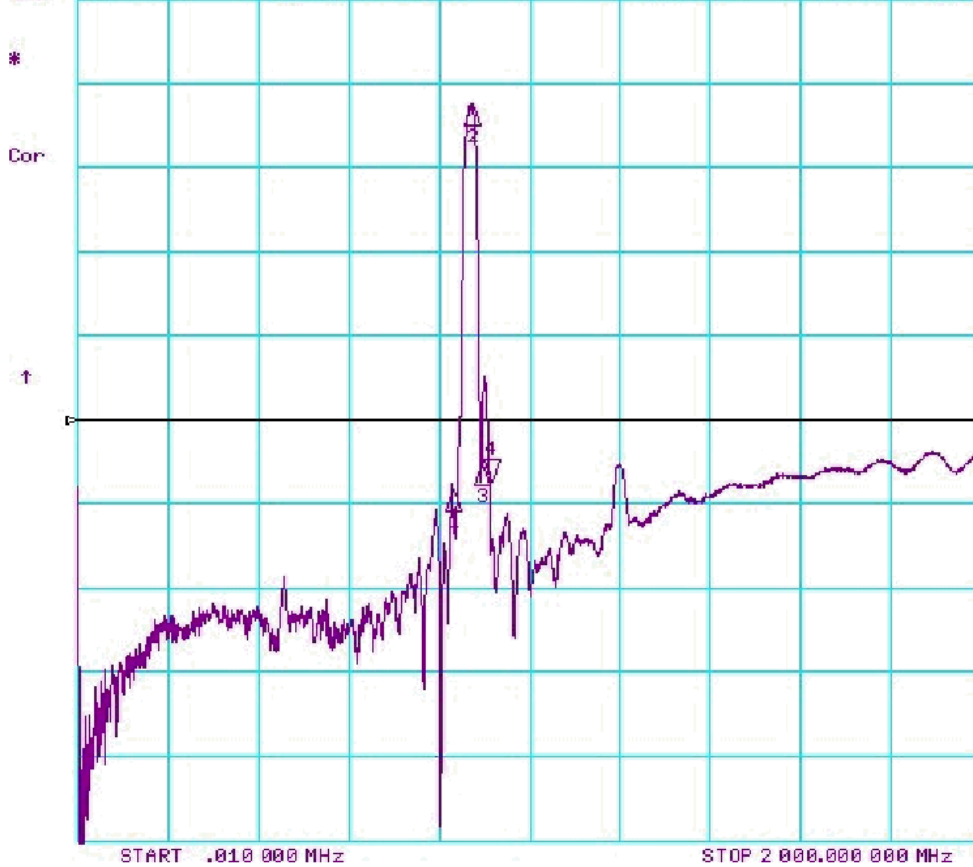

CH1 Markers
1:-48.523 dB
820.000 MHz
2:-2.5911 dB
869.000 MHz
3:-45.496 dB
891.000 MHz

SM3030-6 Case

6-Terminal Ceramic Surface-Mount Case 3.0 X 3.0 mm Nominal Footprint

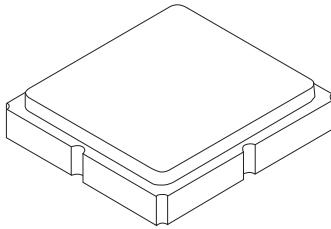

PCB Footprint Top View

Case and PCB Footprint Dimensions

Dimension	mm			Inches		
	Min	Nom	Max	Min	Nom	Max
A	2.87	3.00	3.13	0.113	0.118	0.123
B	2.87	3.00	3.13	0.113	0.118	0.123
C	1.12	1.25	1.38	0.044	0.049	0.054
D	0.77	0.90	1.03	0.030	0.035	0.040
E	2.67	2.80	2.93	0.105	0.110	0.115
F	1.47	1.60	1.73	0.058	0.063	0.068
G	0.72	0.85	0.98	0.028	0.033	0.038
H	1.37	1.50	1.63	0.054	0.059	0.064
I	0.47	0.60	0.73	0.019	0.024	0.029
J	1.17	1.30	1.43	0.046	0.051	0.056
K		3.20			0.126	
L		1.70			0.067	
M		1.05			0.041	
N		0.81			0.032	
O		0.38			0.015	

Case Materials

Materials	
Solder Pad Plating	0.3 to 1.0 μm Gold over 1.27 to 8.89 μm Nickel
Lid Plating	2.0 to 3.0 μm Nickel
Body	Al_2O_3 Ceramic

Top View

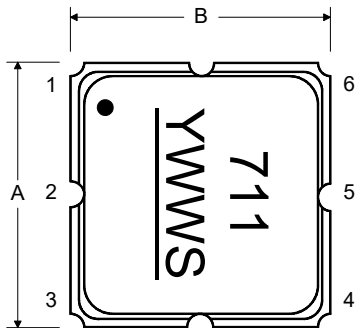

Bottom View

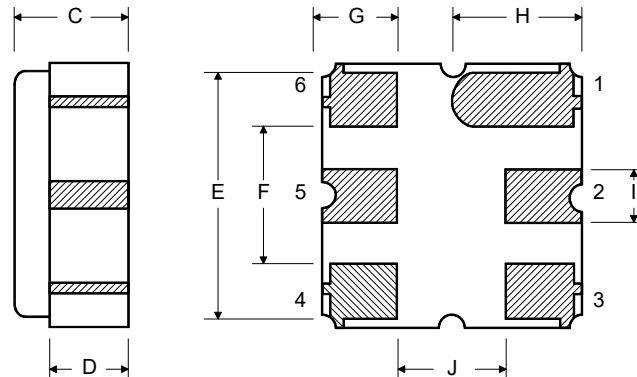

Tape and Reel Specifications

Tape and Reel Standard per ANSI/EIA-481

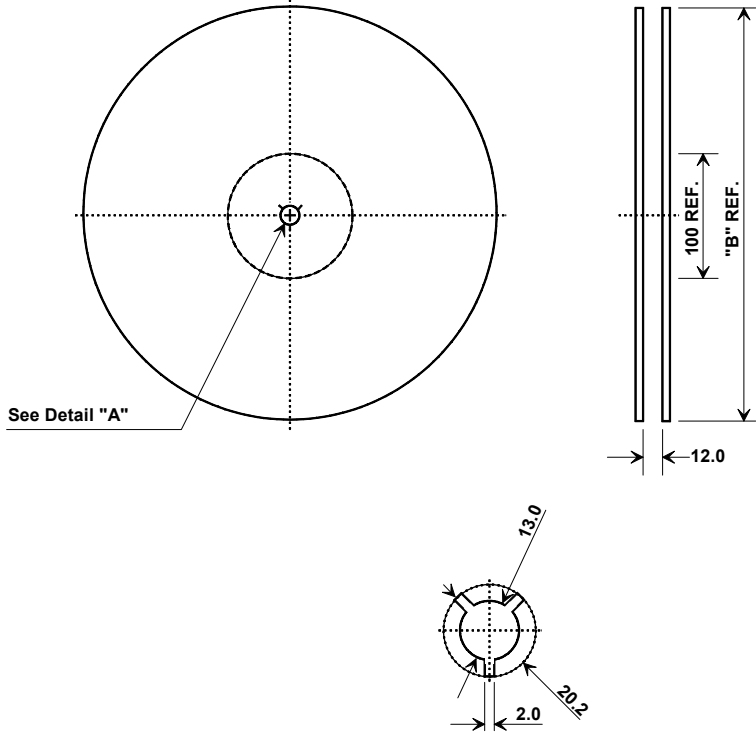

"B"		Quantity Per Reel
Inches	millimeters	
7	178	500
13	330	3000

COMPONENT ORIENTATION and DIMENSIONS

Carrier Tape Dimensions	
Ao	3.35 mm
Bo	3.35 mm
Ko	1.40 mm
Pitch	8.0 mm
W	12.0 mm

