

SF2140A-1

**140.0 MHz
SAW Filter**

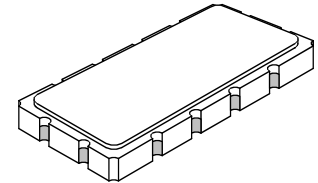

SMP-53

- **Excellent Size-to-Performance Ratio**
- **Hermetic 13.3 X 6.5 mm Surface-Mount Case**
- **Complies with Directive 2002/95/EC (RoHS)**
- **Moisture Sensitivity Level: 1**

Absolute Maximum Ratings

Rating	Value	Units
Input Power Level	+10	dBm
Storage Temperature Range	-40 to +85	°C
Operating Temperature Range	-30 to +80	°C
Suitable for Lead-free Soldering - Maximum Soldering Profile	260 °C for 30 s	

Electrical Characteristics

Characteristic	Sym	Notes	Min	Typ	Max	Units
Nominal Center Frequency	f_C			140.0		MHz
Maximum Insertion Loss at f_C	IL			10.3	11.0	dB
1 dB Bandwidth			18.4	20.8		MHz
3 dB Bandwidth			19.6	21.4		MHz
35 dB Bandwidth				25.2	26.4	MHz
Passband Ripple, 130.8 to 149.2 MHz				0.8	1.0	dB
Group Delay Ripple, 130.8 to 149.2 MHz				115	160	ns
Absolute Group Delay				1.0		µs
Input VSWR, 130.8 to 149.2 MHz				1.7	2.8	dB
Output VSWR, 130.8 to 149.2 MHz				1.8	2.3	dB
Temperature Coefficient						ppm/°C
Attenuation Referenced to Insertion Loss at f_C						
10 to 90 MHz			35	49		dB
90 to 120 MHz			40	47		
120 to 126.8 MHz			35	50		
153.2 to 160 MHz			35	45		
160 to 190 MHz			40	53		
190 to 800 MHz			35	62		
Source/Load Impedance				50		ohms

Case Style	SMP-53 13.3 X 6.5 mm Nominal Footprint
Lid Symbolization (YY=year, WW=week, S = Shift, ## = Sequence Code)	RFM, SF2140A-1, YYWWS##



CAUTION: Electrostatic Sensitive Device. Observe precautions for handling.

NOTES:

1. The design, manufacturing process, and specifications of this device are subject to change.
2. US or International patents may apply.
3. RoHS compliant from the first date of manufacture.

SF2140A-1 S₂₁ Amplitude Response

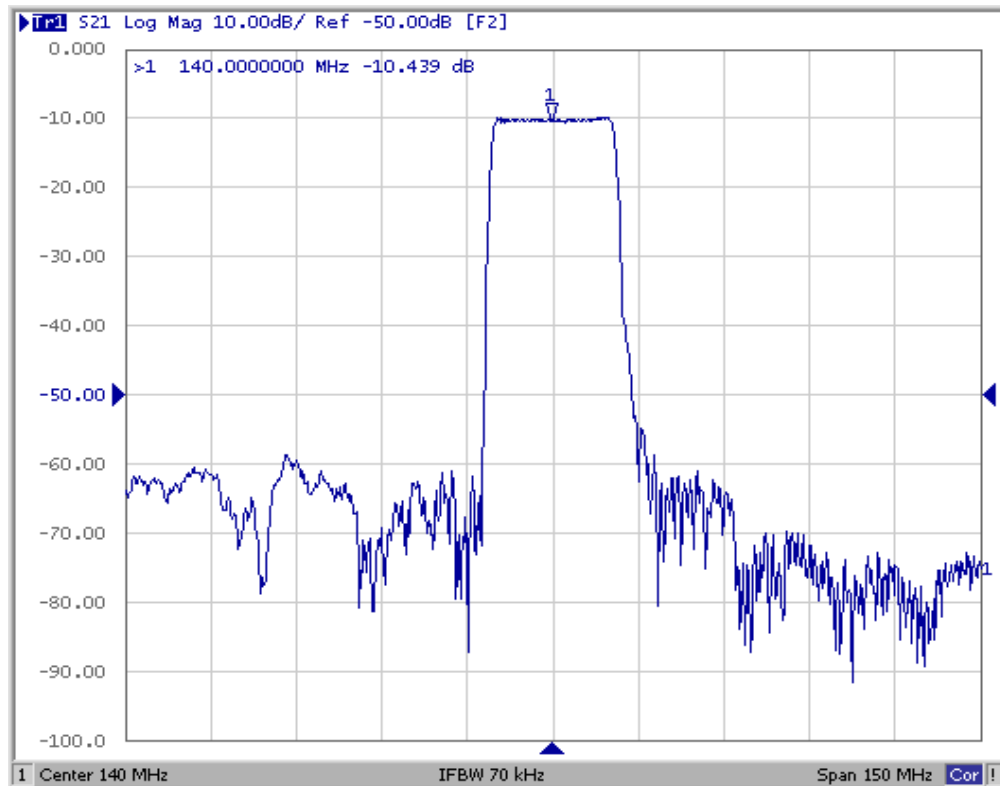

SF2140A-1 Pass-band Amplitude and Group Delay Ripple

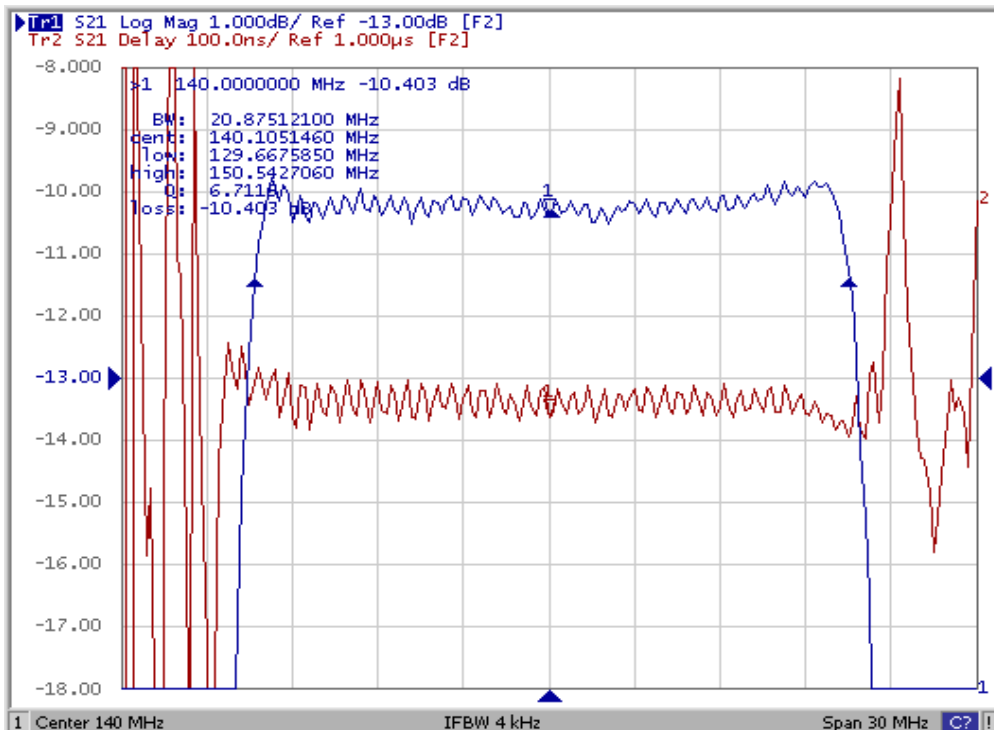

SF2140A-1 S_{11} Impedance Plot through Matching Network

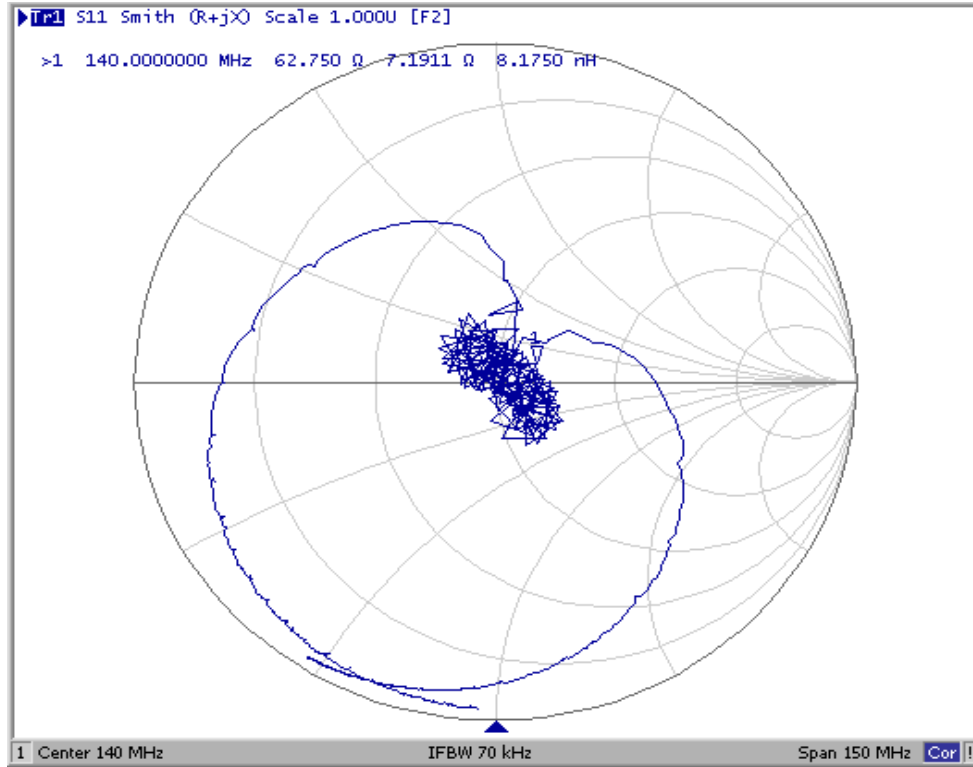

SF2140A-1 S_{22} Impedance Plot through Matching Network

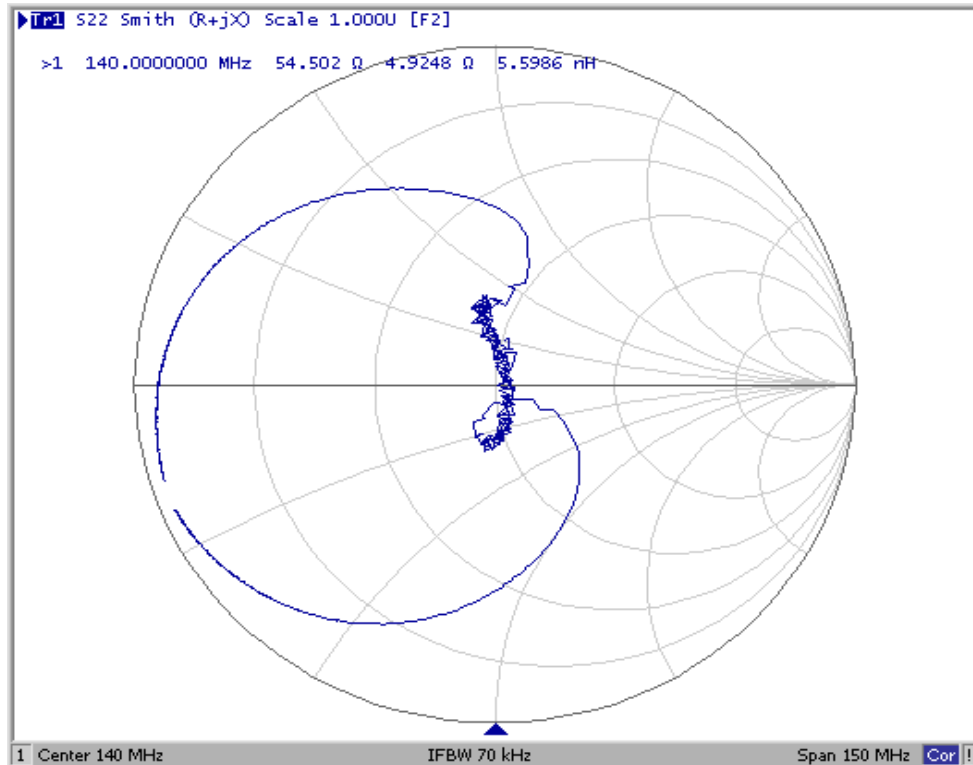

SF2140A-1 50 ohm Matching Network

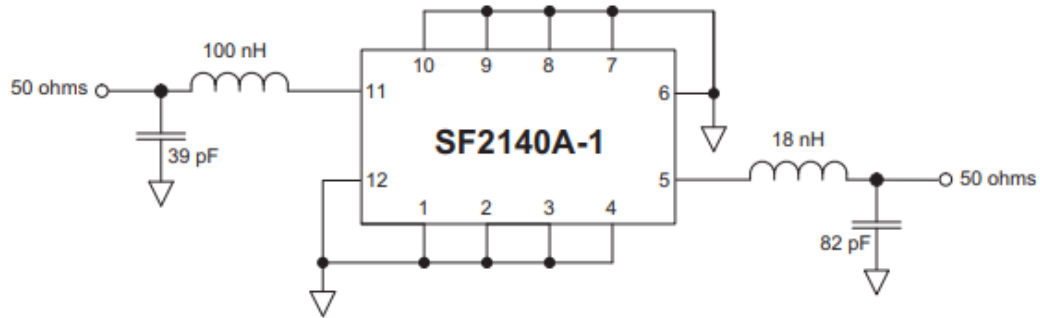

SF2140A-1 Circuit Board Pad Layout

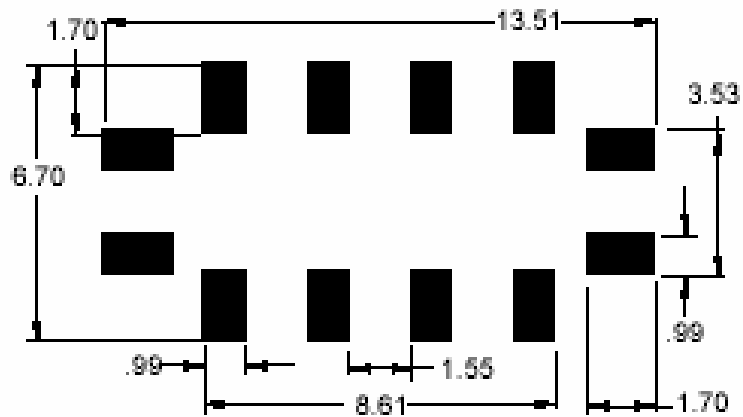

SMP-53 Case

12-Terminal Ceramic Surface-Mount Case 13.3 x 6.5 mm Nominal Footprint

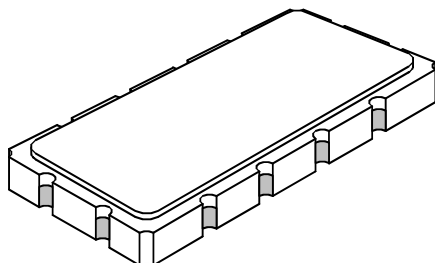

Case Dimensions						
Dimension	mm			Inches		
	Min	Nom	Max	Min	Nom	Max
A	13.08	13.31	13.60	0.515	0.524	0.535
B	6.27	6.50	6.80	0.247	0.256	0.268
C		1.91	2.00		0.075	0.079
D		1.50			0.059	
E		0.79			0.031	
H		1.0			0.039	
P		2.54			0.100	

Electrical Connections		
Connection		Terminals
Port 1	RF Input	11
	RF Input Ground	12
Port 2	RF Output	5
	RF Output Ground	6
Ground		All others

Materials	
Solder Pad Plating	0.3 to 1.0 μm Gold over 1.27 to 8.89 μm Nickel
Lid Plating	2.0 to 3.0 μm Nickel
Body	Al_2O_3 Ceramic

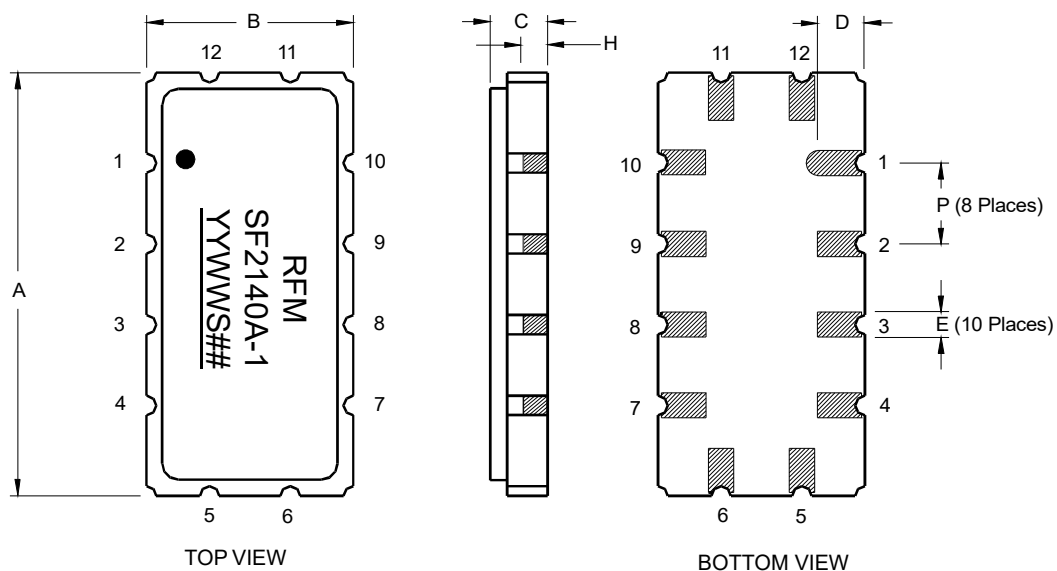

Tape and Reel Specifications

Tape and Reel Standard per ANSI/EIA-481

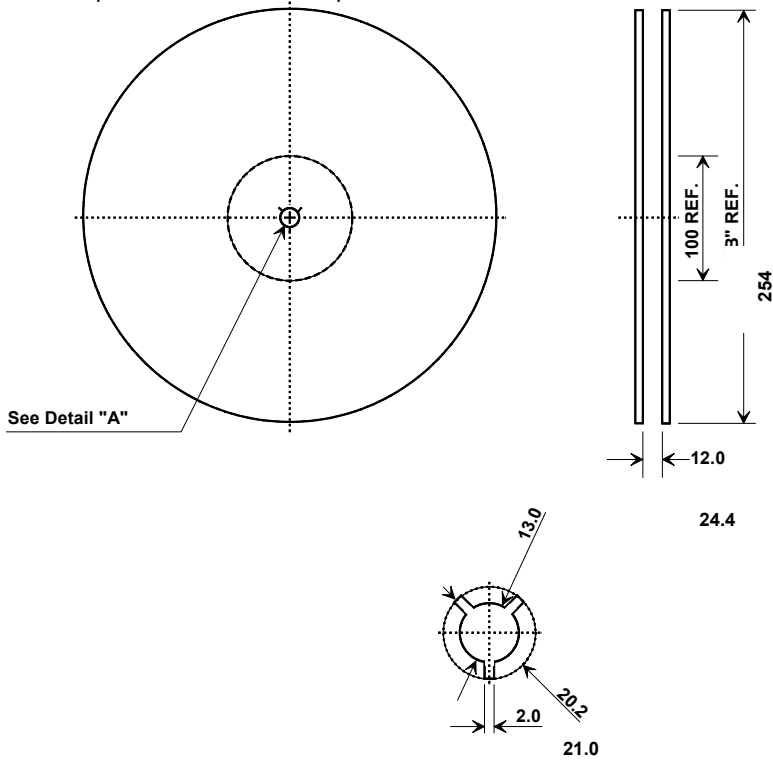

Quantity Per Reel	
500	Min
1000	Max

COMPONENT ORIENTATION and DIMENSIONS

Carrier Tape Dimensions	
Ao	7.0 mm
Bo	13.8 mm
Ko	2.0 mm
Pitch	12.0 mm
W	24.0 mm

