

SF2164E

1484.3 MHz
SAW Filter

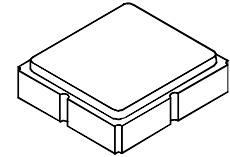

SM3030-8

- **SAW Filter for Digital Television**
- **Complies with Directive 2002/95/EC (RoHS)**
- **Moisture Sensitivity Level: 1**

Characteristics:

Differential Source and Load Configuration

Terminating Source/Load Impedance : $Z_S = 150 \Omega$

Maximum Rating

Rating	Value	Units
Input Power Level	+10	dBm
DC Voltage on any Non-ground Terminal	3	V
Operable Temperature Range	-45 to +125	°C
Specification Temperature Range	-40 to +85	°C
Storage Temperature Range	-50 to +95	°C
Soldering Reflow Temperature - 5 Cycles Maximum	260 °C for 10 seconds	

Electrical Characteristics

Characteristic	Sym	Notes	Min	Typ	Max	Units
Center Frequency	f_C			1484.3		MHz
Insertion Loss, 1464.3 to 1504.3 MHz	IL			2.0	4.5	dB
Amplitude Ripple, 1464.3 to 1504.3 MHz				0.6	2.0	dB
Phase Error, 1464.3 to 1504.3 MHz				3.2	6.0	deg
Input/Output VSWR, 1464.3 to 1504.3 MHz				2:1	2.5:1	
2 dB Bandwidth			40	60		MHz
Attenuation Referenced to 0 dB:						
50 to 1402.3 MHz			48	60		dB
1566.3 to 1810.5 MHz			50	60		
1810.5 to 4250 MHz			55	65		
4250 to 6000 MHz			30	38		

Case Style	SM3030-8 3.0 x 3.0 mm Nominal Footprint
Lid Symbolization, Y=year, WW=week, S=shift, dot=pin 1 indicator	860, <u>YWWS</u>

Electrical Connections

	Connection	Terminals
Port 1	Balanced Input	1,2
Port 2	Balanced Output	5,6
	Ground	All Others

Dot Indicates Pin 1



CAUTION: Electrostatic Sensitive Device. Observe precautions for handling.

NOTES:

1. The design, manufacturing process, and specifications of this device are subject to change.
2. US or International patents may apply.
3. RoHS compliant from the first date of manufacture.

Passband Amplitude and SWR Response

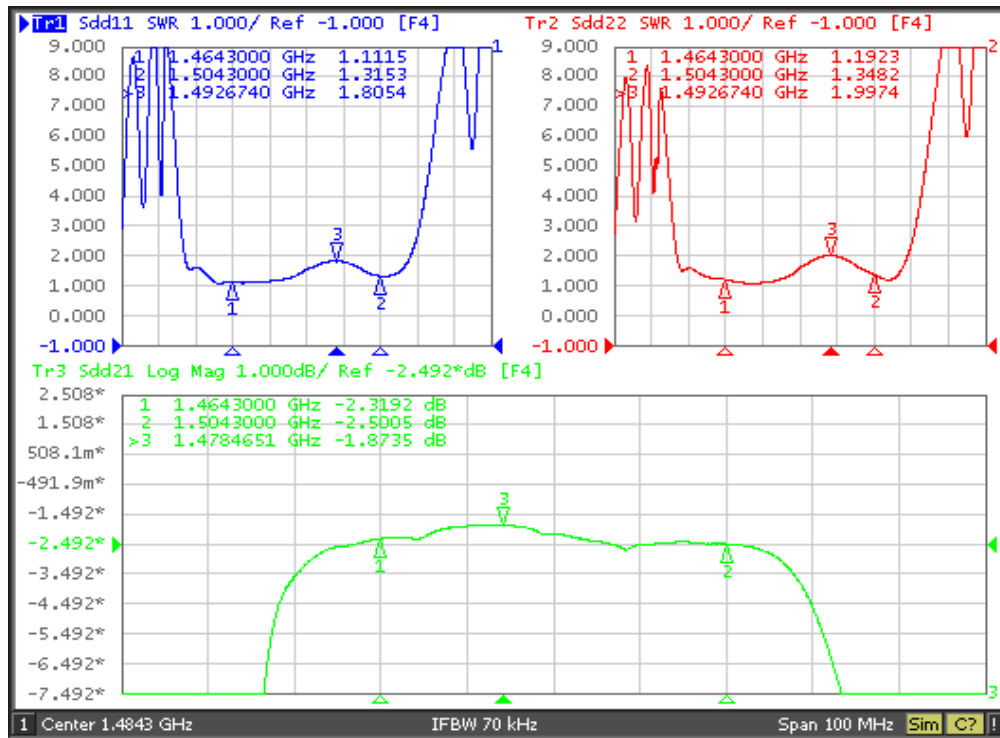

Broadband Response

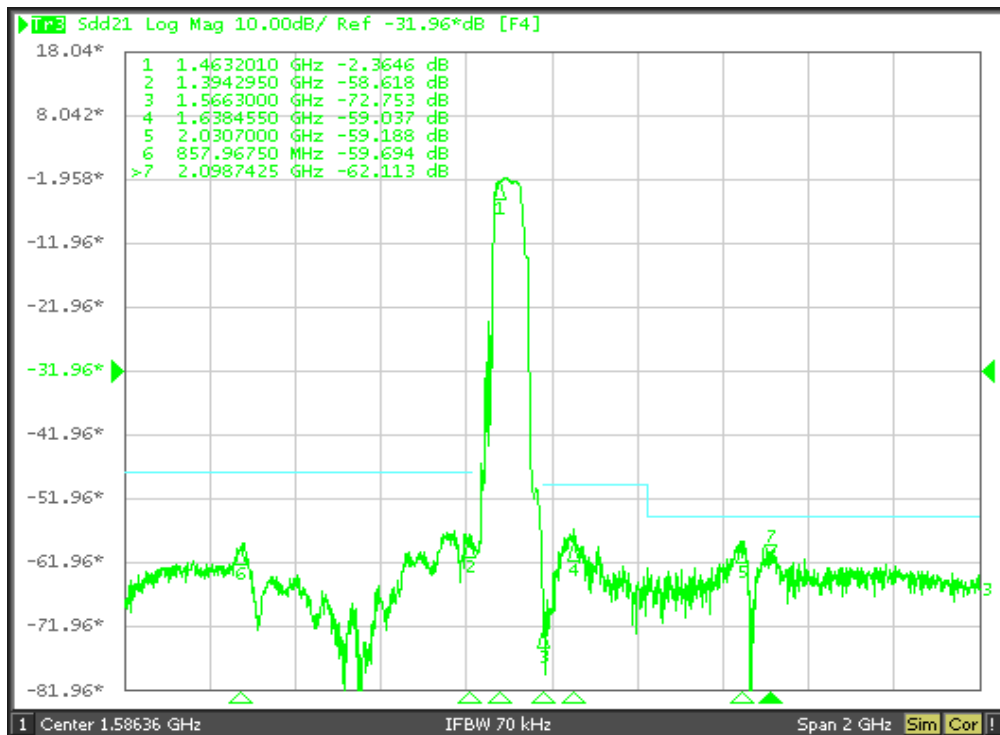

S₁₁, S₂₂ and S₂₁ Plots

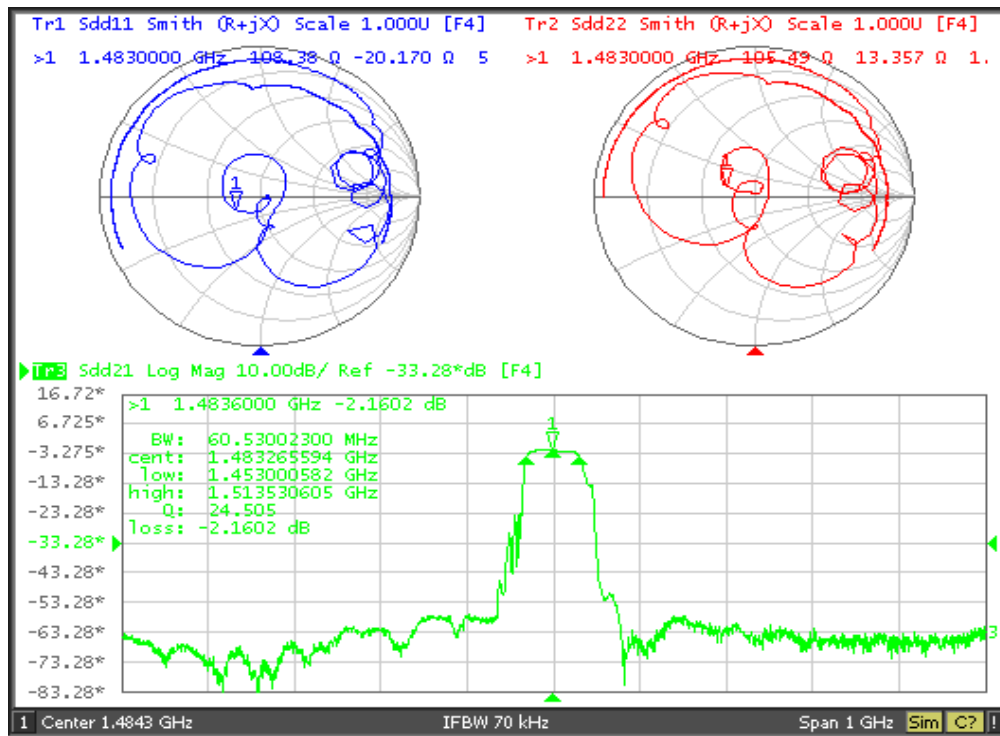

Test Circuit, Bottom View

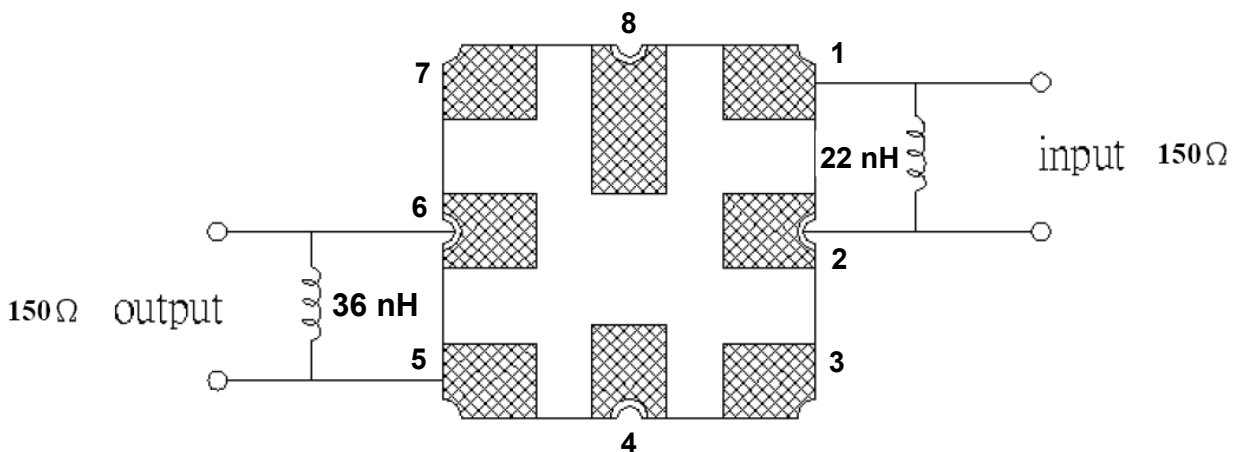

8-Terminal Ceramic Surface-Mount Case 3.0 X 3.0 mm Nominal Footprint

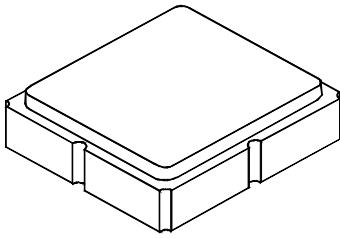

Case and PCB Footprint Dimensions

Dimension	mm			Inches		
	Min	Nom	Max	Min	Nom	Max
A	2.87	3.0	3.13	0.113	0.118	0.123
B	2.87	3.0	3.13	0.113	0.118	0.123
C	1.14	1.27	1.40	0.045	0.050	0.055
D	0.79	0.92	1.05	0.031	0.036	0.041
E	0.62	0.75	0.88	0.024	0.029	0.034
F	0.47	0.60	0.73	0.018	0.024	0.029
G	0.47	0.60	0.73	0.018	0.024	0.029
H	1.07	1.20	1.33	0.042	0.047	0.052
I		3.19			0.126	
J		0.81			0.032	
K		0.96			0.038	
L		0.81			0.032	
M		1.39			0.055	
N		0.23			0.009	
O		0.38			0.015	

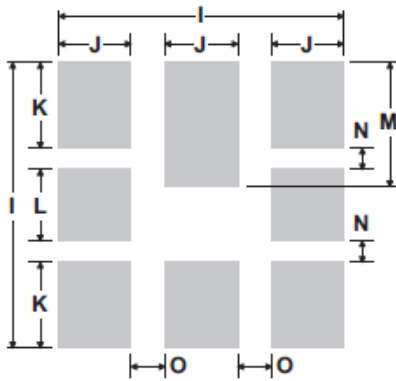

PCB Footprint Top View

Case Materials

Materials	
Solder Pad Plating	0.3 to 1.0 μm Gold over 1.27 to 8.89 μm Nickel
Lid Plating	2.0 to 3.0 μm Nickel
Body	Al_2O_3 Ceramic

TOP VIEW

BOTTOM VIEW

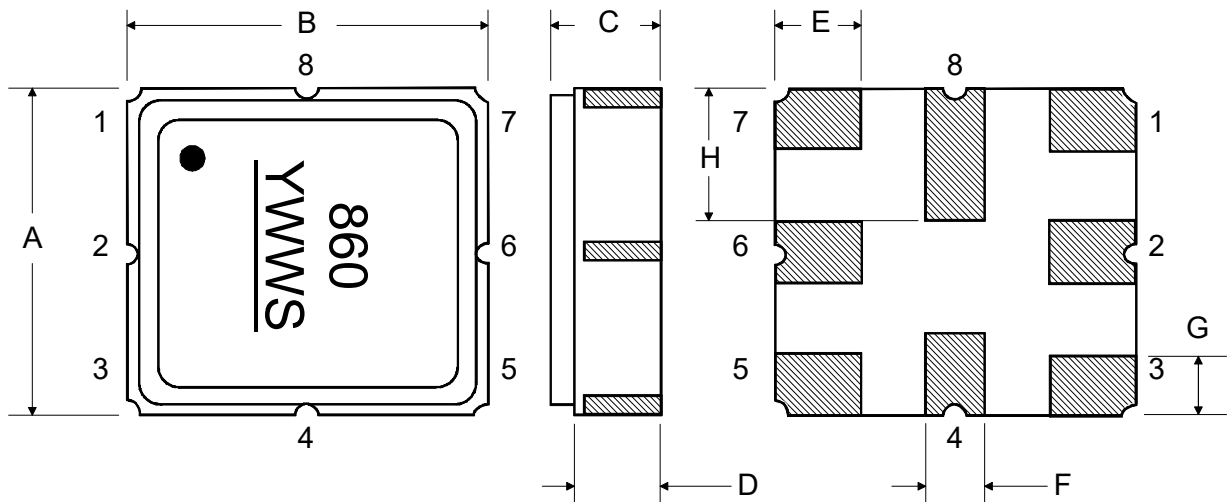

Tape and Reel Specifications

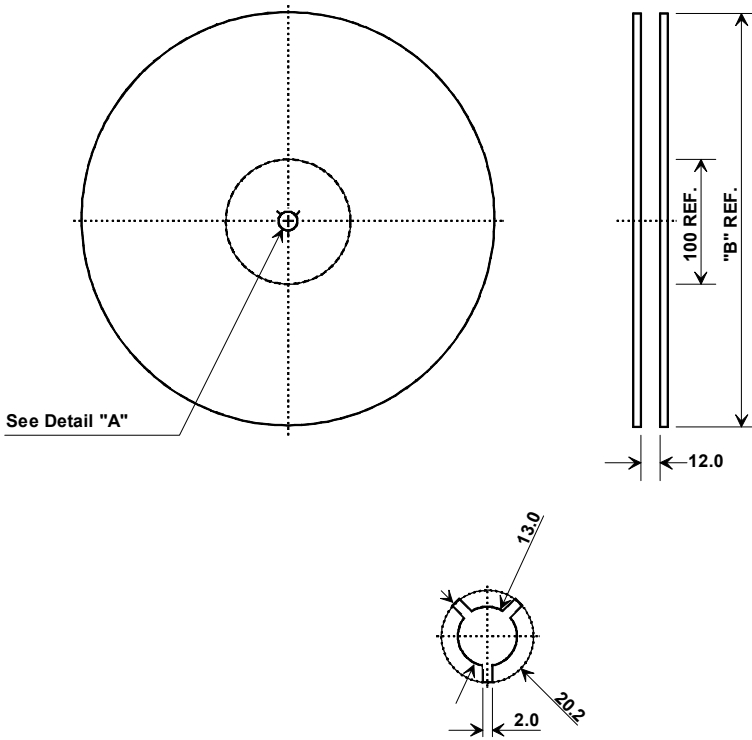

Tape and Reel Standard per ANSI/EIA-481

"B"		Quantity Per Reel
Inches	millimeters	
7	178	500
13	330	3000

COMPONENT ORIENTATION and DIMENSIONS

Carrier Tape Dimensions	
Ao	3.35 mm
Bo	3.35 mm
Ko	1.4 mm
Pitch	8.0 mm
W	12.0 mm

