

SF2189A

**140 MHz
SAW Filter**

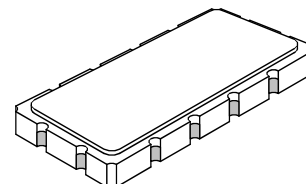

SM13365-12

- Precision IF SAW Filter
- Hermetic 13.3 x 6.5 mm Surface-mount Case
- Complies with Directive 2002/95/EC (RoHS)
- Moisture Sensitivity Level: 1

Absolute Maximum Ratings

Rating	Value	Units
Maximum Incident Power in Passband	+10	dBm
Maximum DC Voltage between any Two Terminals	3	VDC
Storage Temperature Range in Tape and Reel	-40 to +85	°C
Suitable for Lead-free Soldering - Maximum Soldering Profile	260°C for 30 s	

Electrical Characteristics

Characteristic	Sym	Notes	Min	Typ	Max	Units
Center Frequency	F_C			140		MHz
Minimum Insertion Loss	IL_{MIN}			11.3	13.0	dB
1 dB Bandwidth	BW_1		30.0	33.0		MHz
3 dB Bandwidth	BW_3		32.0	35.0		MHz
35 dB Bandwidth	BW_{35}			42.4	44.0	MHz
Passband Amplitude Ripple, 80% of 3 dB Bandwidth				0.6	1.2	dB _{p-p}
Passband Group Delay Ripple, 80% of 3 dB Bandwidth				50	120	ns _{p-p}
Passband Absolute Group Delay				0.55		µs
Passband Phase Linearity, 80% of 3 dB Bandwidth				5	14	deg _{p-p}
Specification Temperature Range			-20		+80	°C
Operable Temperature Range			-45		+125	°C
Frequency Temperature Coefficient				-94		ppm/°C
Source Impedance				50		ohm
Load Impedance				50		ohm

Case Style	SM13365-12 13.3 x 6.5 mm Nominal Footprint
Lid Symbolization (YY = year, WW = week, S = Shift, ## = Sequence Code)	SF2189A YYWWS##

 **CAUTION: Electrostatic Sensitive Device. Observe precautions for handling.**

NOTES:

1. The design, manufacturing process, and specifications of this device are subject to change.
2. US or International patents may apply.
3. RoHS compliant from the first date of manufacture.

SF2189A Filter Response

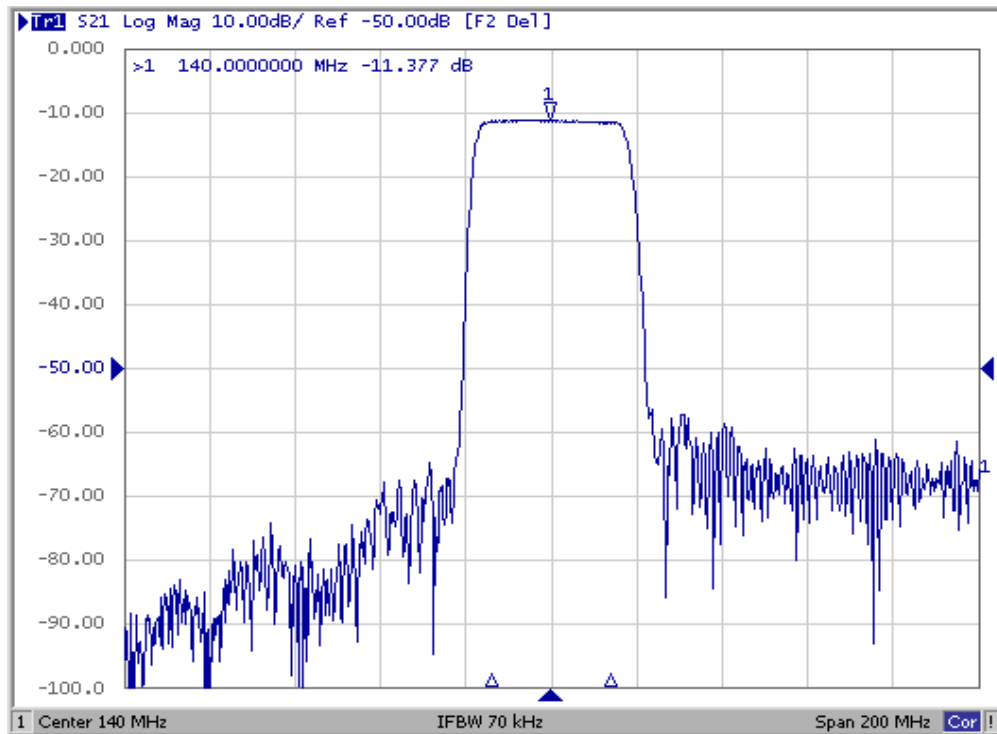

SF2189A Passband Amplitude and Group Delay Ripple

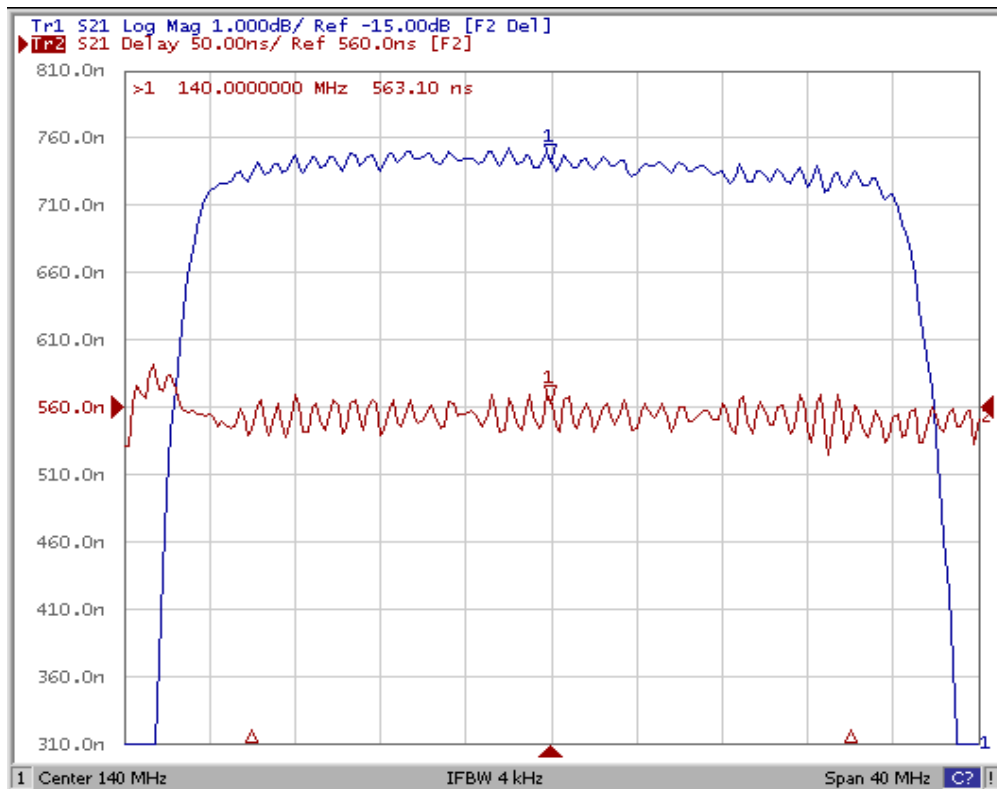

SF2189A Input Impedance (K Port)

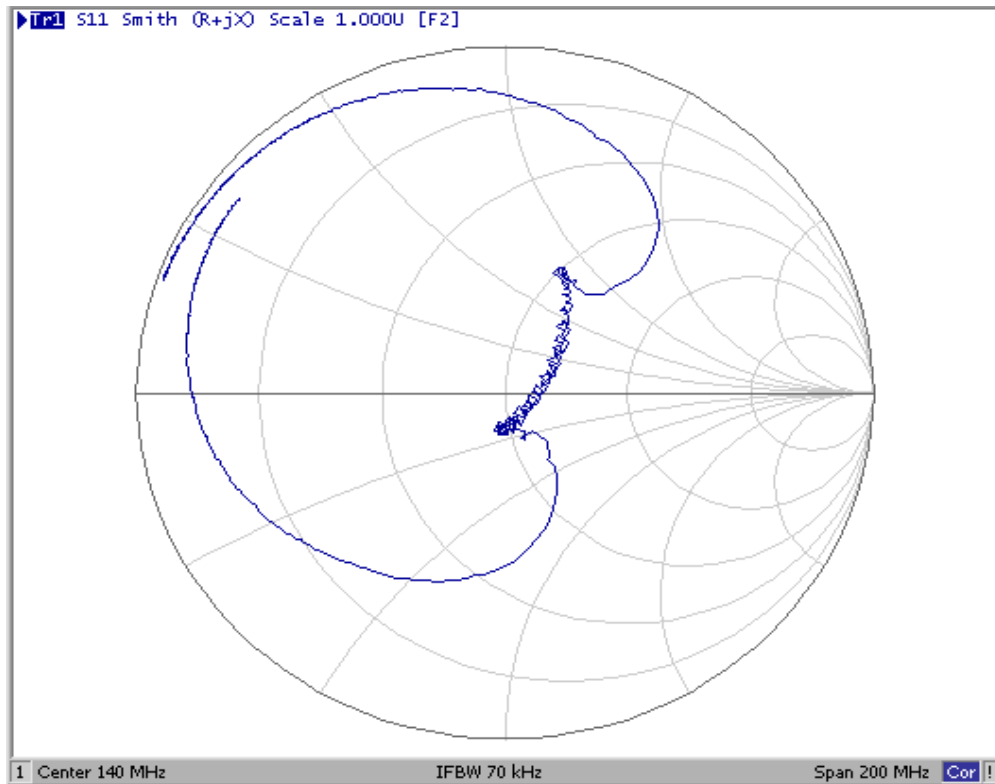

SF2189A Output Impedance (E Port)

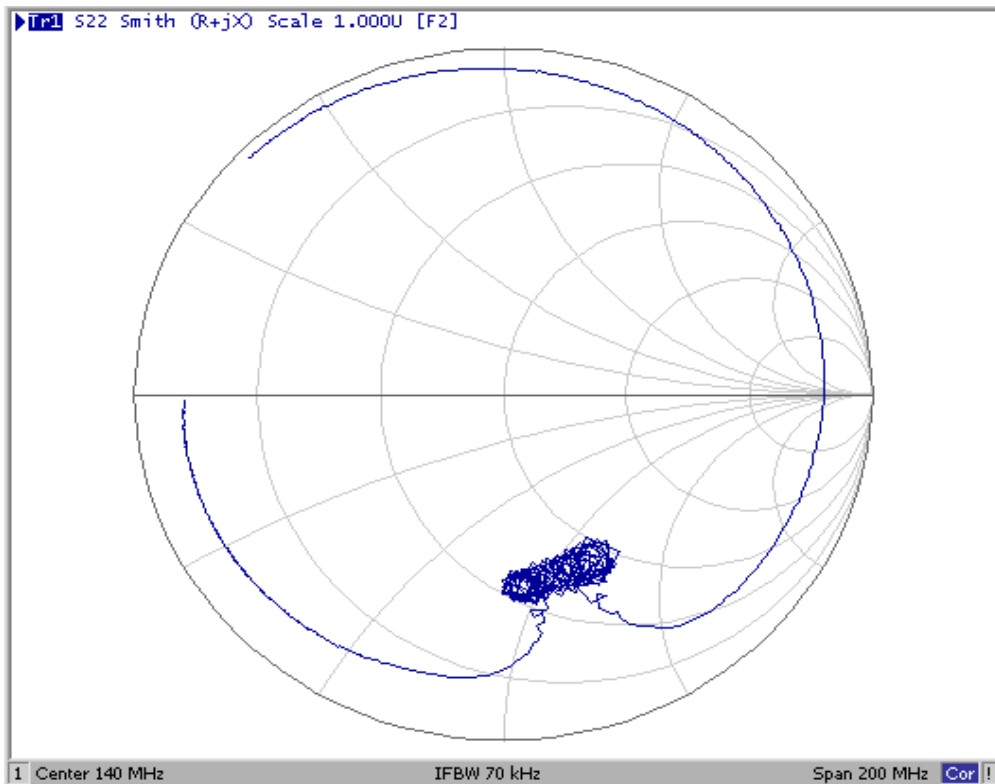

SF2189A 50 ohm Matching Network

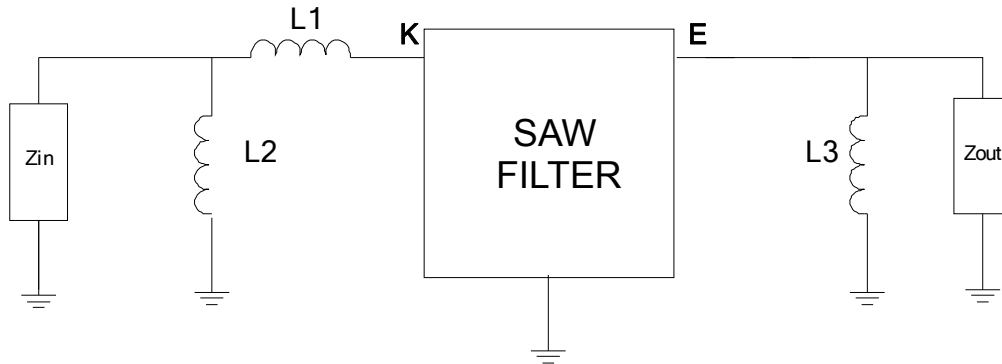

$$L1 = 10 \text{ nH}, L2 = 27 \text{ nH}, L3 = 68 \text{ nH}$$

SF2189A PCB Pad Layout

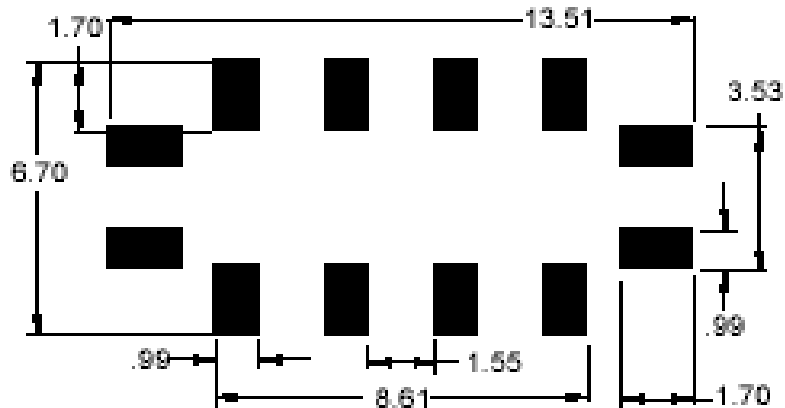

SM13365-12 Case

12-Terminal Ceramic Surface-Mount Case

13.3 x 6.5 mm Nominal Footprint

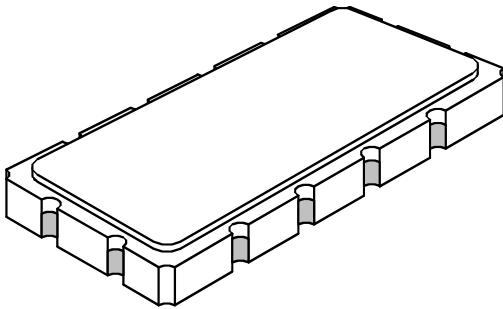

Case Dimensions

Dimension	mm			Inches		
	Min	Nom	Max	Min	Nom	Max
A	13.08	13.31	13.60	0.515	0.524	0.535
B	6.27	6.50	6.80	0.247	0.256	0.268
C		1.91	2.00		0.075	0.079
D		1.50			0.059	
E		0.79			0.031	
H		1.0			0.039	
P		2.54			0.100	

Electrical Connections

Connection	Terminals
Input	K
Output	E
Case Ground	All others

Materials

Solder Pad Plating	0.3 to 1.0 μm Gold over 1.27 to 8.89 μm Nickel
Lid Plating	2.0 to 3.0 μm Nickel
Body	Al_2O_3 Ceramic

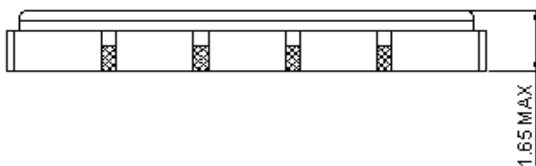
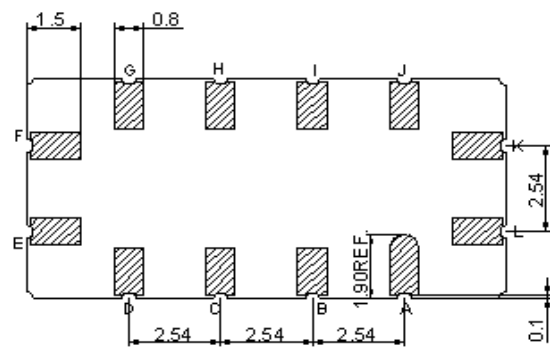
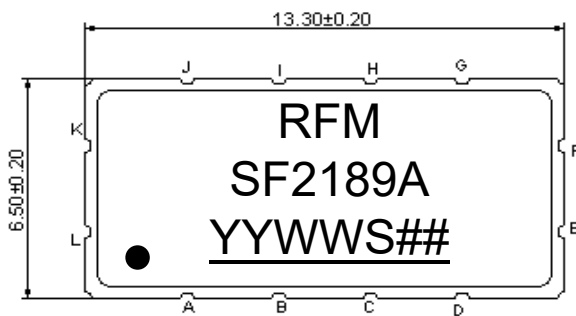

Tape and Reel Specifications

Tape and Reel Standard per ANSI/EIA-481

Reel Count:
7" = 500
13" = 1000

