

**SF2190B**

**138 MHz**  
**SAW Filter**

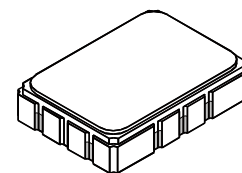

**SMP-03**

- *Small Size*
- *Hermetic 5 X 7 mm Surface-mount Case*
- *Differential Input/Output*
- *Complies with Directive 2002/95/EC (RoHS)*
- *Moisture Sensitivity Level: 1*
- *AEC-Q200 Qualified*

**Absolute Maximum Ratings**

Rating	Value	Units
Maximum Incident Power in Passband	+10	dBm
Maximum DC Voltage Between any Two Terminals	3	VDC
Operating Temperature Range	-40 to +85	°C
Storage Temperature Range in Tape and Reel	-40 to +85	°C
Maximum Soldering Profile	265°C for 10 s	

**Electrical Characteristics**

Characteristic	Sym	Notes	Min	Typ	Max	Units
Center Frequency	$F_C$			138		MHz
Insertion Loss	IL			18.8	21.0	dB
1 dB Bandwidth			60	63		MHz
3 dB Bandwidth				65.4		MHz
Amplitude Ripple Across 1 dB Bandwidth				0.6	1.2	dB <sub>p-p</sub>
Upper -35 dB Band Edge				176	179	MHz
Lower -35 dB Band Edge			97	101		MHz
Ultimate Rejection			35	40		dB
Temperature Coefficient				-72		ppm/°C
Source Impedance, Balanced				50		ohm
Load Impedance, Balanced				50		ohm

Case Style	SMP-03 5 X 7 mm Nominal Footprint
Lid Symbolization (YY=year, WW=week, S=shift, ## = Sequence Code)	RFM, SF2190B, <u>YYWWS##</u>



**CAUTION: Electrostatic Sensitive Device. Observe precautions for handling.**

**NOTES:**

1. The design, manufacturing process, and specifications of this device are subject to change.
2. US or International patents may apply.
3. RoHS compliant from the first date of manufacture.

## SF2190B Response, 38 to 238 MHz

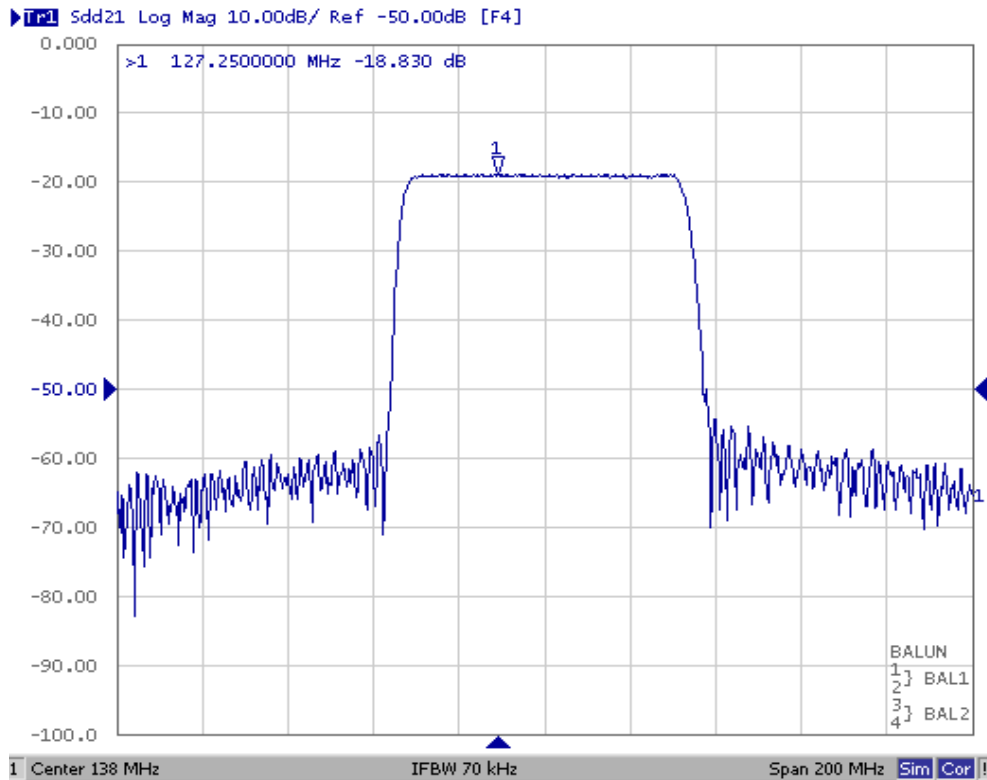

## SF2190B Passband Response

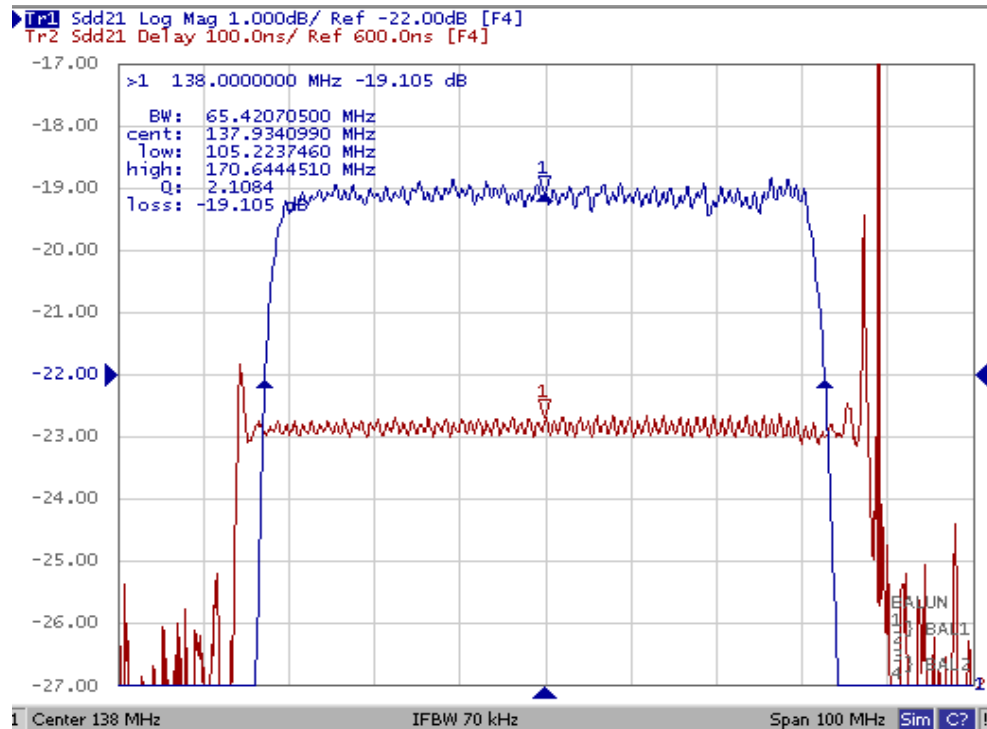

# SF2190B Response, 300 kHz to 600 MHz

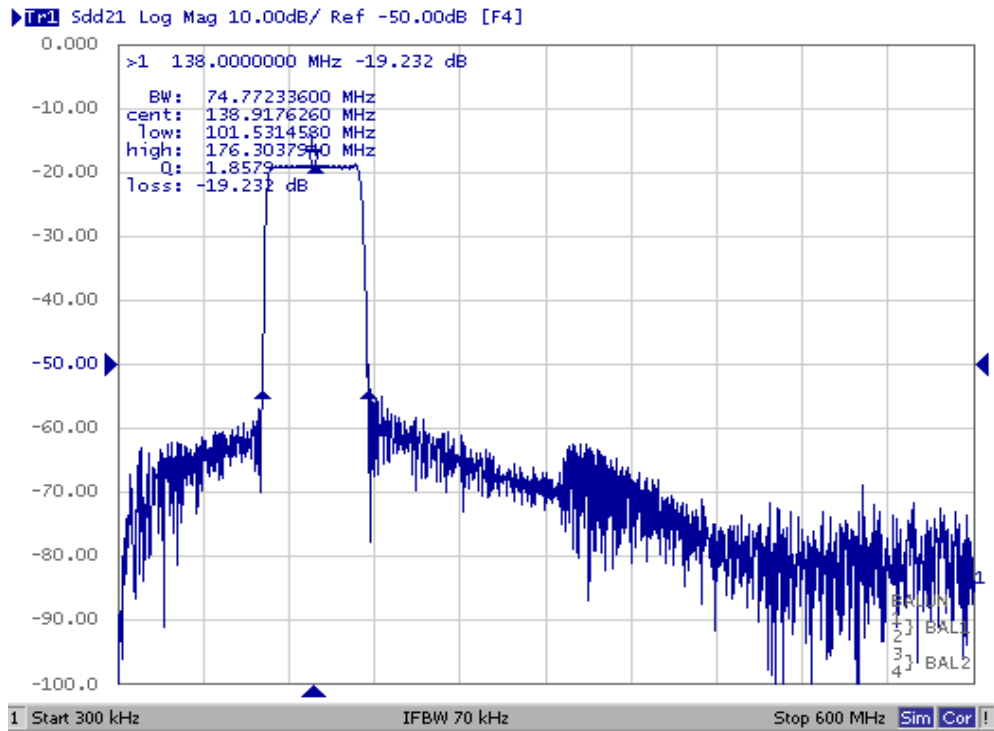

# 10-Terminal Ceramic Surface-Mount Case

## 5 x 7 mm Nominal Footprint

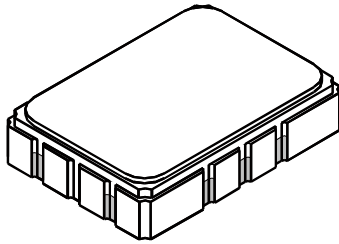

SMP-03 Package

### Matching Network

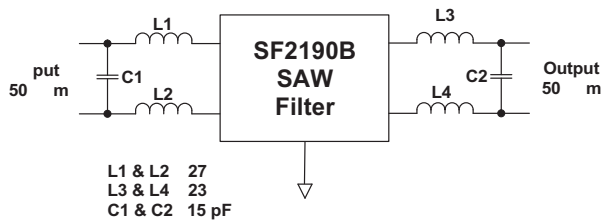

### Case Dimensions

Dimension	mm			Inches		
	Min	Nom	Max	Min	Nom	Max
A	6.80	7.00	7.20	0.268	0.276	0.283
B	4.80	5.00	5.20	0.189	0.197	0.205
C		1.65	2.00		0.065	0.079
D		0.60			0.024	
E		2.54			0.100	
H		1.0			0.039	
J		5.00			0.197	
K		3.00			0.118	
P		1.27			0.050	

### Electrical Connections

Connection		Terminals
Port 1	Balanced Input	10
	Balanced Input	1
Port 2	Balanced Output	5
	Balanced Output	6
Ground		All others

### Case Materials

Materials	
Solder Pad Plating	0.3 to 1.0 $\mu\text{m}$ Gold over 1.27 to 8.89 $\mu\text{m}$ Nickel
Lid Plating	2.0 to 3.0 $\mu\text{m}$ Nickel
Body	$\text{Al}_2\text{O}_3$ Ceramic

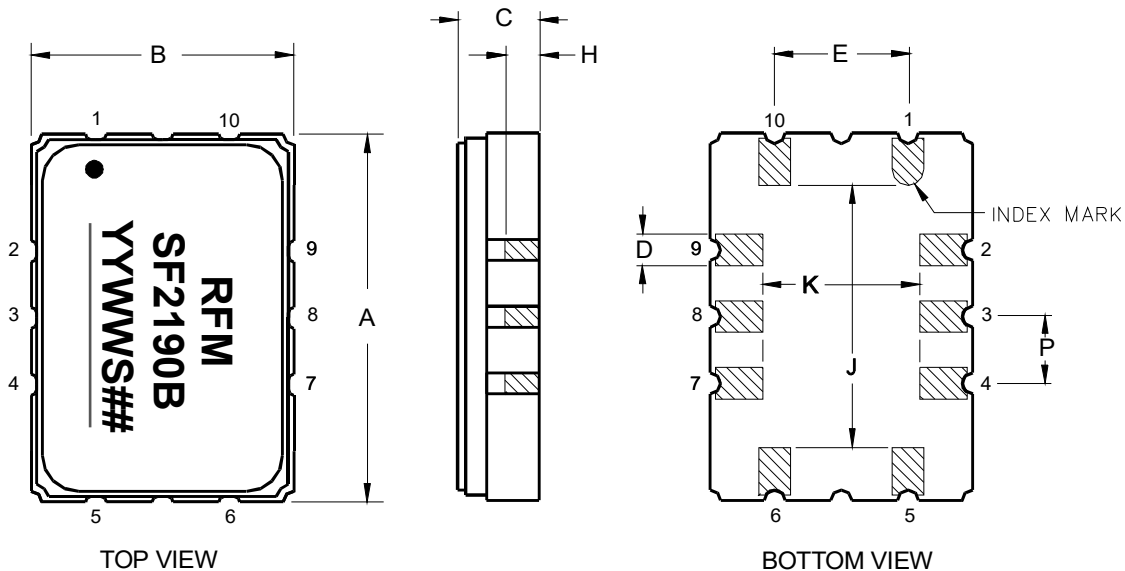

## Tape and Reel Specifications

Tape and Reel Standard per ANSI/EIA-481

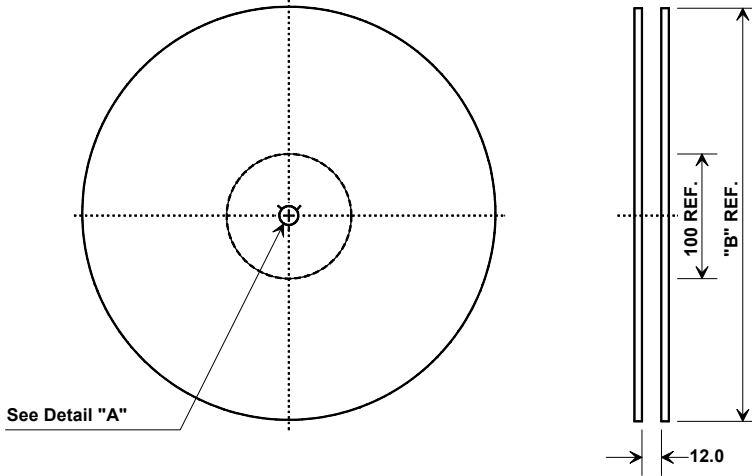

"B" Nominal Size		Quantity Per Reel
Inches	millimeters	
7	178	500
13	330	2000

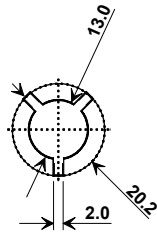

### Component Orientation and Dimensions

Carrier Tape Dimensions	
Ao	9.4 mm
Bo	7.4 mm
Ko	2.0 mm
Pitch	8.0 mm
W	16.0 mm

