



- *Miniature High Performance SAW Filter*
- *Low Passband Loss*
- *Hermetic 1.4 x 1.1 mm Surface-mount Case*
- *Complies with Directive 2002/95/EC (RoHS)*



SF2316K-1

**1588.655 MHz
SAW Filter**

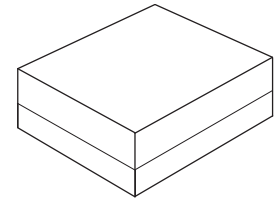

SM1411-5

Absolute Maximum Ratings

| Rating | Value | Units |
|--|-----------------|-------|
| Maximum Incident Power in Passband | +10 | dBm |
| Maximum DC Voltage On any Non-ground Terminal | 3 | VDC |
| Component Operating Temperature Range | -40 to +105 | °C |
| Storage Temperature Range in Tape and Reel | -40 to +105 | °C |
| Maximum Soldering Temperature Profile (5 cycles maximum) | 265 °C for 10 s | |
| Moisture Sensitivity Level: 2A | | |

Electrical Characteristics

| Characteristic | Sym | Notes | Min | Typ | Max | Units |
|--|------------|-------|----------|------|------|-------|
| Center Frequency | f_c | | 1588.655 | | | MHz |
| Insertion Loss, 1573.42 to 1577.42 MHz | IL_{MAX} | | | 1.25 | 1.90 | dB |
| Insertion Loss, 1571.42 to 1605.89 MHz | | | | 1.85 | 2.50 | |
| Amplitude Ripple, 1573.42 to 1577.42 MHz | | | | 0.25 | 1.20 | dB |
| Amplitude Ripple, 1571.42 to 1605.89 MHz | | | | 0.80 | 1.50 | |
| Attenuation | | | | | | dB |
| DC to 824 MHz | | | 32 | 36 | | |
| 824 to 849 MHz | | | 32 | 36 | | |
| 849 to 880 MHz | | | 32 | 36 | | |
| 880 to 915 MHz | | | 32 | 36 | | |
| 915 to 1452 MHz | | | 32 | 36 | | |
| 1452 to 1525 MHz | | | 35 | 39 | | |
| 1710 to 1785 MHz | | | 35 | 38 | | |
| 1785 to 1850 MHz | | | 30 | 37 | | |
| 1850 to 6000 MHz | | | 25 | 37 | | |
| I/O VSWR, 1573.42 to 1577.42 MHz | | | | 1.9 | 2.3 | |
| I/O VSWR, 1571.42 to 1605.89 MHz | | | | 2.0 | 2.3 | |
| Temperature Coefficient of Frequency | ppm/°C | | | -36 | | |
| Case Style | | | SM1411-5 | | | |
| Lid Symbolization | | | R | | | |



CAUTION: Electrostatic Sensitive Device. Observe precautions for handling.

NOTES:

1. The design, manufacturing process, and specifications of this device are subject to change.
2. US or International patents may apply.
3. RoHS compliant from the first date of manufacture.

Frequency Response Plots

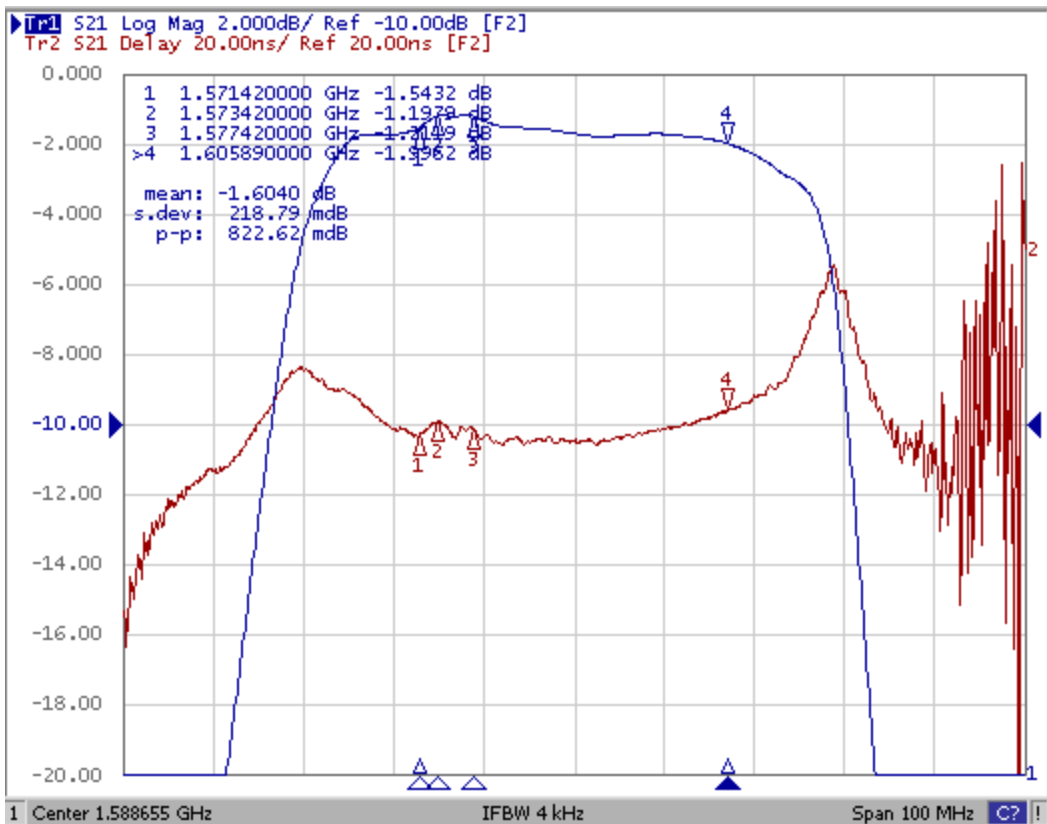
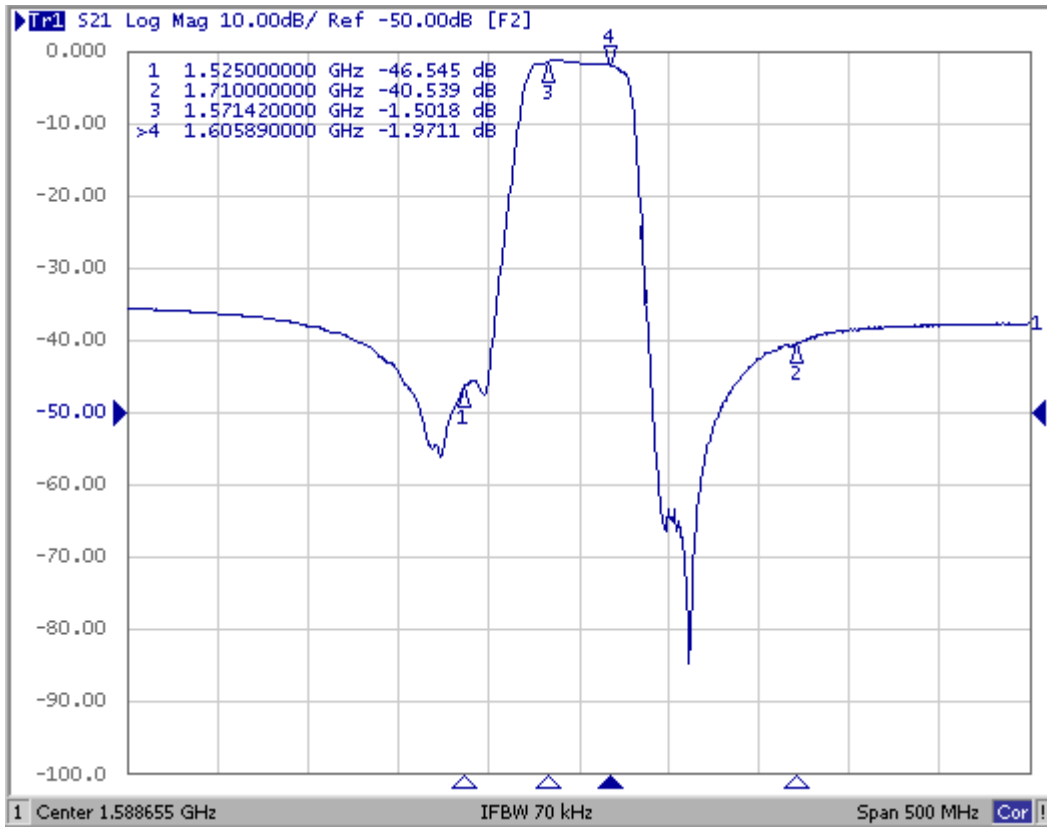

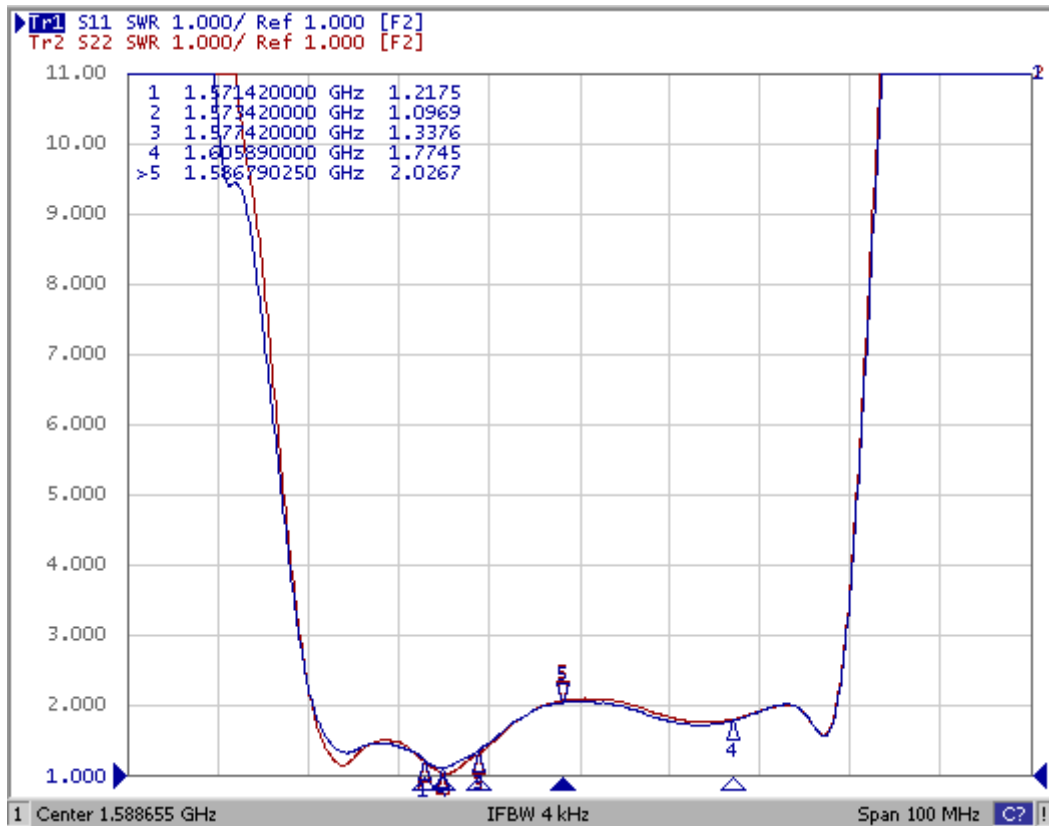
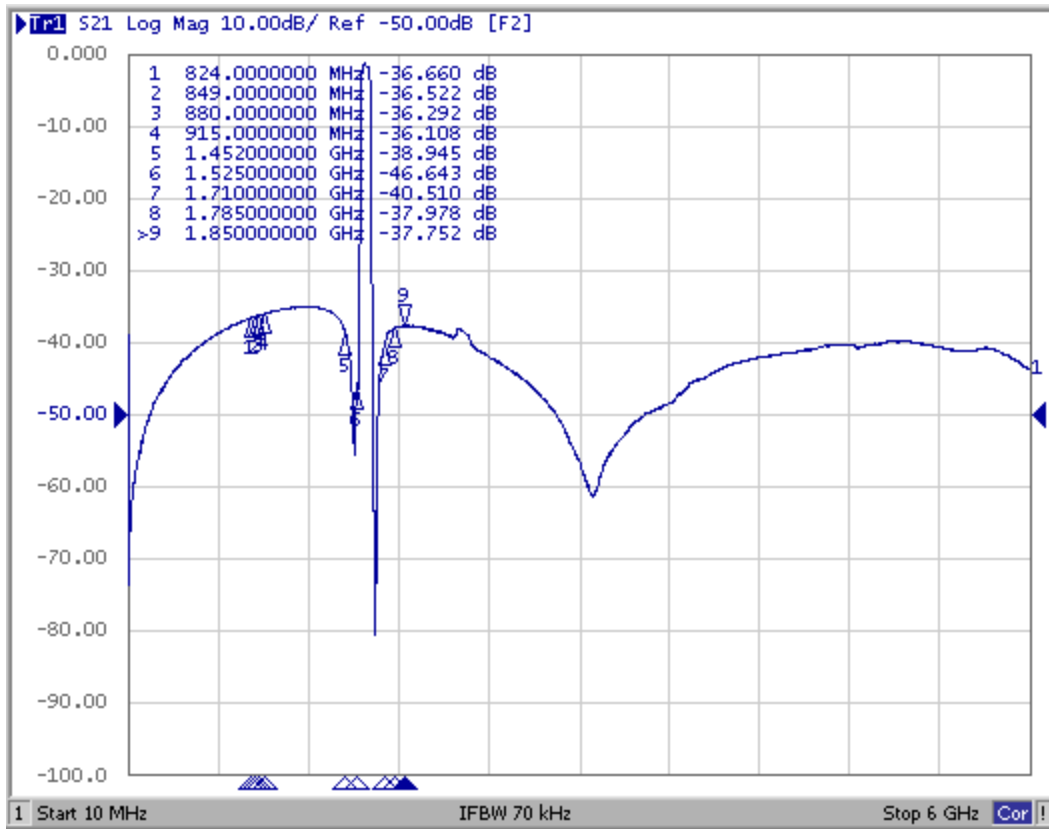

SM1411-5 1.4 X 1.1 mm 5-Terminal Surface-mount Case

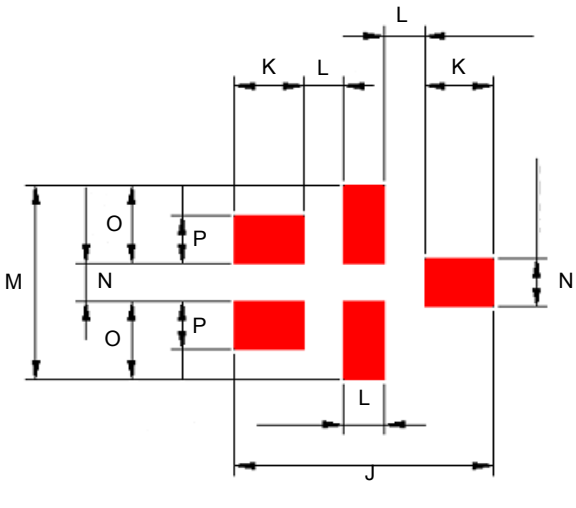
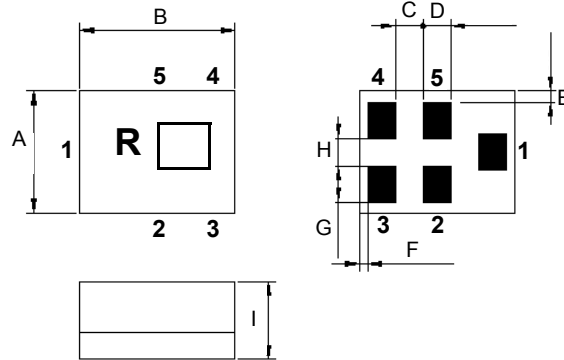

| Dimension | mm | | | Inches | | |
|-----------|-----|-------|-------|--------|-------|-------|
| | Min | Nom | Max | Min | Nom | Max |
| A | - | 1.10 | - | - | 0.043 | - |
| B | - | 1.40 | - | - | 0.055 | - |
| C | - | 0.25 | - | - | 0.009 | - |
| D | - | 0.25 | - | - | 0.009 | - |
| E | - | 0.10 | - | - | 0.003 | - |
| F | - | 0.075 | - | - | 0.002 | - |
| G | - | 0.325 | - | - | 0.012 | - |
| H | - | 0.25 | - | - | 0.009 | - |
| I | - | - | 0.700 | - | - | 0.027 |
| J | - | 1.60 | - | - | 0.062 | - |
| K | - | 0.425 | - | - | 0.016 | - |
| L | - | 0.25 | - | - | 0.009 | - |
| M | - | 1.30 | - | - | 0.051 | - |
| N | - | 0.325 | - | - | 0.012 | - |
| O | - | 0.525 | - | - | 0.020 | - |
| P | - | 0.325 | - | - | 0.012 | - |

PCB Footprint

| Materials | |
|--------------------|--|
| Solder Pad Plating | 0.3 to 1.0 μm Gold over 1.27 to 8.89 μm Nickel |
| Body | Al_2O_3 Ceramic |
| Pb Free | |

Test Circuit

