

SF2424D

**505 MHz
SAW Filter**

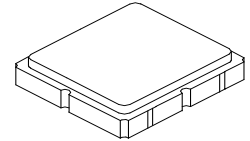

SM3838-8

- **Hermetically sealed Surface Mount package**
- **Complies with Directive 2002/95/EC (RoHS)**
- **Moisture Sensitivity Level: 1**

Absolute Maximum Ratings

Rating	Value	Units
Maximum Input Power	10	dBm
DC Voltage	10	VDC
Operating Temperature	-40 to +85	°C
Storage Temperature	-40 to +85	°C

Electrical Characteristics

Characteristic	Sym	Notes	Minimum	Typical	Maximum	Units			
Center Frequency	f_c			505		MHz			
Insertion Loss	IL	500 - 508 MHz		2.6	4.1	dB			
		500 - 510 MHz		2.8	4.1				
Amplitude Ripple		500 - 508 MHz		0.5	2.5	dB			
		500 - 510 MHz		0.6	2.5				
Attenuation (Reference level from 0dB)						dB			
							404 to 463.2 MHz	42	50
							544 to 604 MHz	42	48
Temperature Coefficient of Frequency				-36		ppm/k			
Terminating Source Impedance (single) Z_S				50		Ω			
Terminating Load Impedance (single) Z_L									
Footprint Size: 3.8 X 3.8			SM3838-8						
Lid Symbolization (Y=Year, WW=week, S=shift)			B38, YWWS						

Electrical Connections

Connection	Terminals
Input	2
Output	6
Ground	All Others

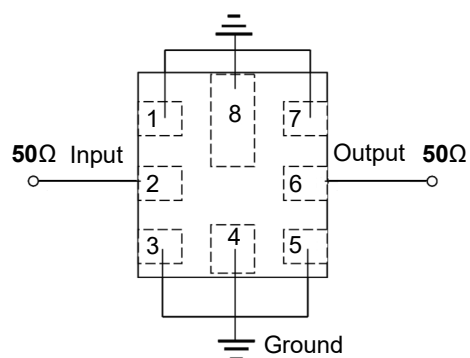

Frequency Characteristics

S21 Response: Center 504 MHz, Span 250 MHz

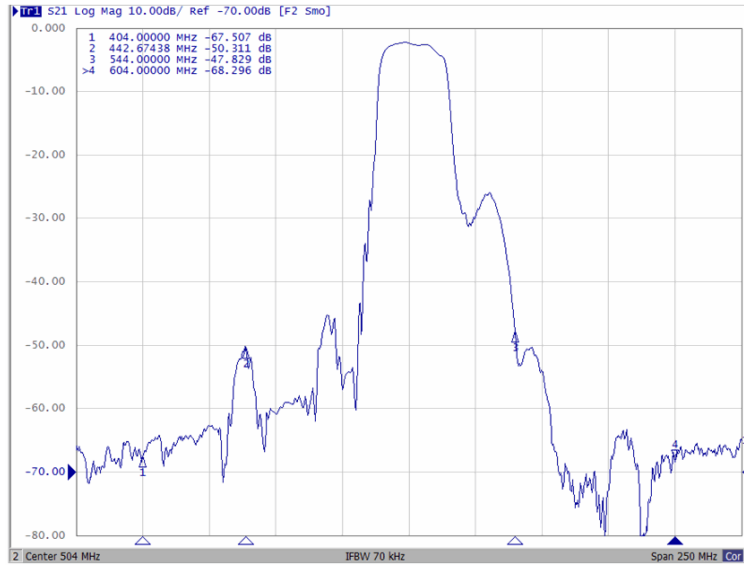

S21 Response: Span 40 MHz

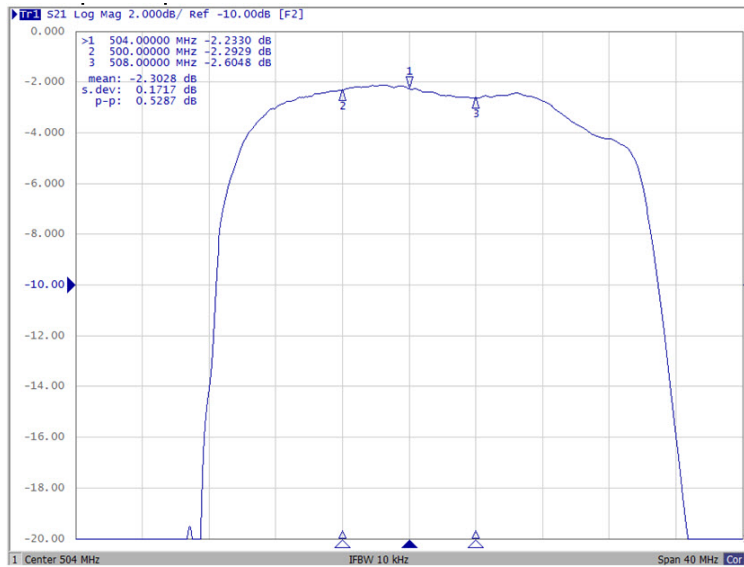

S21 Response: 0 - 1000 MHz

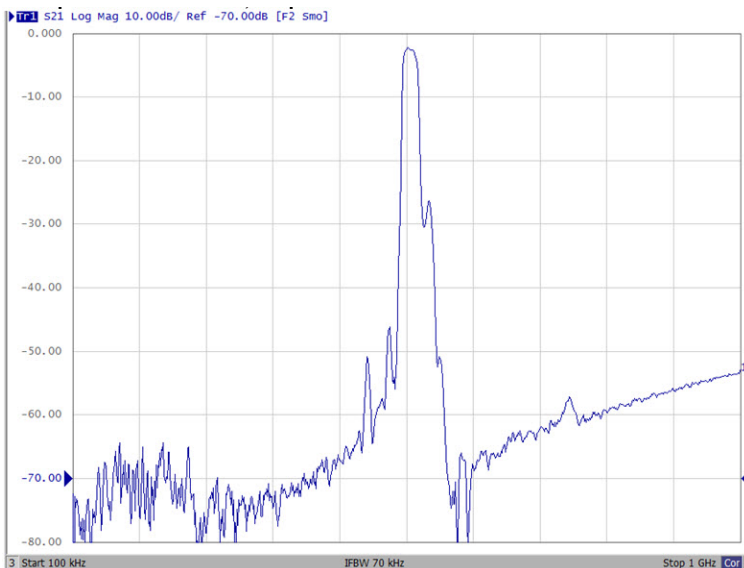

SM3838-8 Case

8-Terminal Ceramic Surface-Mount Case

3.8 X 3.8 mm Nominal Footprint

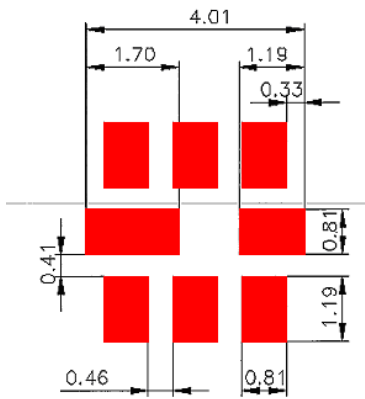
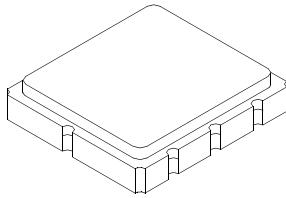

PCB Footprint

Case Dimensions						
Dimension	mm			Inches		
	Min	Nom	Max	Min	Nom	Max
A	3.65	3.80	3.95	0.143	0.149	0.155
B	3.65	3.80	3.95	0.143	0.149	0.155
C	-	-	1.40	-	-	0.055
D	0.95	1.10	1.25	0.037	0.043	0.049
E	0.90	1.00	1.10	0.035	0.040	0.043
F	0.50	0.60	0.70	0.020	0.024	0.028
G	2.39	2.54	2.69	0.090	0.100	0.110
H	1.40	1.75	2.05	0.055	0.069	0.080
I	0.90	1.00	1.10	0.035	0.040	0.043

Electrical Connections		
	Connection	Terminals
Port 1	Input	2
Port 2	Output	6
	Ground	All Others

Dot Indicates Pin 1

Materials	
Solder Pad Termination	Au plating 30 - 60 μ Inches (76.2-152 μ M) over 80-200 μ Inches (203-508 μ M) Ni.
Lid	Fe-Ni-Co Alloy Electroless Nickel Plate (8-11% Phosphorus) 100-200 μ Inches Thick
Body	Al ₂ O ₃ Ceramic

TOP VIEW

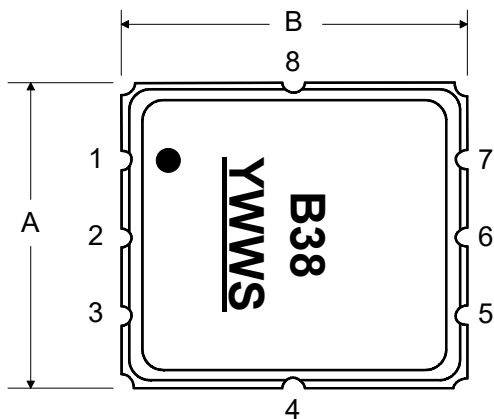

BOTTOM VIEW

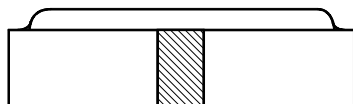
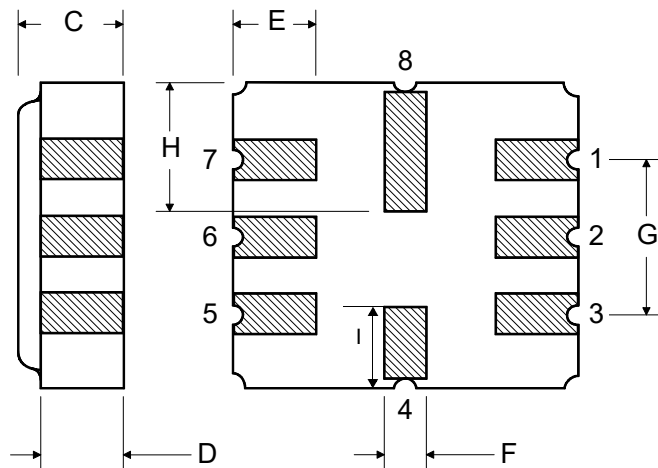

Tape and Reel Specifications

Tape and Reel Standard per ANSI/EIA-481

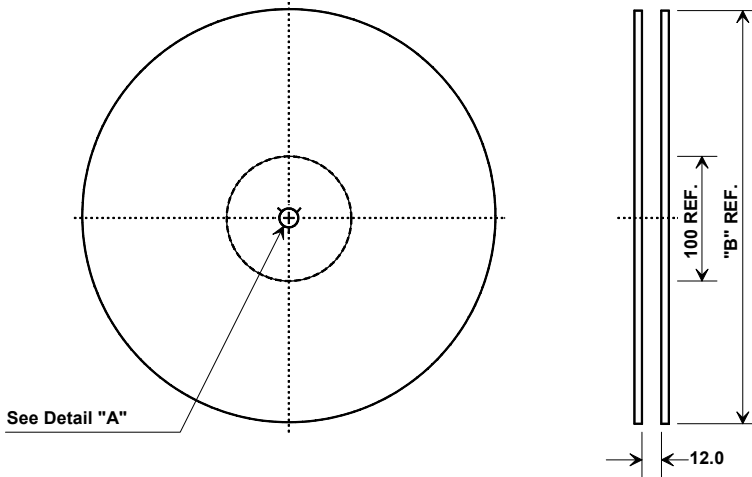

"B" Nominal Size		Quantity Per Reel
Inches	millimeters	
7	178	500
13	330	3000

See Detail "A"

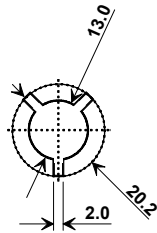

COMPONENT ORIENTATION and DIMENSIONS

Carrier Tape Dimensions	
Ao	4.25 mm
Bo	4.25 mm
Ko	1.30 mm
Pitch	8.0 mm
W	12.0 mm

