

**SF2431D**

**505 MHz  
SAW Filter**

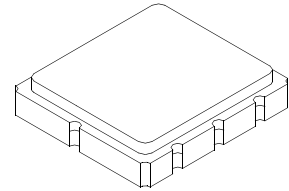

**SM3838-8**

- **High Performance SAW Filter**
- **3.8 x 3.8 mm Surface-mount Package**
- **Complies with Directive 2002/95/EC (RoHS)**
- **Moisture Sensitivity Level: 1**

**Absolute Maximum Ratings**

Rating	Value	Units
Maximum Incident Power in Passband	+10	dBm
Maximum DC Voltage Between any Two Active Terminals	3	VDC
Operable Temperature Range	-45 to +125	°C
Specification Temperature Range	-40 to +85	°C
Storage Temperature Range	-40 to +95	°C
Suitable for Lead-free Soldering - Maximum Soldering Profile	260 °C for 10 sec	

**Electrical Characteristics**

Characteristic	Sym	Notes	Min	Typ	Max	Units
Center Frequency	$f_c$			505		MHz
Insertion Loss (500 to 510 MHz)	ILmin			2.2	3.2	dB
Amplitude Ripple (500 to 510 MHz)				0.8	1.5	
Attenuation (Reference level from 0dB)						
0 to 485 MHz			40	50		dB
555 to 800 MHz			45	50		

Case Style	3.8 x 3.8 mm Nominal Footprint
Lid Symbolization, Y=year, WW=week, S=shift, Dot=pin 1 indicator	B41, YWWS

**Electrical Connections**

Connection	Terminals
Input	2
Output	6
Case Ground	All others

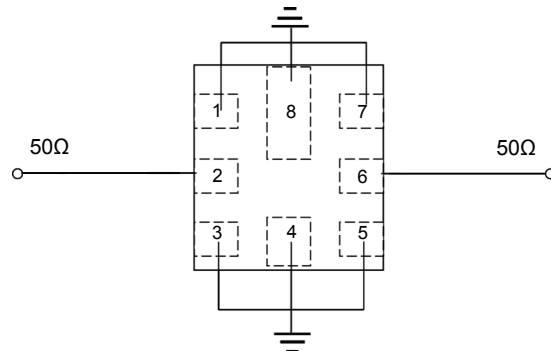

**CAUTION: Electrostatic Sensitive Device. Observe precautions for handling.**

**NOTES:**

1. The design, manufacturing process, and specifications of this device are subject to change.
2. US or International patents may apply.
3. RoHS compliant from the first date of manufacture.

## Frequency Characteristics

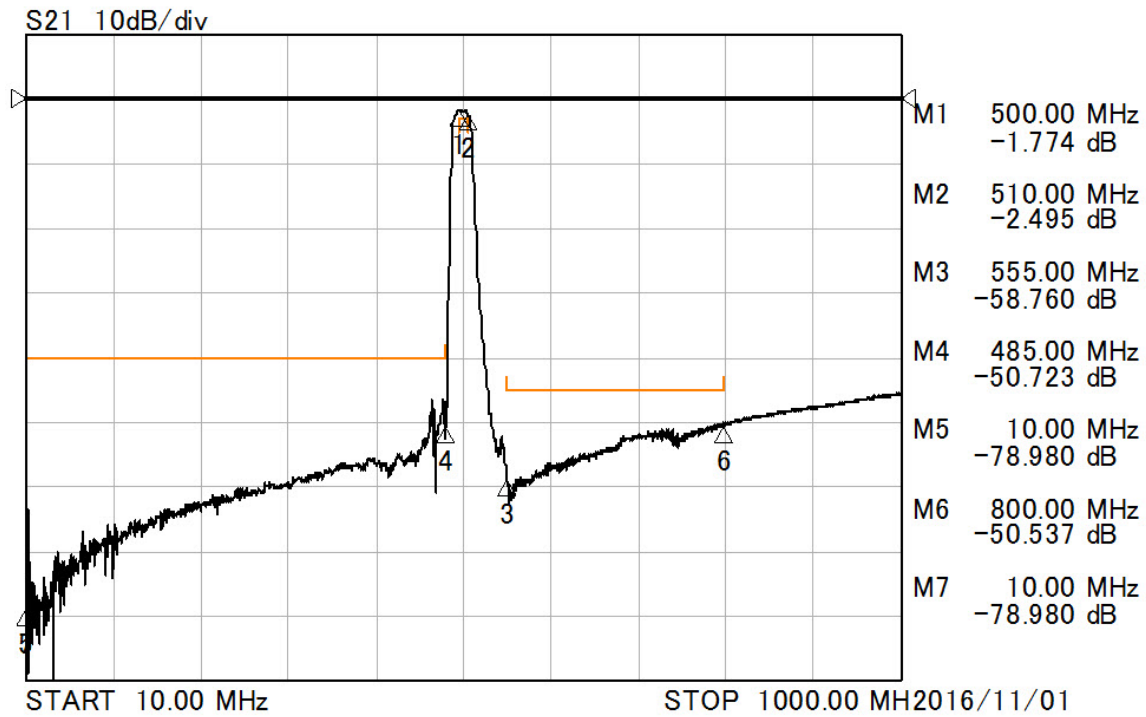
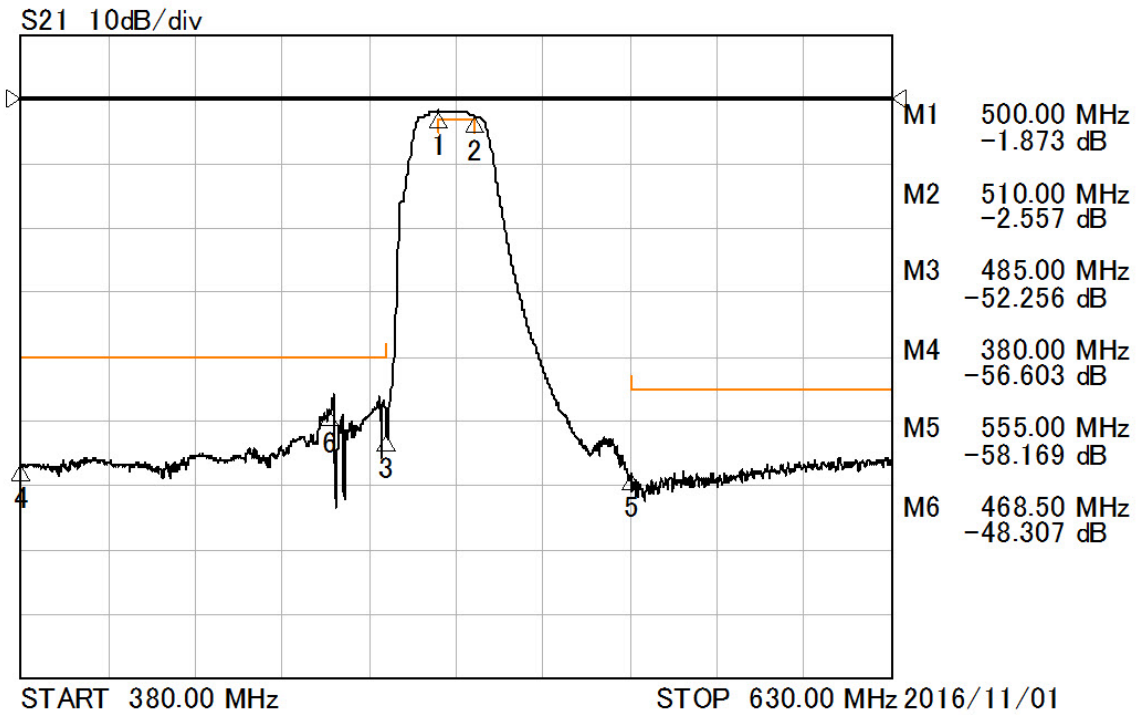

# SM3838-8 Case

## 8-Terminal Ceramic Surface-Mount Case 3.8 X 3.8mm Nominal Footprint

### Case Dimensions

Dimension	mm			Inches		
	Min	Nom	Max	Min	Nom	Max
A	3.65	3.8	3.95	0.14	0.15	0.155
B	3.65	3.8	3.95	0.14	0.15	0.155
C	-	-	1.40	-	-	0.055
D	-	1.10	-	-	0.043	-
E	-	1.0	-	-	0.04	-
F	-	0.6	-	-	0.024	-
G	-	2.54	-	-	0.100	-
H	-	1.50	-	-	0.059	-

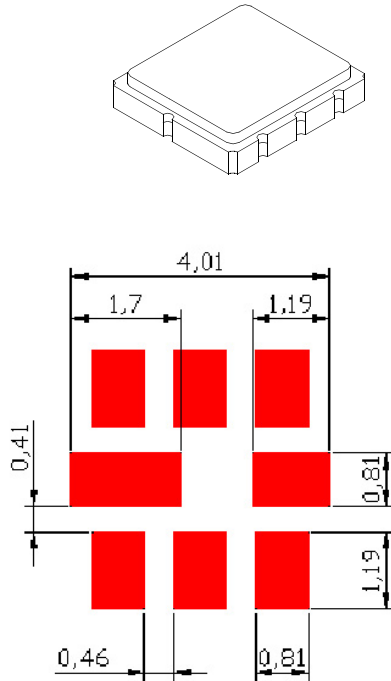

PCB Footprint

### Case Materials

Materials	
Solder Pad Plating	0.3 to 1.0 $\mu\text{m}$ Gold over 1.27 to 8.89 $\mu\text{m}$ Nickel
Lid Plating	2.0 to 3.0 $\mu\text{m}$ Nickel
Body	$\text{Al}_2\text{O}_3$ Ceramic

TOP VIEW

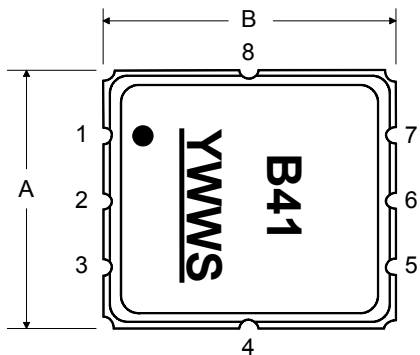

BOTTOM VIEW

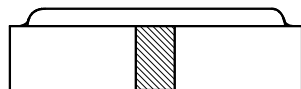
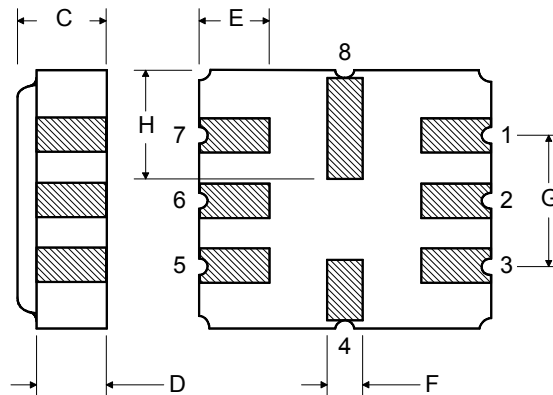

## Tape and Reel Specifications

Tape and Reel Standard per ANSI/EIA-481

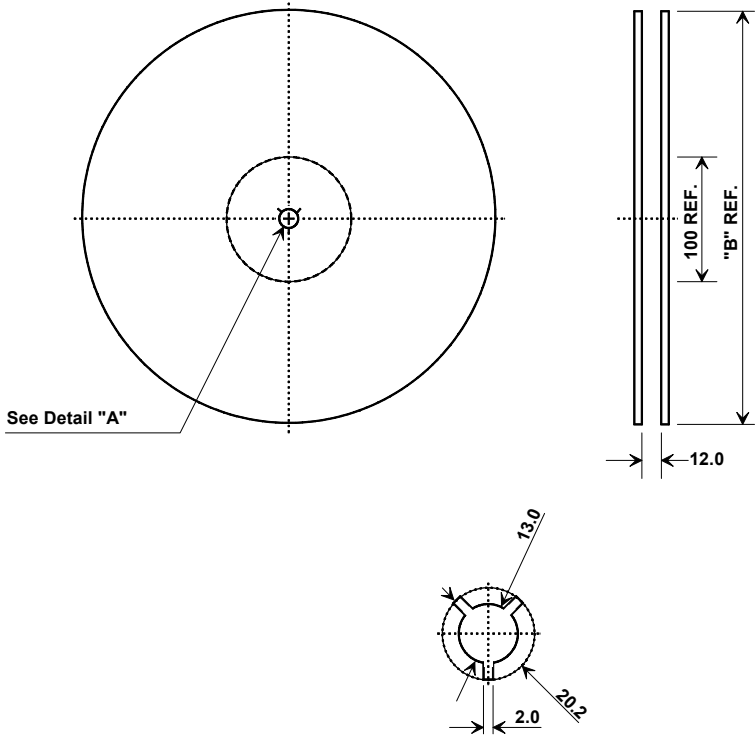

"B" Nominal Size		Quantity Per Reel
Inches	millimeters	
7	178	500
13	330	3000

### COMPONENT ORIENTATION and DIMENSIONS

Carrier Tape Dimensions	
Ao	4.25 mm
Bo	4.25 mm
Ko	1.3 mm
Pitch	8.0 mm
W	12.0 mm

