

**GLASS PASSIVATED SUPER FAST RECTIFIER**

**VOLTAGE RANGE 50 to 600 Volts CURRENT 3.0 Amperes**

**FEATURES**

- \* High reliability
- \* Low leakage
- \* Low forward voltage
- \* High current capability
- \* Super fast switching speed
- \* High surge capability
- \* Good for switching mode circuit

**MECHANICAL DATA**

- \* Case: Molded plastic
- \* Epoxy: Device has UL flammability classification 94V-O
- \* Lead: MIL-STD-202E method 208C guaranteed
- \* Mounting position: Any
- \* Weight: 1.18 g rms



**DO-201AD**

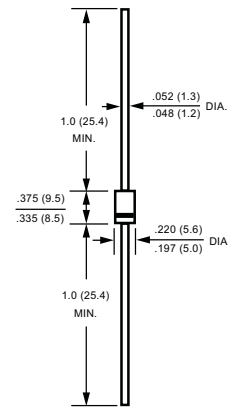

**MAXIMUM RATINGS AND ELECTRICAL CHARACTERISTICS**

Ratings at 25 °C ambient temperature unless otherwise specified.  
resistive or inductive load.

MAXIMUM RATINGS (@ TA=25 °C unless otherwise noted)

RATINGS	SYMBOL	SF31	SF32	SF33	SF34	SF35	SF36	SF37	UNITS
Maximum Recurrent Peak Reverse Voltage	VRRM	50	100	150	200	300	400	600	Volts
Maximum RMS Voltage	VRMS	35	70	105	140	210	280	420	Volts
Maximum DC Blocking Voltage	VDC	50	100	150	200	300	400	600	Volts
Maximum Average Forward Rectified Current at TA = 55°C	IO	3.0							Amps
Peak Forward Surge Current 8.3 ms single half sine-wave superimposed on rated load (JEDEC method)	IFSM	125							Amps
Current Squared Time	I <sup>2</sup> t	64.8							A <sup>2</sup> /Sec
Typical Thermal Resistance (Note 3)	RθJA	20							°CW
	RθJL	8.0							
Typical Junction Capacitance (Note 2)	CJ	50				30			pF
Operating and Storage Temperature Range	TJ, TSTG	-55 to + 150							°C

ELECTRICAL CHARACTERISTICS (@TA=25 °C unless otherwise noted)

CHARACTERISTICS	SYMBOL	SF31	SF32	SF33	SF34	SF35	SF36	SF37	UNITS
Maximum Instantaneous Forward Voltage at 3.0A DC	VF	0.95				1.25		1.50	Volts
Maximum DC Reverse Current at Rated DC Blocking Voltage	IR	@TA = 25°C							uAmps
		5.0							
Maximum Reverse Recovery Time (Note 1)	trr	100						50	nSec
		35							

- NOTES : 1. Test Conditions: IF = 0.5A, IR = -1.0A, IRR = -0.25A  
 2. Measured at 1 MHz and applied reverse voltage of 4.0 volts.  
 3. Typical Thermal Resistance : At 9.5mm lead lengths,PCB mounted.  
 4. "Fully ROHS compliant", "100% Sn plating (Pb-free)"

## RATING AND CHARACTERISTICS CURVES ( SF31 THRU SF37 )

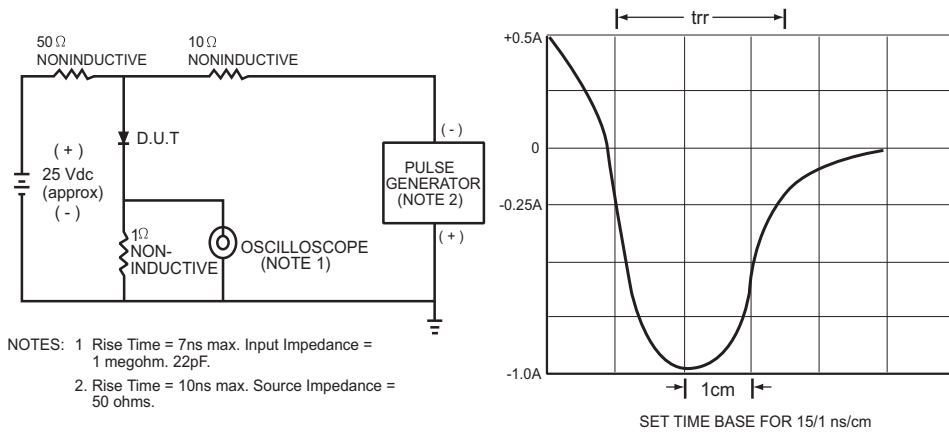

FIG.1 TEST CIRCUIT DIAGRAM AND REVERSE RECOVERY TIME CHARACTERISTIC

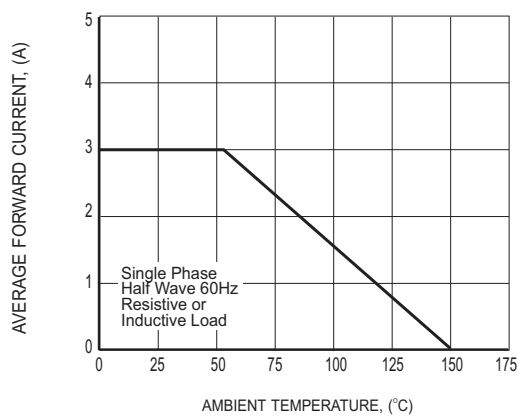

FIG.2 TYPICAL FORWARD CURRENT DERATING CURVE

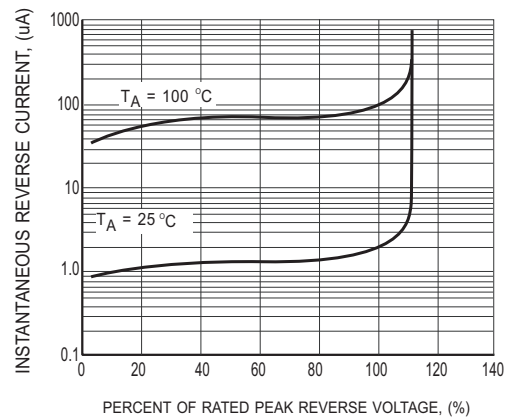

FIG.3 TYPICAL REVERSE CHARACTERISTICS

## RATING AND CHARACTERISTICS CURVES ( SF31 THRU SF37 )

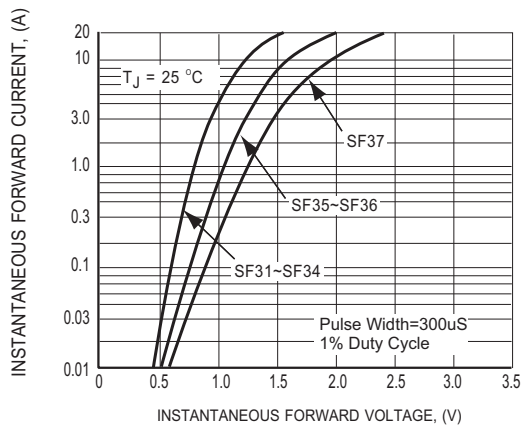

FIG.4 TYPICAL INSTANTANEOUS FORWARD CHARACTERISTICS

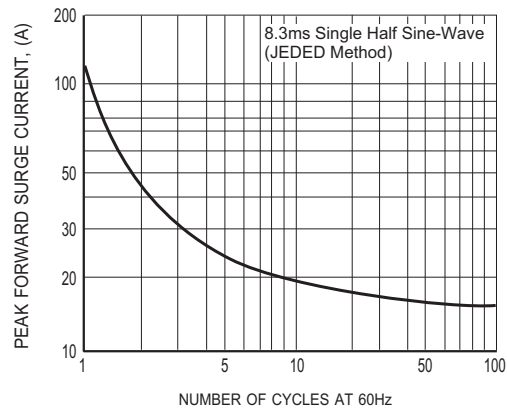

FIG.5 MAXIMUM NON-REPETITIVE FORWARD SURGE CURRENT

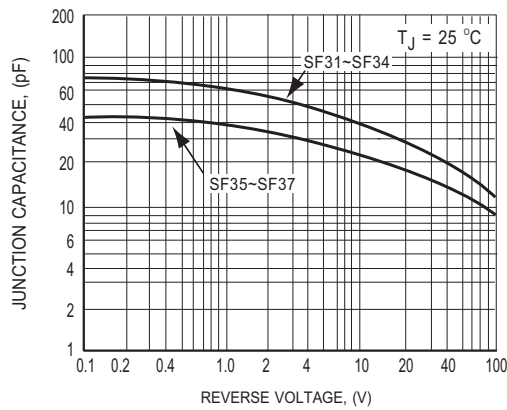
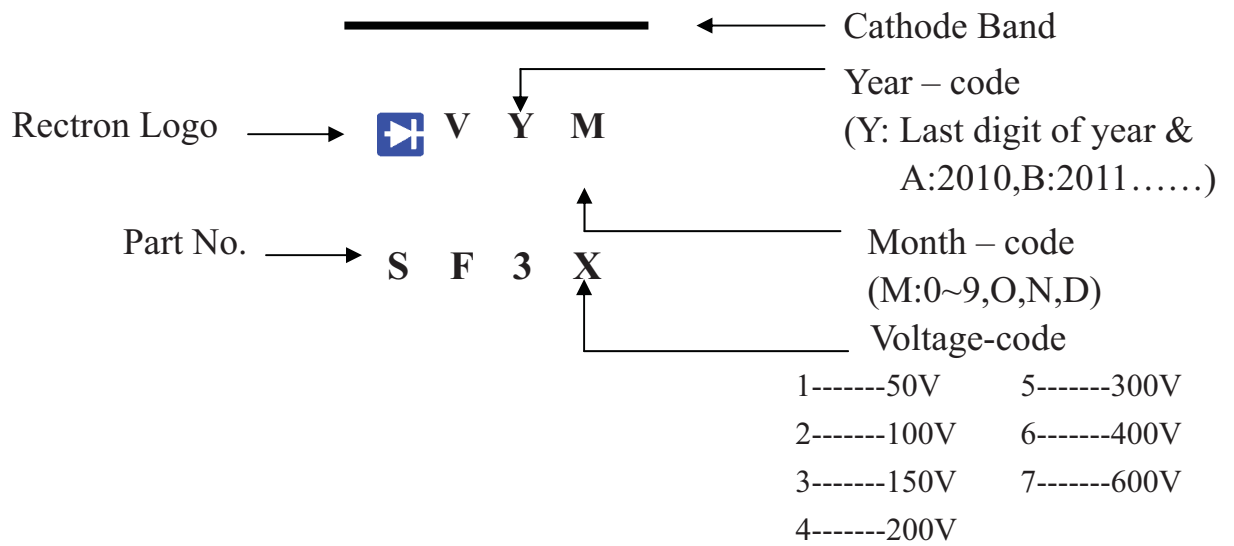

FIG.6 TYPICAL JUNCTION CAPACITANCE

## Marking Description



## PACKAGING OF DIODE AND BRIDGE RECTIFIERS

### BULK PACK

PACKAGE	PACKING CODE	EA PER BOX	INNER BOX SIZE (mm)	CARTON SIZE (mm)	EA PER CARTON	GROSS WEIGHT(Kg)
DO-201	-B	500	300*73*40	347*320*271	12,000	15.9

### REEL PACK

PACKAGE	PACKING CODE	EA PER REEL	EA PER INNER BOX	COMPONENT SPACE (mm)	TAPE SPACE (mm)	REEL DIA (mm)	CARTON SIZE (mm)	EA PER CARTON	GROSS WEIGHT(Kg)
DO-201	-T	1,200	1,200	5.0	52	330	355*350*335	4,800	9.10

### AMMO PACK

PACKAGE	PACKING CODE	REEL ( EA )	COMPONENT SPACE(mm)	TAPE SPACE (mm)	BOX SIZE (mm)	CARTON SIZE(mm)	CARTON ( EA )	GROSS WEIGHT (Kg)
DO-201	-F	600	9.5	52	255*73*100	400*268*225	6,000	9.9